

47-060-59

**Instructions for
Type URF Step Voltage Regulator**



Westinghouse Electric Corporation

Sharon Plant, Transformer Divisions, Sharon, Pa.

I. B. 47-060-59 Effective June, 1962 Supersedes I. L. 47-435-3, October, 1957

Table of Contents

GENERAL INFORMATION	Page
Application	5
Operating Limits	5
Voltage and Current Limits	5
Definition of Nameplate Values	5
Operating Ambient Temperature	5
Installation Altitude	6
Surge Protection.	6
Short Circuit Rating.	6
Potential Transformer Ratios.	7
Current Transformer Ratios	7
Overload Capacity	7
DESCRIPTION	
URF Regulator	7
Control Equipment	7
Load Tap Changer.	8
Position Indicator	10
INSTALLATION	
Receiving, Handling and Storing	10
Preparation for Installation.	10
Checking Operation of Control	11
Reduced Capacity Operation	11
Mounting, Connecting and Disconnecting the Regulator	13
Three Phase Operation	14
Mounting Control Remotely.	14
SETTINGS AND ADJUSTMENTS	
General	16
Position Indicator	16
Load Range Selection	17
Control Panel Settings	17
OPERATION	
Load Tap Changer.	18
Control Operation.	20
Position Indicator.	21
MAINTENANCE	
Inspection	21
CVR Relay Maintenance	22
Correction of Minor Troubles	22
Major Overhaul and Repair.	23
Test After Overhaul and Repair	24
Spare Parts	25

www.ElectricalPartManuals.com

SUPPLEMENTARY DATA

I.B. 47-431-7 - Voltage Regulating Relay, Type CVR



List of Illustrations

Figure		Page
1	External View of URF Regulator	5
2	Regulator Control Panel with Cover Removed from CVR Relay	8
3	URF Tap Changer with Side Panels Removed	8
4	Schematic of Geneva Gear Drive.	9
5	Valve Type Arrester Air Gap Adjustments	11
6	Typical Nameplate for URF Regulator	12
7	Single Phase Connections	14
8	Two Units, Open Delta Connected	15
9	Three Units, Delta Connected	15
10	Three Units, Wye Connected.	15
11	Disconnecting Flexible Cable from Regulator Tank	16
12	Remote Mounted Control Cabinet	16
13	Position Indicator with Load Range Selector	17
14	Typical Adjustment and Control Switches	17
15	Schematic Diagram of Typical URF Regulator	19
16	URF Internal Assembly	24
17	URF Internal Assembly - Tap Changer Side Panel Removed.	24

List of Tables

Table		
I	Preferred Voltage Ratings for Regulators.	6
II	Lightning Arrester Gap Settings	6
III	Short Circuit Rating for Load Range Selection	17
IV	Sequence of URF Tap Changer Operation	20

This instruction book has been prepared to assist the purchaser to properly install, operate and maintain the type URF Step Voltage Regulator supplied by Westinghouse. The information presented is based on the best practical judgment of Westinghouse engineers gained from design and installation of this apparatus and from reported experience of users of similar equipment.

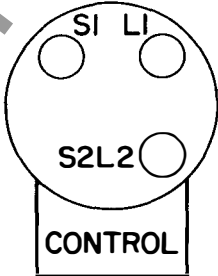
 <h1 style="margin: 0;">Westinghouse</h1> 		
KVA—CONTINUOUS 55° C. RISE	<h2 style="margin: 0;">URF</h2> <h2 style="margin: 0;">VOLTAGE REGULATOR</h2>	INSTALL AND OPERATE AS PER INSTRUCTION BOOK 47-060-59
STYLE	SINGLE PHASE 60 CYCLES	SEE INSTRUCTION PLATE INSIDE CONTROL CABINET FOR ADDITIONAL INFORMATION
VOLTAGE	BUSHING LOCATION 	CAUTION: OPERATE TO NEUTRAL AND OPEN CONTROL BREAKER BEFORE BY-PASSING
AMPERES	SERIAL NUMBER IS STAMPED IN TANK METAL BELOW THIS PLATE	
149P808HOI-A	WESTINGHOUSE ELECTRIC CORPORATION	MADE IN U. S. A.

The information appearing on the nameplate of your particular regulator may be copied in the blanks above for your convenient future reference.

Read this book before installing and operating your regulator.

General Information

APPLICATION

Westinghouse distribution type feeder voltage regulators are designed to maintain proper load center voltage by automatically correcting for changes in supply voltage and for voltage drop from the regulator to the load center. Westinghouse distribution regulators are completely automatic and self-contained.

Westinghouse URF distribution regulators are available in 2500, 5000, 7620, 13800 and 14400 volt ratings.

OPERATING LIMITS

1. Voltage and Current Limits. Standard Westinghouse distribution voltage regulators are built in line with current applicable ASA, AIEE, NEMA and EEI-NEMA Standards.

The regulators are designed to operate at rated current over a voltage range as specified in Table I. (See Table I, page 6.)

A regulator is a current rated device and this rating must not be exceeded on a continuous basis regardless of voltage.

Example, a 7620 volt, 219 ampere, 167 KVA regulator may be operated at 5000 volts at 219 amps and 109.5 KVA.

2. Definition of Nameplate Values.

(a) Rated voltage is the input voltage on which performance characteristics are based.

(b) Rated current is the allowable continuous load current at rated voltage and $\pm 10\%$ regulation.

(c) Rated KVA is rated voltage x rated current x .10/1000.

(d) Impedance - % impedance shown on nameplate is based on a line KVA of 10 x rated regulator KVA, and on regulator rated voltage and current.

3. Operating Ambient Temperature. Ambient temperature should not exceed 40°C (104°F) nor exceed an average of 30°C (86°F) in a 24 hour period.

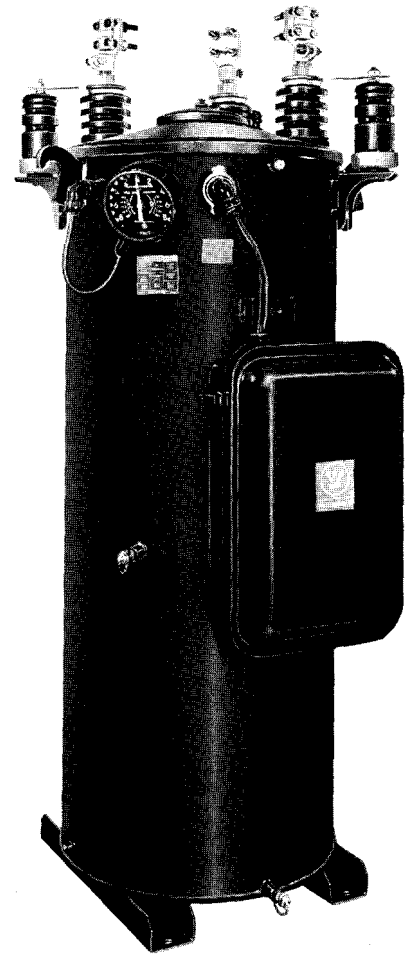

Fig. 1 - External View of URF Regulator

TABLE I
Preferred Voltage Ratings for Regulators

NOMINAL SYSTEM VOLTAGE	REGULATOR VOLTAGE RATING VOLTS	OPERATING VOLTAGE LIMITS *				
		Input Voltage - Volts			Output Voltage - Volts	
	Single Phase	Minimum	Maximum At Rated Load Amperes	Maximum At No Load	Minimum	Maximum At Rated Load Amperes or At No Load
2400	2500	2125	2625	2750	2250	2750
2400/4160Y	2500	2125	2625	2750	2250	2750
4800	5000	4250	5250	5500	4500	5500
7200	7620	6290	8000	8380	6860	8760
4800/8320Y	5000	4250	5250	5500	4500	5500
12000	12000	10200	13200	13720	10800	13720
7200/12470Y	7620	6290	8000	8380	6860	8760
7620/13200Y	7620	6290	8000	8380	6860	8760
13200	13800	11730	14500	15180	12400	15180
14400	13800	11730	14500	15180	12400	15180
14400/24940Y	14400	12240	15120	15840	12960	15840

* Includes all voltage tolerances

4. Installation Altitude. The regulator may be operated at full KVA at elevations up to 3300 feet (1000 meters). When used at higher altitudes than 3300 feet the KVA must be reduced as specified in ASA Standards.

S2L2 to ground unless this terminal has been solidly grounded.

Table II lists the proper arrester gap settings. The correct gap dimension will also be found etched in the porcelain near the bottom of the arrester.

5. Surge Protection. Standard regulators, except 14,400 volt units, are available either with or without arresters. When a regulator is purchased with De-ion® arresters, no additional surge protection is required. When a regulator is purchased without arresters, suitable protection must be provided at the time of installation.

The most reliable method of regulator protection is by means of an arrester between the S-1 terminal and ground plus a second arrester between the L-1 terminal and ground. An alternate method of protection is by means of a by-pass arrester connected between the S-1 and L-1 terminal plus a second arrester connected between either the S-1 or L-1 terminal and ground.

In addition to the above arresters, a third arrester must be connected from

TABLE II
Lightning Arrester Gap Settings

ARRESTER KV RATING	ARRESTER GAP SETTING	REGULATOR VOLTAGE RATING
3	1/4"	2500
6	3/8"	5000
10	1/2"	7620
15	3/4"	13800

The tank should be solidly grounded. The control cabinet should also be solidly grounded whenever it is mounted separately from the regulator tank.

6. Short Circuit Ratings. URF Regulators will withstand a short circuit of 25 x rated current for 2 seconds or 40 x rated current

for 0.8 second. Where system fault currents would exceed these values, use of current limiting reactors is recommended.

7. Potential Transformer Ratios. The auxiliary windings have the potential ratios indicated on the regulator nameplate. All auxiliary windings have sufficient capacity for a recording voltmeter. The nameplate in the Regulator Control Cabinet should be checked for the ratio of a particular unit.

8. Current Transformers. All URF Regulators are provided with a tapped current transformer having a secondary current rating of 0.24 amperes with 60%, 100%, or 160% rated current with the exception of those units in which 160% current is greater than 668 amperes. This current transformer is designed to operate the regulator control with ASA Class I accuracy. The addition of the usual meter burden will not appreciably affect this operation, and this

current supply may, therefore, be used to operate a thermal ampere demand indicating or recording ammeter for load checking. It is not intended, however, that this current transformer be used for metering.

The 60 percent ratio is to permit full load compensation at 60 percent of rated current and the 160 percent ratio for the higher currents associated with Load Range Selector operation of the regulator.

Selection of the proper current transformer ratio is made by use of the Current Selector switch on the control panel. A tabulation on the instruction nameplate indicates the proper ratio to be used for a given operating condition.

9. Overload Capacity. URF Regulators may be overloaded in accordance with ASA Guides C57.95.

Description

The URF Regulator provides voltage regulation of 10% above and below incoming or source voltage in sixteen 1-1/4% steps. The regulator is complete including oil and is ready for installation. Devices mounted on the tank include the position indicator, the control cabinet, and provision for sampling and draining the tap changer compartment and the main tank oil independently of each other.

The regulating transformer, preventive-auto, current transformer and load tap changer are mounted as an assembly in a common end frame and lowered into the tank as a complete unit. An auxiliary winding on the regulating transformer supplies control power and voltage.

CONTROL EQUIPMENT

Figure 2 shows the URF control equipment which is mounted on a hinged glass rein-

forced polyester panel housed in a weather-proof control cabinet which in turn is mounted on the regulator. A plug type connector is used to connect the control cabinet to the control components in the main tank making it easy to remove the control cabinet for remote mounting. Flexible control lead assemblies of various lengths, complete with a plug-type connector are available for this purpose. The only wiring required at the installation site is to cut the cable to the exact length desired, install terminals on the conductors and connect them to the block in the cabinet.

The URF Regulator control equipment is designed around the CVR Voltage Regulating Relay. The CVR Relay is mounted in the regulator control cabinet. The major components of the CVR Relay are an induction disk type voltage sensing element, two pilot relays, two auxiliary relays, and a reactor. All components are in a draw-out chassis so that the complete relay may

be interchanged between units or removed for testing and inspection. The Flexitest switch base is made an integral part of the CVR Relay to facilitate connecting and testing the relay.

The case in which the CVR Relay is mounted for the URF regulator control is equipped with the mating portion of the Flexitest switches.

The function of and more detailed information on the controls are given in Part IV under Settings and Adjustments.



Fig. 2 - Regulator Control Panel with Cover Removed from CVR Relay

LOAD TAP CHANGER

The controlled, shockless, fast action of the URF tap changer is obtained by use of a direct Geneva gear drive mechanism (see Figures 3 and 4).

Successive taps of the regulating winding are connected to stationary contacts arranged in two circles on a Micarta® insulating panel which forms the back wall of the tap changer. A central contact in each circle is connected to one end of the

preventive auto-transformer. The moving contact for each circle bridges from the center contact to the successive tap contacts as it is rotated by a shaft from the operating mechanism.

In changing taps, starting with both moving contacts connected to the same tap, one moving contact rotates to the next tap or stationary contact while the other moving contact remains stationary. In this position, the two ends of the preventive auto-transformer are connected to adjacent taps of the regulating transformer series winding. This is known as a bridging position. The preventive auto-transformer is designed to operate continuously in this manner. To make the second tap change, the other moving contact is moved to the next tap to short the preventive auto-transformer by connecting both ends to the same tap of the regulator series winding.

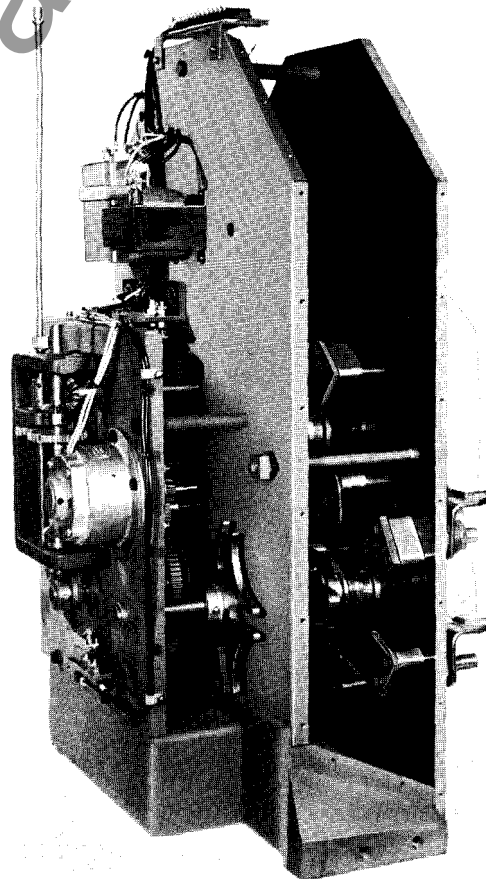

Fig. 3 - URF Tap Changer with Side Panels Removed

The selector switch stationary contacts are tipped with a special arc resisting alloy. The moving contacts are self-aligning contacts made of sintered-tungsten alloy.

A reversing switch automatically connects the series winding of the regulating transformer to either raise or lower the output voltage.

When the tap changer is on the "Lower" positions, the reversing switch connects lead TC2 to lead 8. On "Neutral" and in the "Raise" positions the reversing switch connects TC2 to 3. The reversing switch changes from 3 to 8 while both selector switches are on tap number TC2 so that the reversing switch does not break load current. (See Figure 6.)

The mechanism is powered by a 1/30th horsepower capacitor type motor which is directly geared to a Geneva pinion. For a single tap change the Geneva pinion makes 1/2 revolution but the Geneva gear and tap changer contact moves only 1/5 revolution. Because the moving contact arm is locked in position during much of the movement of the Geneva pinion, it is not necessary that the motor and Geneva pinions stop in an exact position. They may drift within liberal limits without moving the tap changer contacts. A brake consisting of a spring-loaded arm riding on a figure eight-shaped cam insures that the Geneva pinion will stop within these limits.

Figure 4 illustrates the operation of the Geneva Gears in the tap changer mechanism. It should be noted that the Geneva pinion "A", is positively geared to the operating motor at all times. To make a tap change the following sequence of operation is followed:

Illustration 1. Prior to any movement, the two Geneva gears "E" and "F" are locked into position at points "B" by pinion "A". This means that the contacts cannot move except when an actual tap change is in progress.

Illustration 2. Pinion "A" has made one-quarter revolution and pin "C" has entered slot "D" and has caused Geneva gear "E" to rotate 36 degrees from position shown in (1), bringing the moving contact to a point halfway between the stationary contacts.

Illustration 3. Pinion "A" has completed one-half revolution. Slot "D" has rotated 72 degrees from position shown in (1) and is now locked onto the next stationary contact. This constitutes one complete tap change or a 1-1/4% step.

Illustration 4. Pin "C" has entered slot "G" on Geneva gear "F" and will cause another tap change to be made similar to that described in (2) and (3). When pinion "A" returns to the position shown in (1), it will have changed the voltage 2-1/2% in two 1-1/4% steps.

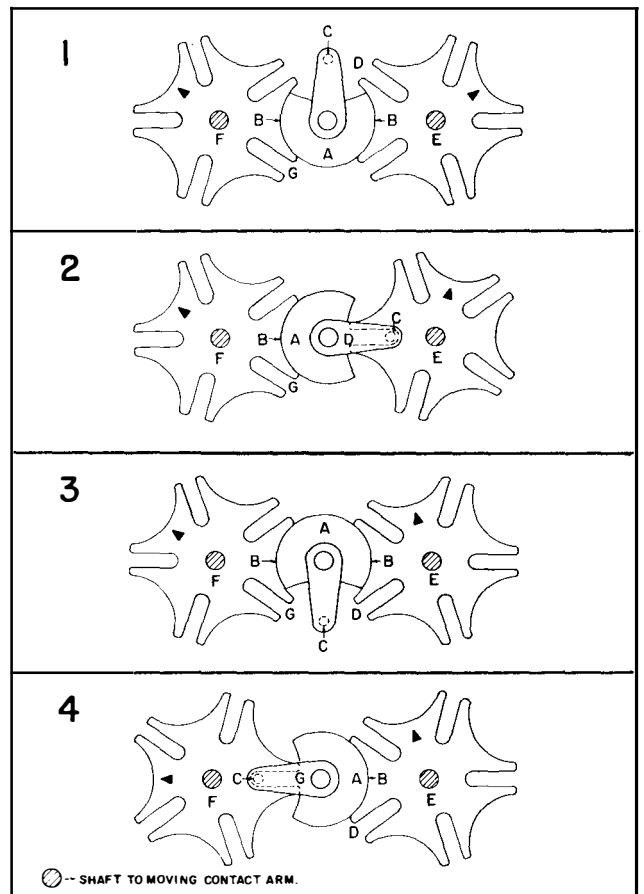

Fig. 4 - Schematic of Geneva Gear Drive

The tap changer is enclosed to prevent the free inter-change of tap changer oil with transformer oil. It is bolted securely to braces on the vertical uprights of the internal assembly. A sump at the bottom of the tap changer collects sediment and permits complete drainage of the tap changer compartment through a drain pipe which extends through the outside wall of the regulator.

Cam operated limit switches prevent the tap changer from going beyond the limits in either direction. Another switch operated by a cam on the Geneva pinion shaft works in conjunction with the control relays to operate the motor and stop the contact arm on position.

POSITION INDICATOR

The URF Regulator is equipped with a position indicator which shows the tap changer position at any time.

Resettable maximum-minimum indicating hands show the range over which the tap changer has operated since it was last reset.

"Load Range Selector" limit switches are incorporated into the position indicator. These limit switches may be set by means of knobs outside the indicator housing to limit the range of regulation to 5, 6-1/4, 7-1/2, 8-3/4, or 10% raise or lower. Separate settings are provided for raise and lower limits.

Installation

RECEIVING, HANDLING AND STORING

URF Step Voltage Regulators are shipped completely assembled. Immediately on receipt, shipments should be checked for possible damage or shortages. Any shortage or damage should be reported to the transportation company.

The URF Regulators may be lifted by means of lifting lugs welded to the tanks.

These regulators are built for outdoor service, therefore, no unusual storage precautions are necessary. It is preferable to store them in locations where the humidity is not extremely high.

PREPARATION FOR INSTALLATION

The URF Step Voltage Regulator has been carefully inspected and tested at the factory before shipment; however, it should be inspected prior to installation, observing the following items:

1. Test a sample of the oil from the regulator in a standard oil test cup. Oil suitable for use in a regulator should test at least 26 KV. In no case should a transformer or regulator be energized when the oil tests less than 22 KV. If moisture is indicated, the oil should be removed and filtered and the unit should be dried. Oil removed from the regulator should be replaced with clean dry oil. Before energizing the regulator check to insure that the oil level is up to the cold oil level stenciled on the inside of the tank wall.
2. If lightning arresters are furnished, the air gap should be set at the spacing stenciled on the arrester porcelain. See Table II for gap settings when mounting the arresters on the tank. Adjustments are provided in both the vertical and horizontal directions. See Figure 5.
3. The URF Regulator is shipped with the tap changer on neutral position. The internal connections for various tap changer positions are shown on the nameplate located in the control cabinet. Figure 6 shows a typical nameplate.

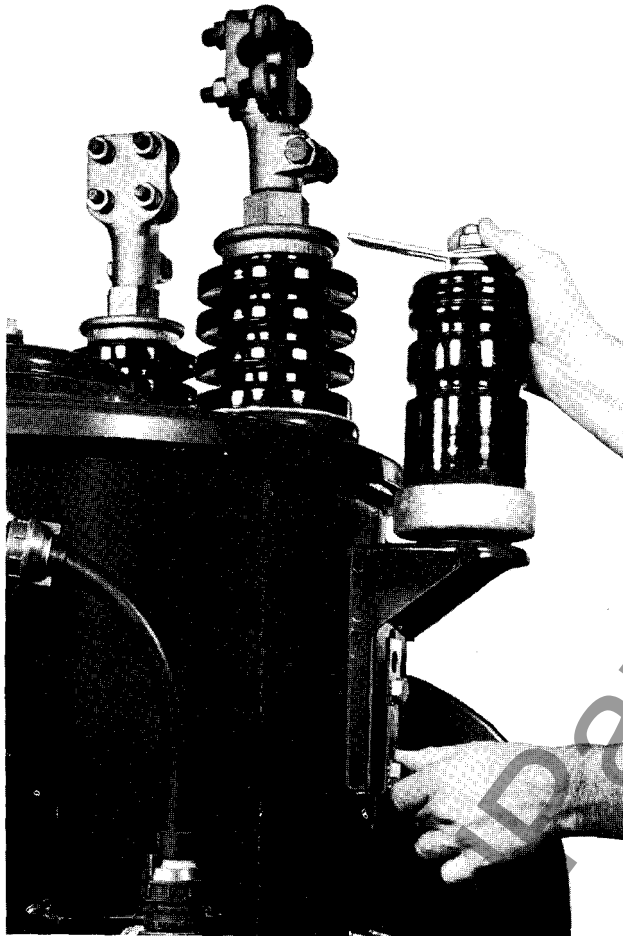

Fig. 5 - Valve Type Arrester
Air Gap Adjustments

4. Before operating, the blocking should be removed from the type CVR Voltage Regulating Relay.

Make sure that all parts of the CVR Relay operate freely and inspect the contacts to see that they are clean and close properly.

CHECKING OPERATION OF CONTROL

Electrical tests can be made by applying a variable voltage source to the test terminals of the control panel.

NOTE: Be sure the control circuit breaker is in the off position and the link G to TT2 is dis-

connected before applying test voltage. Otherwise the regulator may be energized thru the potential circuit producing high voltages. Do not use more than 10 ampere fuses in the supply circuit.

The following sequence of tests is recommended.

A. Apply 120 volts (or the voltage at which the voltage regulating relay is balanced) to the test terminals and then place the control selector switch on the Raise or Lower position. The tap changer will run to the raise or lower limit without pause depending on whether the control selector switch is left on the Raise or Lower position. Return tap changer to Neutral position.

B. Place the control selector switch on Auto and reduce the voltage two volts below the balance voltage. After a time delay the CVR Relay contacts will close and the tap changer will operate in the raise direction with a short pause between steps until the limit position is reached.

NOTE: Bear in mind that the relay is not regulating the external voltage; therefore, the voltage on the CVR Relay is unchanged and the tap changer will operate until a limit position is reached.

C. Now raise the voltage to two volts above the balance voltage and a similar sequence of operations will take place in the lower direction.

REDUCED CAPACITY OPERATION

All standard 5000, 7620 and 13,800 volt URF regulators are provided with taps in the auxiliary winding for operating the regulator at reduced voltage. When operated at reduced voltage the current rating of the regulator must not be exceeded. The correct control voltage is obtained by movement of a Faston tab on the terminal block under the handhole cover. Refer to the wiring diagram and regulator nameplate for proper control connections. The exact

Westinghouse®



7620 VOLTS
219 AMPS
167 KVA
60 CYCLE
IMPEDANCE %
AT 1670 LINE KVA
WITH TAP CHANGER ON POS. 8R

SINGLE PHASE
TYPE URF
VOLTAGE
REGULATOR
CLASS 0A

FULL LOAD CONTINUOUSLY
55°C. RISE
GALLONS OIL
TAP CHANGER
TRANS. TANK
STYLE
SERIAL

INSTRUCTION BOOK

CONTROL WIRING DIAGRAM

FULL WAVE IMPULSE TEST LEVEL: KV.

APPROX. WEIGHT IN LBS. CORE AND COILS CASE OIL TOTAL

MADE IN U.S.A.

WESTINGHOUSE ELECTRIC CORPORATION

119P591HOI-A

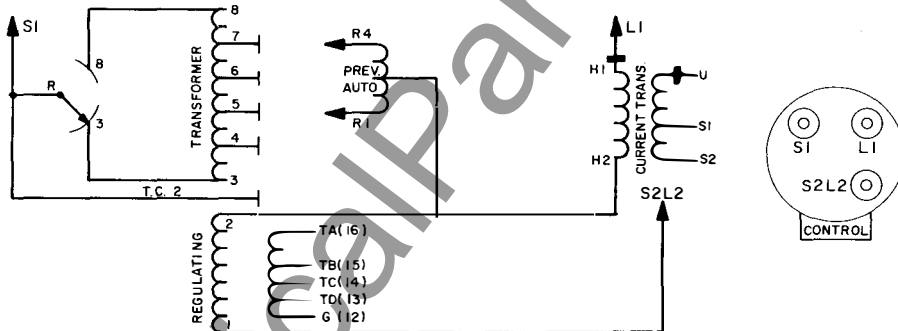

VOLTAGE — TAP CHANGER POSITION						
VOLTS LI-L2 (LOAD) = 100%						
TAP CHANGER POSITION	% VOLTS (S1-S2) SOURCE	CONNECTS			TAP CHANGER POSITION	% VOLTS (S1-S2) SOURCE
9L	110	R	RI	R4	N	100
7L	108 3/4	8	4	4	1R	98 3/4
6L	107 1/2	8	4	5	2R	97 1/2
5L	106 1/4	8	5	6	3R	96 1/4
4L	105	8	6	6	4R	95
3L	103 3/4	8	6	7	5R	93 3/4
2L	102 1/2	8	7	7	6R	92 1/2
1L	101 1/4	8	7	TC2	7R	91 1/4
N	100	3	TC2	TC2	8R	90

LOAD RANGE SELECTION OPERATION					
POSITION INDICATOR SWITCH SETTING	MAXIMUM LINE AMPERES	OPERATING RANGE POSITIONS	C.T. CONNECTIONS BY "CS" SWITCH		C. T. RATIO
			POSITION	LEADS	
10 %	219	8R-8L	100 %	U-S1	219/.24
8 3/4 %	241	7R-7L	160 %	U-S2	350/.24
7 1/2 %	263	6R-6L			
6 1/4 %	296	5R-5L			
5 %	351	4R-4L			

C.T. DATA FOR FULL LOAD LINE DROP COMPENSATION AT 60% LOAD

ANY SETTING	131	ANY RANGE	60 %	S1	S2	131/.24
-------------	-----	-----------	------	----	----	---------

LINE VOLTS LI-L2	REDUCED VOLTAGE OPERATION				CONTROL VOLTS	
	T2	CONNECT	X1	TO		
7960	G	TA	TB	TC	TD	116.1
7620				14	13	12.7
7200				14		12.0
6900				15	14	11.5
6000				15		12.5
2500				16		12.5

REGULATING TRANS. L638029
PREVENTIVE AUTO. L653972
CURRENT TRANS. L690347
TO BY-PASS REGULATOR, OPERATE TO NEUTRAL POSITION AND OPEN CONTROL CIRCUIT BREAKER BEFORE CLOSING BY-PASS SWITCH.

Fig. 6 - A Typical Nameplate

control voltage ratios are indicated on the regulator nameplate inside the control cabinet. See Figure 6, page 12, for a typical nameplate.

For a typical 2500 volt regulator lead X1 would be connected to terminal 16 (lead TA) on the terminal block for the ratio of 2500 to 125.

In a typical 5000 volt regulator (which has additional taps in the regulator auxiliary winding), for 5000 volt operation connect lead X1 to terminal 14 (lead TC). For 4330 volt operation connect lead X1 to terminal 15 (lead TB). For 2500 volt operation connect lead X1 to terminal 16 (lead TA) on the terminal block.

In the typical 7620 volt regulator lead X1 is connected to terminal 13 (lead TD) for use on a 7960 volt line. Lead X1 is connected to terminal 14 (lead TC) for use on a 7620, 7200 or 6900 volt line. Lead X1 is connected to terminal 15 (lead TB) for use on a 5000 volt line and lead X1 is connected to terminal 16 (lead TA) for a 2500 volt line.

In the typical 13,800 volt regulator lead X1 is connected to terminal 13 (lead TD) on the terminal block for 14,400, 13,800, and 13,200 volt operation. However, for 12,000 volt operation lead X1 is connected to terminal 14 (lead TC) on the terminal block. Lead X1 is connected to terminal 15 (lead TB) for use on a 7960 line. Lead X1 is connected to terminal 16 (lead TA) for use on a 7620, 7200 or 6900 volt line.

The control voltage is not the same for all these connections. This must be considered in setting the balance voltage of the CVR Relay.

NOTE: The operator should always use the nameplate information to make these connections rather than to use the typical connection cited in the instruction book.

MOUNTING, CONNECTING AND DISCONNECTING THE REGULATOR

The URF Regulators are provided with a base having four mounting holes for bolting to a pad or platform.

For operating convenience combination disconnecting and by-passing switches or at least three disconnect switches should be used for connecting, disconnecting and by-passing the regulator. This facilitates installing and servicing the regulator without taking the line out of service. In general it is desirable to use a fourth disconnect between S2L2 and the common line, or neutral so that the unit may be completely isolated from the lines when being serviced.

In some cases the S2L2 disconnect may not be required. This must be determined by system rules and by the conditions of grounding on the system.

CAUTION: When connecting a regulator to the line it is extremely important that the regulator be operated to **NEUTRAL** position. If this is not done there is danger of a short circuit on the series winding of the regulator. The following procedure should be followed when connecting the regulator to a line without removing the line from service.

1. Operate the Quicklag breaker on the control panel to the open position and the Control Selector Switch to the OFF position.
2. The neutral disconnect should be closed or a solid connection made to the system neutral.
3. Close the source disconnect switch. The regulator is now energized.
4. At this point the control panel and voltage regulating relay settings should be made, following settings and adjustments. See I.B. 47-431-7. This can be done either by using a separate voltage source or by using the control voltage obtained from the energized regulator.
5. After completing step 4, operate the load tap changer to the neutral or by-pass position. Open the Quicklag breaker if it was closed in step 4 above.

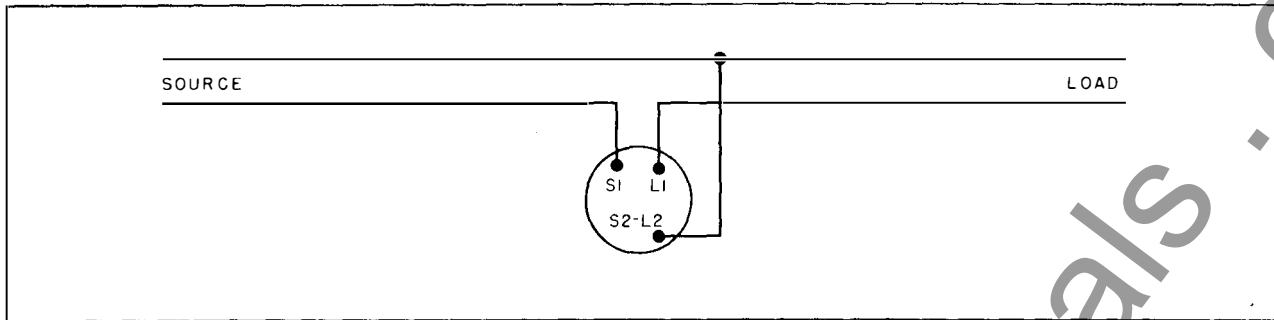

Fig. 7 - Single Phase Connections

6. Close the load disconnect switch.
7. Open the by-pass switch.
8. With the adjustments and settings made, the Quicklag breaker may be closed and the control switch set for automatic operation. The URF regulator will now operate to maintain load center voltage at the desired level.

The following procedure permits disconnecting the regulator without interrupting load:

1. Operate the tap changer to neutral position by means of the Control Selector Switch.
2. Open the Quicklag breaker to de-energize the control circuit.
3. Close the by-pass switch.
4. Open the load disconnect switch.
5. Open the source disconnect switch. The neutral may now be disconnected. Where a combination by-pass and disconnect switch is used, the regulator must be on neutral position before this switch is operated.

THREE PHASE OPERATION

For 3-phase, 3-wire circuits, two single phase units may be used in open delta, or three single phase units may be connected in closed delta. When three regulators are connected in a closed delta bank, the bank will provide approximately plus or minus fifteen percent range of regulation with an

accompanying phase shift. The bank current capacity is the same as the single phase current rating.

Single phase URF Regulators are insulated for operation in banks of three units connected in wye on 3-phase, 4-wire circuits, provided the neutral of the regulator bank is connected to the system neutral, regardless of whether or not the system neutral is grounded. If the system neutral is not available the URF Regulators must not be connected in wye. When connected for 3-phase operation each regulator operates independently from the other regulators in the bank and may be treated as a single phase unit and directions for bypassing are the same as for single units. These connections are illustrated in Figures 8, 9 and 10.

MOUNTING CONTROL REMOTELY

It is sometimes desirable to locate the control cabinet remotely for convenience in servicing and inspecting the control. To do this proceed as follows:

1. Operate regulator to Neutral and open the Quicklag breaker.
2. By-pass the regulator.
3. Disconnect the flexible lead from the tank and from the control cabinet.

CAUTION: The control cable contains current transformer leads which must not be disconnected while the unit is carrying a load.

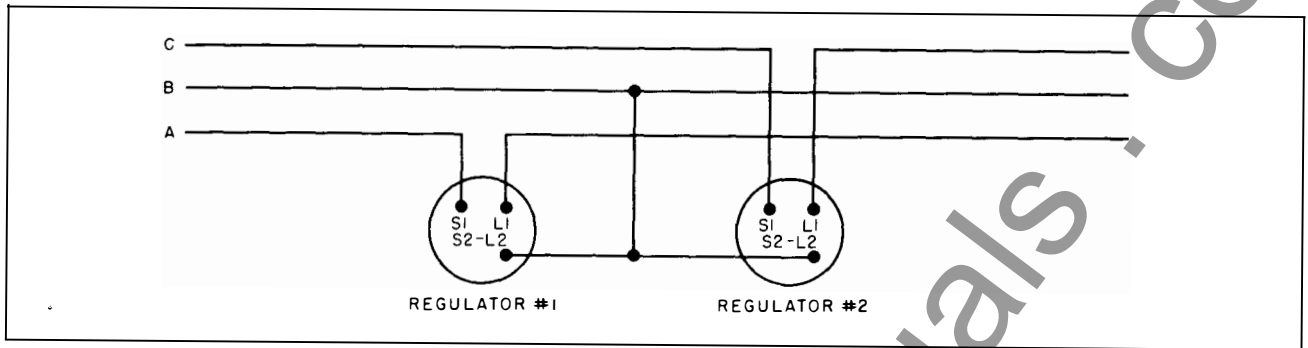

Fig. 8 - Two Units, Open Delta Connected on a Three Phase, Three Wire Circuit - Phase Sequence ABC

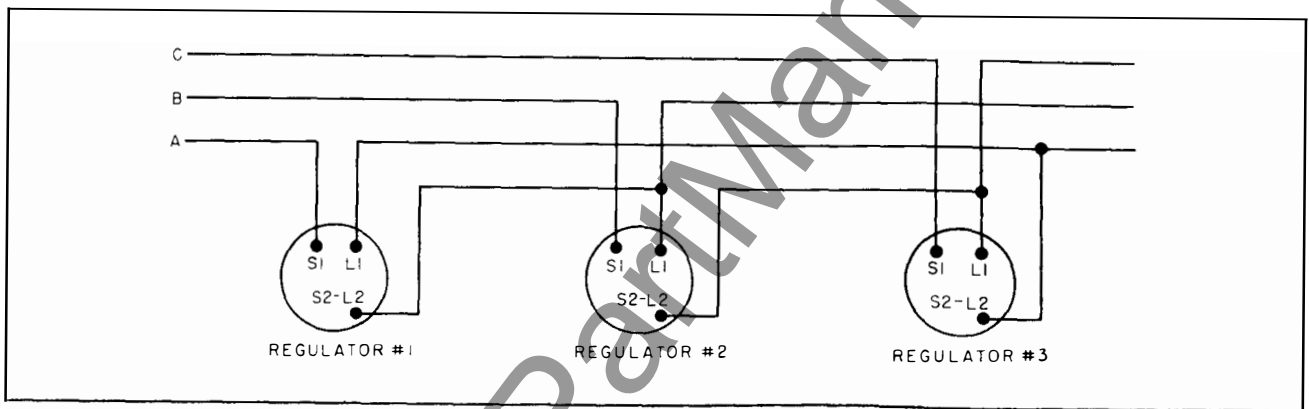

Fig. 9 - Three Units, Delta Connected, on a Three Phase, Three Wire Circuit - Phase Sequence ABC

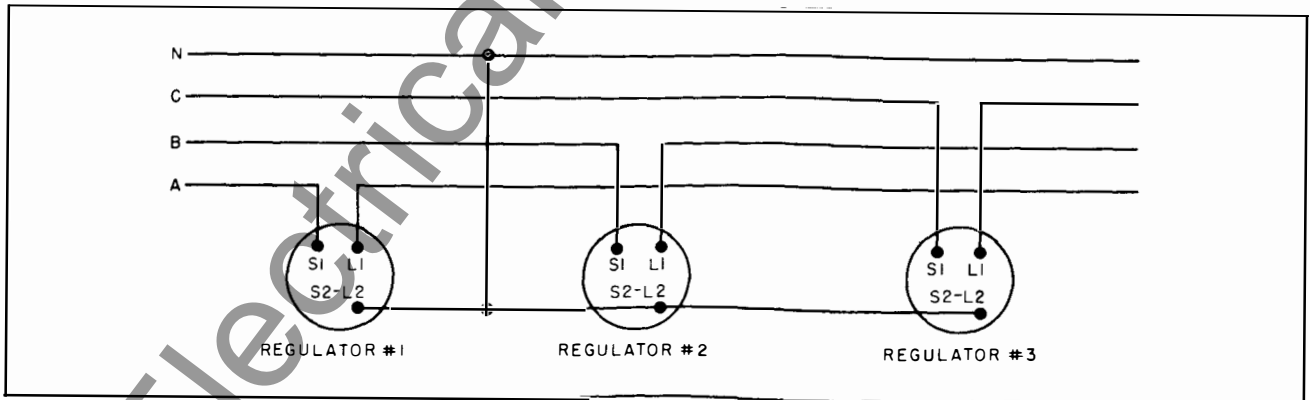

Fig. 10 - Three Units, Wye Connected, on a Three Phase, Four Wire Circuit - Phase Sequence ABC

4. Remove the control cabinet from the regulator tank.

5. Mount the control cabinet to the pole in the selected location and solidly ground it.

6. Plug an appropriate length cable into the tank connector, connect lower end to

control cabinet terminal block and tighten cable clamp. Connector cables may be purchased from the Renewal Parts Section, Sharon Plant where they are stock items in 5 ft. increments of length.

7. Re-energize the regulator.

8. Place the Control Selector on "Auto".



Fig. 11 - Disconnecting Flexible Cable from Regulator Tank

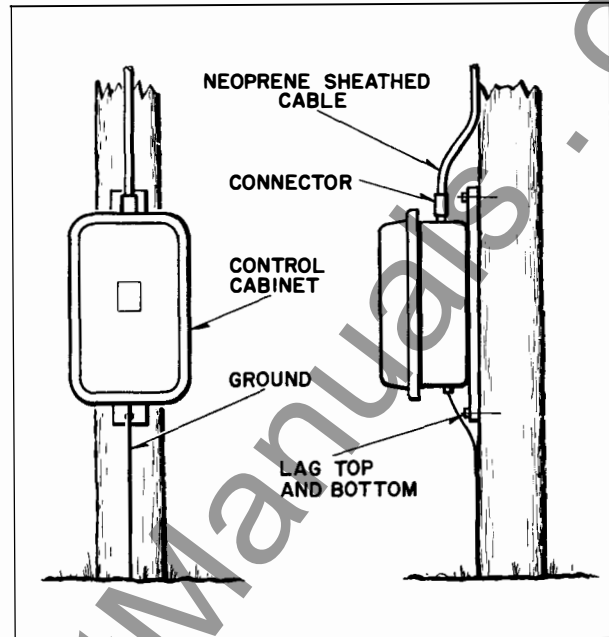

Fig. 12 - Remote Mounted Control Cabinet

Settings and Adjustments

GENERAL

All settings and adjustments to be made on the URF Regulator are on the control panel except for the Load Range Selector Settings on the position indicator. The settings that can be made are voltage level, bandwidth, time delay, reactance and resistance line drop compensation, line drop compensator polarity and current transformer ratio. Voltage level, bandwidth and time delay setting and/or adjustments are made within the voltage regulating relay itself. Reactance and resistance line drop compensation, current transformer ratio selection, and line drop compensator polarity settings are made by use of rheostats or tap switches, mounted on the control panel. See I.B. 47-431-7.

The main difference between the CVR Control described in I.B. 47-431-7 and the URF Regulator CVR Control is that the AR and AL relays of the CVR energize

the R and L Contactors in the URF Regulator to operate the motor in the raise or lower direction rather than to operate the motor directly.

POSITION INDICATOR

The URF position indicator shows the position of the tap changer. A pair of red maximum and minimum position indicating hands shows the maximum range over which the tap changer has operated since the indicator was last reset.

These maximum-minimum indicating hands are reset by depressing a large spring loaded plunger in the bottom of the position indicator. A hot stick or suitable pole may be used to depress the reset plunger from the ground on platform mounted regulators. (For current rating data refer to Table III.)

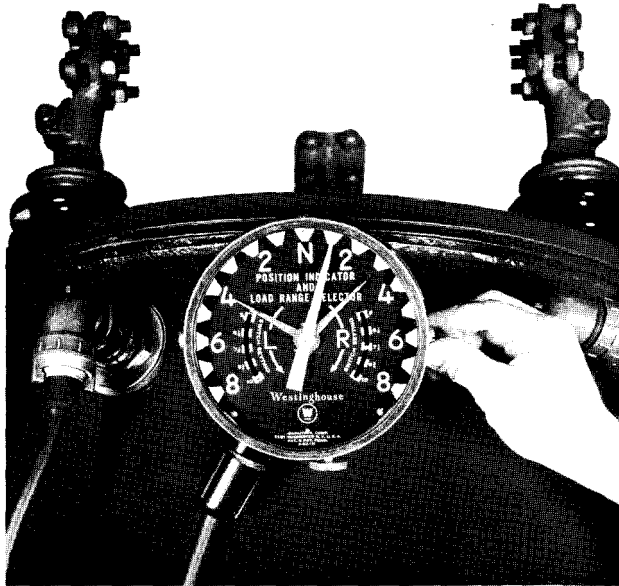

Fig. 13 - Position Indicator with Load Range Selector

LOAD RANGE SELECTION

Load Range Selection limit switches are built into the position indicator. They may be set to limit the range of regulation to values other than plus or minus 10%. The raise and lower ranges are independently adjustable by means of knobs at the sides of the position indicator assembly. To change the range of regulation, depress the knob and turn it. The new range of regulation will be shown by indicators which may be seen through calibrated slots in the indicator dial. When Load Range Selection Operation is to be set up, a current

TABLE III
Load Range Selection

POSITION INDICATOR LIMIT SWITCH SETTING	% RATED LINE AMPERES *	OPERATION RANGE - POSITIONS
10%	100	8R to 8L
8-3/4%	110	7R to 7L
7-1/2%	120	6R to 6L
6-1/4%	135	5R to 5L
5%	160	4R to 4L

* This current limit must not exceed 668 Amperes.

transformer ratio is to be selected by use of the Current Selector Switch on the control panel. See Instruction Plate for ratio to be used.

CONTROL PANEL SETTINGS

The Test Voltage Rheostat Control is a combination motor circuit interlock switch

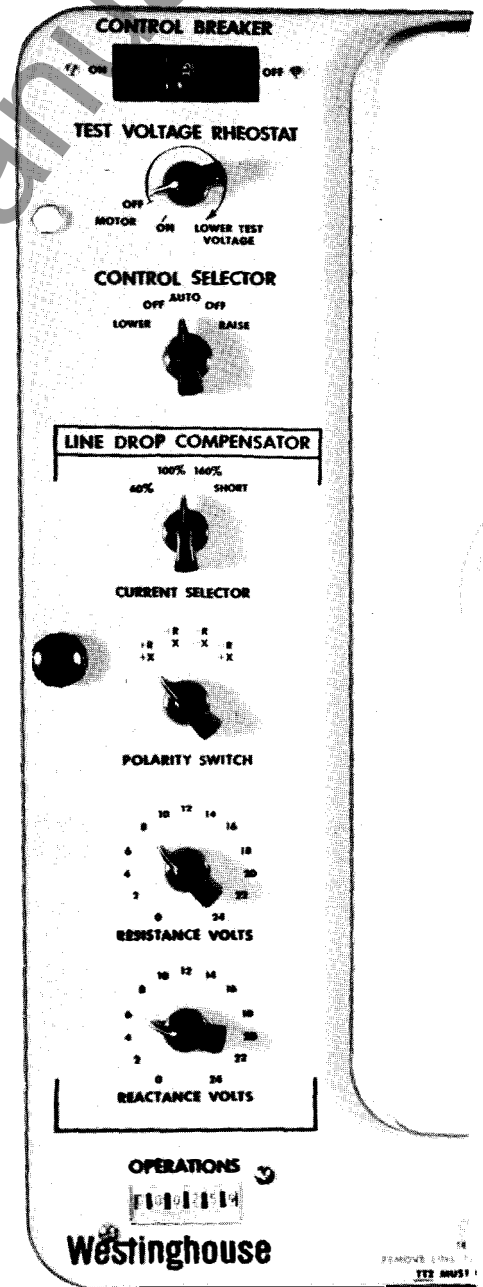

Fig. 14 - Typical Adjustment and Control Switches Associated with the CVR Relay

and voltage adjusting rheostat. The knob is in the MOTOR-ON position for normal operation. With the knob on or past the MOTOR-OFF position, auxiliary voltage is applied to the control circuit through the voltage adjusting rheostat. This rheostat provides a means of varying the voltage applied to the control for test purposes. When on or past the MOTOR-OFF position the motor circuit interlock switch is open, preventing the tap changer from operating in response to voltage variations caused by use of the rheostat.

The five position control selector switch, LOWER-OFF-AUTO-OFF-RAISE serves as a combination automatic-manual and raise lower switch. When the switch is on AUTO position, the regulator is on fully automatic operation. When the switch is turned to any other position, the regulator is being manually controlled.

The regulator is equipped with line drop compensation set by the four knobs on the

lower left portion of the control panel. The Resistance and Reactance Volts settings determine the resistance or reactance volts inserted into the control circuit when rated line drop compensation current is flowing. The Current Selector Switch connects proper taps of the current transformer so that rated current flows in the line drop compensator when the line current through the regulator is 60%, 100% or 160% of the nameplate current rating. The switch should always be on the short position when the CVR relay is removed from its case.

The polarity switch is set on the + R + X position for normal operation, on + R - X for paralleling units by reverse reactance, and on any position as required by the Wagner scheme for operation of units in delta or open delta.

Detail instructions for setting the line drop compensation are outlined in I.B. 47-431-7.

Operation

LOAD TAP CHANGER

A diagram of connections of the typical URF Regulator is shown schematically in Figure 15. For any particular regulator the diagram listed on the regulator instruction plate should be used for detail connections. The instruction plates do not show the control circuit connections. The taps from the regulating transformer windings are brought to load tap changer contacts for automatic $\pm 10\%$ regulation.

The selector switches perform all the load switching operations. All arcing is confined to these switches. In a typical sequence of operations starting with both moving contacts on terminal TC-2 (neutral

position on the position indicator), operation of the motor in the lower direction causes the 120 switch to close. As soon as the 120 switch closes the tap changer runs automatically until one moving contact stops on tap 7 while the other contact remains on terminal TC-2. This is position 1 Lower on the position indicator. The reversing switch moves from 3 to 8 before selector arm R1 moves from contact TC-2 to 7 and connects the series winding for lowering the load voltage from the source voltage. The next operation of the tap changer moves the other contact from tap TC-2 to tap 7. This is position 2 Lower on the position indicator. The complete sequence of operation is outlined in Table IV.

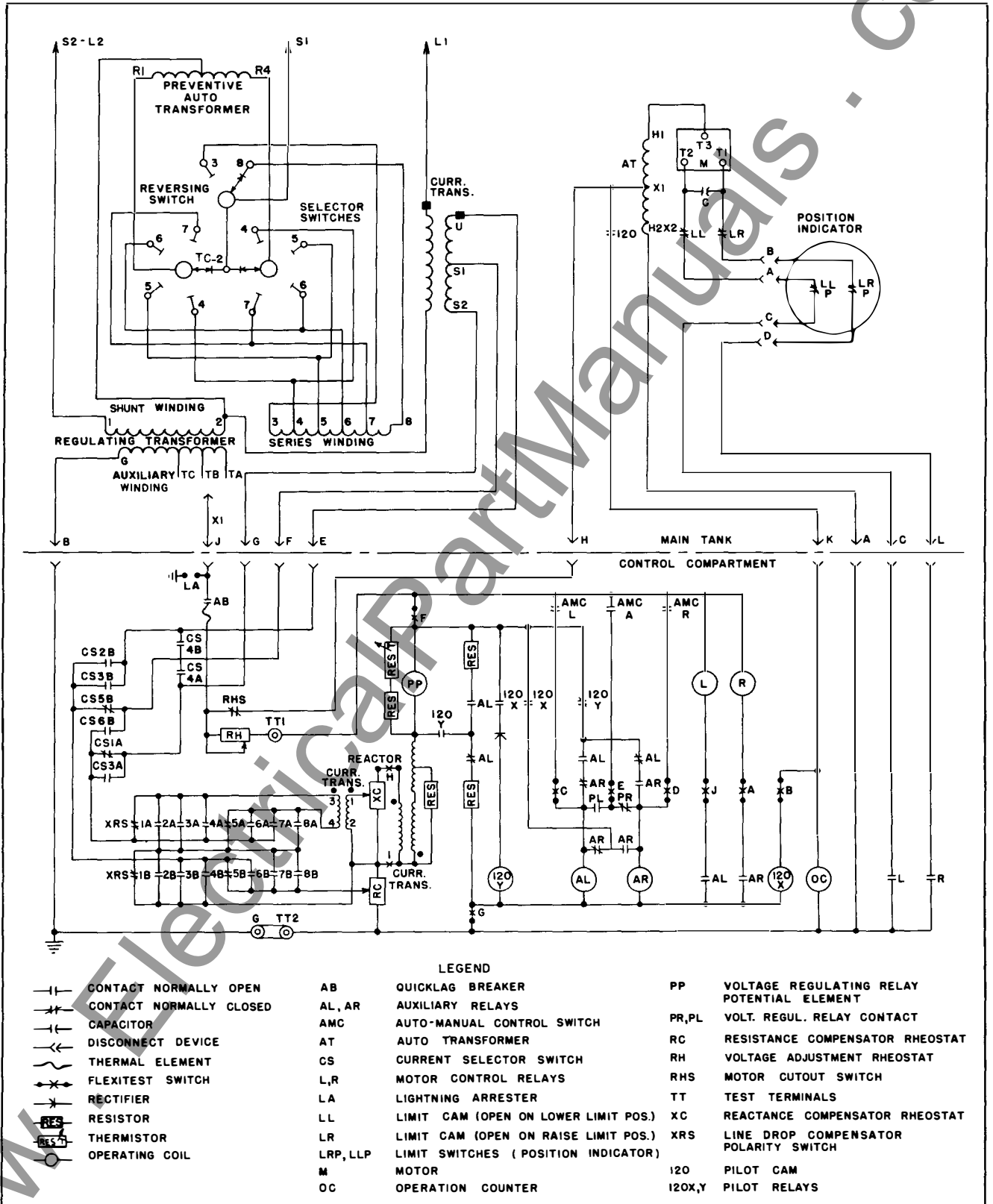

Fig. 15 - Schematic Diagram of Typical URF Regulator

TABLE IV
Sequence of URF Tap Changer Operation

POSITION	REVERSING SWITCH CONNECTS R TO	SELECTOR SWITCHES CONNECT	
		R1 TO	R4 TO
8	8	4	4
7	8	4	5
L 6	8	5	5
O 5	8	5	6
W 4	8	6	6
E 3	8	6	7
R 2	8	7	7
I	8	7	TC2
N	3	TC2	TC2
I	3	TC2	4
R 2	3	4	4
A 3	3	4	5
I 4	3	5	5
S 5	3	5	6
E 6	3	6	6
7	3	6	7
8	3	7	7

CONTROL OPERATION

Exact details of control may vary slightly for different special units as shown by the wiring diagrams supplied with the particular equipment but in general the control functions are as follows: The control selector switch has five positions reading from left to right: LOWER, OFF, AUTO, OFF, and RAISE. For manual control in the lower direction placing the control selector switch on LOWER closes the AMCL contact and energizes the AL relay, which closes contact AL energizing the L contactor which closes the L contact and operates the tap changer in the lower direction. Placing the control selector switch on RAISE closes the AMCR and operates AR which closes contact AR energizing the R contactor which operates the tap changer in the raise direction.

For automatic operation the control selector switch is turned to AUTO. This closes the AMCA connecting the

circuit so that the CVR Voltage Regulating Relay contacts PL and PR initiate the changer operation.

If the voltage falls below the PR (left hand) contact setting long enough for the disk operated PR contact to close, the auxiliary relay AR is energized and seals itself in through the normally closed 120Y relay contact. Closing the AR relay energizes the R contactor which closes the R contact, starting the motor and causing the tap changer contacts to move to raise the voltage. Before the tap changer arcing contact has opened, the 120 cam-operated pilot switch closes to energize the 120X relay which takes over the sealing of the AR relay and operates the 120Y slug delay relay. The normally open 120Y relay contact closes and shorts the reactor with a 3000 ohm resistor to cause the disk to rotate and open contact PR so that there is only one tap changer operation at a time. After the tap changer arcing contact has closed on the next position the 120 pilot switch

opens allowing the 120X relay to de-energize the AR relay. The tap changer motor is then stopped by the spring loaded brake cam. If the voltage change is not adequate to correct the error the tap changer sequence is repeated after short time delays until the voltage is corrected or a tap changer limit is reached. If the voltage rises until the right hand PL contact closes, a similar sequence operates to lower the voltage.

When the control is de-energized, the CVR Relay Contact PR is closed. Therefore, immediately upon energizing the circuit, the AR Relay energizes and initiates the operation of the tap changer one position in the raise direction.

POSITION INDICATOR

Auxiliary limit switches built into the position indicator provide "Load Range Selection".

Detents are provided to insure that the range limit selected will coincide with a tap changer position. When the operator wishes to take advantage of the increased current rating provided by Load Range Selection the tap changer should be run to a position within the desired operating range. Otherwise, the new limits will not become effective until the tap changer does get into the new operating range.

For example, if the tap changer were on position 6 RAISE, and the new limits were changed to position 4R (5% raise), the tap changer would not move upward from position 6, but it would run toward neutral when called upon to do so. After moving downward to position 4R, the limit would become effective and the tap changer would not raise above position 4R. Thus it is desirable to run the tap changer to within the limits selected when some limit other than 10% has been selected.

Maintenance

INSPECTION

Type URF Voltage Regulators are designed for minimum maintenance. The first inspection should be made before the end of the one year warranty period so that any faults found can be corrected within the warranty. The second inspection should be made at the end of the next ten years or 400,000 operations, whichever comes sooner.

The relays should be checked for proper operation and for tight connections.

Maintenance of the selector switch contacts will depend upon the load which the regulator is called upon to carry and the frequency of tap changer operations. The arcing tips of the selector switch contacts are made of a special arc resisting alloy

to insure long life. These contacts should be inspected at the time of periodic inspection and should be replaced when necessary.

Replacement should be made before the moving finger shoes have burned sufficiently to reduce the smooth flat contact width to less than 1/4 inch and before the stationary contacts burn into the base material to which the arcing tips are brazed.

The oil in the tap changer compartment should be replaced or reconditioned when it tests less than 26 KV in the standard test cup. Under no condition should the tap changer be operated if the oil drops below 22 KV. The oil level in both compartments should be checked at the time of the periodic inspection.

Whenever oil is drained from the tap changer for inspection or maintenance, it is preferable that new, clean, dry, and filtered oil be returned to the tap changer compartment. If for any reason it is found necessary to reuse the same oil which was drained from the tap changer, the following precautions must be taken.

1. Be sure the drums used for oil storage are absolutely clean and dry. Inspection of the drums will save much grief.
2. Be sure the oil is filtered before it is returned to the tap changer compartment to remove any carbon, metal particles, or water which might have been present or introduced in handling.
3. The oil should be free of carbon before it is considered satisfactory.
4. After filling the tap changer compartment with oil and before energizing the unit, test at least three representative samples in the standard test cup. The test value should be 26 KV or better.
5. The regulator should never be energized when the oil in the housing tests less than 22 KV in the standard test cup.

Instruction book I.B. 45-063-100 covers the testing of WEMCO® "C" and WEMCO® "CI" oils. The oil level in the main tank should be checked at the time of periodic inspection. A combination sampling and drain valve for the oil is provided at the bottom of the tank. A drain pipe for checking the oil in the tap changer is located to the left of the control cabinet.

The diagram of connections for control equipment is shown on the wiring diagram furnished with the apparatus and is referenced on the nameplate. The internal high voltage connections for the regulator and the tap changer are shown on the diagram nameplate.

The operating mechanism is entirely immersed in oil which protects it against rust and insures proper lubrication.

CVR RELAY MAINTENANCE

The proper adjustments to insure correct operation of this relay have been made at the factory and should not be disturbed after receipt by the customer (with the exception of bandwidth or time delay settings). Repair work can be most satisfactorily done at the factory. I.B. 47-431-7 covers the setting and adjustment of the voltage regulating relay.

Before opening the Flexitest switches, switch the "Control Breaker" on the panel to "OFF", set "Current Selector" to "Short" and set "Control Selector" to "OFF".

CORRECTION OF MINOR TROUBLES

The following procedure is suggested in case the motor fails to operate.

1. Check voltage on the voltage test terminals with a voltmeter. If there is no voltmeter handy, the CVR Voltage Regulating Relay may be read to indicate the magnitude of voltage. If the voltage is high, the right hand contact of the CVR will close and if the voltage is low the left hand contact of the CVR will close.

2. If the load center voltage is low and the tap changer is at its upper limit position, as determined by the Load Range Selector Setting, the source voltage may be so low that the range of regulation is inadequate to correct the output voltage level.

If the load center voltage is low and the regulator is not on its upper limit position, it is possible that the voltage is too low to operate the control. (The relays and the tap changer will operate with 80% on the regulator output terminals.) If the output is above this minimum, further systematic checks are required.

3. If either L or R motor control contactor is closed, check to see that all contacts on the relay are making contact and that voltage appears across the motor leads T3 to LL or LR on the schematic.

4. If there is voltage at the motor terminals but it does not start,

a. The motor may be open-circuited. Each half of the motor winding should have about 25 ohms resistance for motor style 228A939HO1.

b. The capacitor may be opened. The capacitor is 20 mfd., 440 volts, 60 cycles; in emergency cases a capacitor of at least this value may be substituted for the capacitor in the unit. The capacitor is located at the top of the tap changer immediately below the handhole cover.

c. There may be foreign material between the motor pinion and gear causing gears to bind.

5. If the voltage regulating relay is energized but does not respond to voltage changes, see I.B. 47-431-7 for more detailed information.

MAJOR OVERHAUL AND REPAIR

If periodic inspection has shown that arcing contacts should be replaced and such contacts have been obtained, the following procedure is recommended.

1. Put the regulator on Neutral position, disconnect it from the line and, if platform mounted, remove it from the platform. Remove the handhole cover on the cover of the regulator. Remove the oil from both the regulator and the tap changer compartments.

2. Disconnect the three bushing leads by removing the adapters and bushing caps and remove the cover.

3. Remove one of the cotter pins which keep the cover-clamp beam in position and remove the cover-clamp beam.

4. Disconnect the control connector from the tank wall.

5. Remove the bolts clamping the vertical uprights to the tank. Disconnect the flexible

shaft running from the tap changer to the position indicator. This may be done by loosening the connecting nut where the flexible shaft connects to the position indicator inside the tank.

6. Remove the tap changer sump drain plug on the outside of the tank to the left of the control cabinet. Remove tap changer sump drain pipe with a pair of pliers.

7. The complete core and coil assembly including the tap changer can now be lifted out of the tank. After removal from the tank, the coils should be kept dry and clean. See Figure 16.

8. Remove the lifting channels and the side panels from the tap changer to provide room enough to replace the arcing contacts. See Figure 17.

9. The control leads may be connected to the control cabinet and the tap changer may be operated by applying test voltage to the test terminals. Be sure to open the control breakers before applying external voltage.

10. Reassembly should be carried on in reverse of the process outlined above. Be sure that the position indicator points to the position corresponding to the actual location of the tap changer when the unit is reassembled. The moving selector switch contacts are horizontal, pointing toward each other, when on neutral position.

11. If the same oil is to be put back into the regulator and tap changer, it should be filtered back. If no filter is available, clean oil should be put into the tap changer compartment and regulator tank. It is always advisable to check the dielectric strength of oil which is put into a regulator or transformer before energizing the unit.

12. When re-assembling the cover assembly to the unit, it is recommended that the cover bolt be pulled down snug. The bushing caps should then be assembled to the bushings. As a final step, tighten the cover bolt to a torque of 60 lb.-ft.

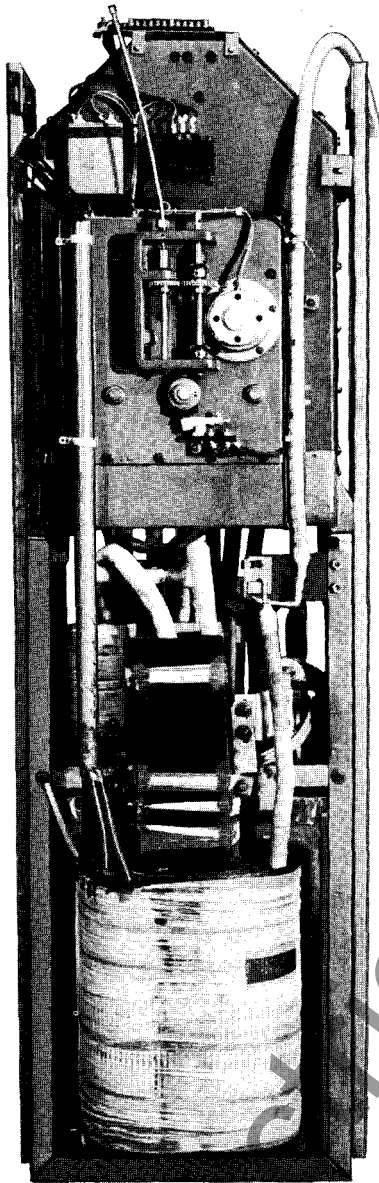

Fig. 16 - URF Internal Assembly
Removed from Tank

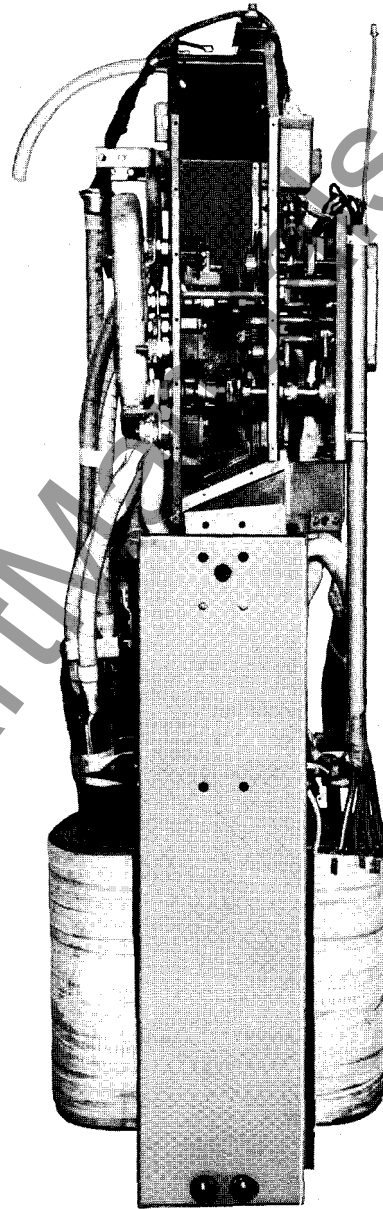

Fig. 17 - URF Internal Assembly
With Tap Changer Side Panel Removed

TEST AFTER OVERHAUL AND REPAIR

1. Apply 120 volts to the auto transformer in the motor circuit and run the tap changer thru its entire range and return. Be sure there is no binding and that the moving contacts change position rapidly. Open the control circuit breaker before applying voltage to the unit.

2. After tanking, the tap changer and control should be tested by energizing the control as per page 11. The Load Range Selector limit switches should be checked on every position to insure that the tap changer will be limited by the switch. The Load Range Selector limit switches are in series with limit switches that are part of the tap changer. The tap changer switches

operate on positions 8R and 8L, and, in effect, back up the operation of the LRS limit switches. When on a limit position, the motor should not be energized by the Manual Control or CVR Relay. If the motor does become energized, it indicates that the position indicator was not on position when connected to the tap changer by the flexible shaft or that the limit switches have been somehow rendered inoperative.

SPARE PARTS

The customer will find that a minimum of spare parts will be required for the URF Regulator. If so desired, a set of stationary and moving arcing contacts for the load tap changer may be kept in stock. It might be desirable to stock one set of cover gaskets, one bushing and one lightning arrester. A CVR Voltage Regulating Relay and Flexitest plug S#1164046 may be purchased and will permit complete replacement of the relay in less than a minute. The plug permits complete testing of the relay on the test bench with convenient slip connections.

The following list of items and corresponding Westinghouse style numbers is provided for ease of identification should the need arise for ordering spare parts.

Parts common to all URF Regulators:

Tap changer motor assembly S#231A320G01

Motor capacitor S#1446014
 Selector finger assembly (moving contact) S#322B004GR1 Req. 2
 Terminal TC2 stationary contact S#228A943G01 Req. 1
 Stationary contact S#228A004G01 Req. 8
 CVR Voltage Regulating Relay S#1961157
 Position indicator S#592D535G02
 Position indicator gaskets S#231A694H01
 Position indicator, glass and bezel kit S#455C606G01
 Hand hole cover gaskets S#242A997H01
 Cover gasket S#247A453H01

Parts not common for all ratings:

VOLTS	STYLE NUMBER	
	Bushing	Valve Type Arrester
2,500	592D544 Group 4	1743285
5,000	592D544 Group 4	1743286
7,620	592D544 Group 5	1743287
13,800	592D544 Group 5	1743289

SUPPLEMENTARY DATA

Supplementary data consists of the following Instruction Booklet I.B. 47-431-7.

WWW.ElectricalParts.com

MEMORANDUM

www.ElectricalPartManuals.com

www.ElectricalPartManuals.com

**Instructions for
Type URL Step Voltage Regulator**



Westinghouse Electric Corporation

Sharon Plant, Transformer Divisions, Sharon, Pa.

I. B. 47-060-58 Effective June, 1962 Supersedes I. B. 47-435-2, May, 1958

Table of Contents

GENERAL INFORMATION	Page
Application	5
Operating Limits	5
Voltage and Current Limits	5
Definition of Nameplate Values	5
Operating Ambient Temperature	5
Installation Altitude	5
Surge Protection	6
Short Circuit Rating	6
Potential Transformer Ratios	6
Current Transformers	6
Overload Capacity	7
 DESCRIPTION	
URL Regulator	7
Control Equipment	7
Load Tap Changer	8
Position Indicator and Load Range Selector	10
 INSTALLATION	
Receiving, Handling and Storing	10
Preparation for Installation	10
Checking Operation of Control	11
Reduced Capacity Operation	12
Mounting, Connecting and Disconnecting the Regulator	12
Three Phase Operation	16
Mounting Control Remotely	16
 SETTING AND ADJUSTMENTS	
General	17
Position Indicator	17
Load Range Selection	17
Control Panel Adjustments	17
 OPERATION	
Load Tap Changer	20
Control Operation	21
Position Indicator	22
 MAINTENANCE	
Inspection	22
CVR Relay Maintenance	23
Correction of Minor Troubles	23
Major Overhaul and Repair	24
Test After Overhaul and Repair	25
Spare Parts	26

SUPPLEMENTARY DATA

I.B. 47-431-7 - Voltage Regulating Relay, Type CVR



List of Illustrations

Figure	Page
1 External View of URL Regulator	5
2 Regulator Control Panel with Cover Removed from CVR Relay	7
3 URL Tap Changer with Side Panels Removed	8
4 Schematic of Geneva Gear Drive	9
5 ValvEx® Type Arrester Air Gap Adjustments	11
6 Typical Nameplate for URL Regulator	13
7 Typical Installation of URL Regulator	14
8 Single Phase Connections	14
9 Two Units, Open Delta Connected	15
10 Three Units, Delta Connected	15
11 Three Units, Wye Connected	15
12 Disconnecting Flexible Cable from Regulator Tank	16
13 Remote Mounted Control Cabinet	16
14 Position Indicator with Load Range Selector	17
15 Schematic Diagram of Typical URL Regulator	18
16 Typical Adjustment and Control Switches	19
17 URL Internal Assembly	23
18 Removing Stationary Contact from URL Tap Changer	24
19 Removing Moving Contact from URL Tap Changer	25

LIST OF TABLES

Table	
I Preferred Voltage Ratings for Regulators	6
II Lightning Arrester Gap Settings	7
III Load Range Selection	17
IV Sequence of URL Tap Changer Operation	20

This instruction book has been prepared to assist the purchaser to properly install, operate and maintain the type URL Step Voltage Regulator supplied by Westinghouse. The information presented is based on the best practical judgement of Westinghouse engineers gained from design and installation of this apparatus and from reported experience of users of similar equipment.

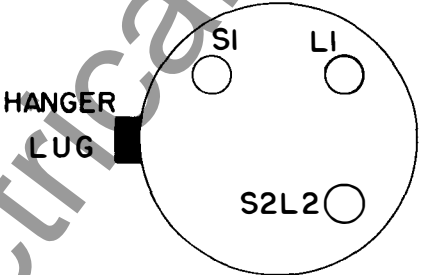
 <h1 style="margin: 0;">Westinghouse</h1> 		
KVA—CONTINUOUS 55°C. RISE	<h2 style="margin: 0;">URL</h2> <h2 style="margin: 0;">VOLTAGE REGULATOR</h2>	INSTALL AND OPERATE AS PER INSTRUCTION BOOK 47-060-58
STYLE	SINGLE PHASE 60 CYCLES ○	SEE INSTRUCTION PLATE INSIDE CONTROL CABINET FOR ADDITIONAL INFORMATION
VOLTAGE	BUSHING LOCATION 	CAUTION: OPERATE TO NEUTRAL AND OPEN CONTROL BREAKER BEFORE BY-PASSING
AMPERES		
SERIAL NUMBER IS STAMPED IN TANK METAL BELOW THIS PLATE		
149P807HOI-A	WESTINGHOUSE ELECTRIC CORPORATION	MADE IN U. S. A.

The information appearing on the nameplate of your particular regulator may be copied in the blanks above for your convenient future reference.

Read this book before installing and operating your regulator.

General Information

APPLICATION

Westinghouse distribution type feeder voltage regulators are designed to maintain proper load center voltage by automatically correcting for changes in supply voltage and for voltage drop from the regulator to the load center. Westinghouse distribution regulators are completely automatic and self-contained.

Westinghouse URL distribution regulators are available in 2500, 5000, 7620, 13800 and 14400 volt ratings.

OPERATING LIMITS

1. Voltage and Current Limits. Standard Westinghouse distribution voltage regulators are built in line with current, applicable ASA, AIEE, NEMA and EEI-NEMA standards.

The regulators are designed to operate at rated current over a voltage range as specified in Table 1. (See Table I, page 6.)

A regulator is a current rated device and this rating must not be exceeded on a continuous basis regardless of voltage.

Example, a 5000 volt, 100 ampere, 50 KVA regulator may be operated at 2500 volts at 100 amps and 25 KVA.

2. Definition of Nameplate Values.

(a) Rated voltage is the input voltage on which performance characteristics are based.

(b) Rated current is the allowable continuous load current at rated voltage and $\pm 10\%$ regulation.

(c) Rated KVA is rated voltage x rated current x .10/1000.

(d) Impedance - % impedance shown on nameplate is based on a line KVA of 10 x rated regulator KVA, and on regulator rated voltage and current.

3. Operating Ambient Temperature. Ambient Temperature should not exceed 40°C (104°F) nor exceed an average of 30°C (86°F) in a 24 hour period.

4. Installation Altitude. The regulator may be operated at full KVA at elevations

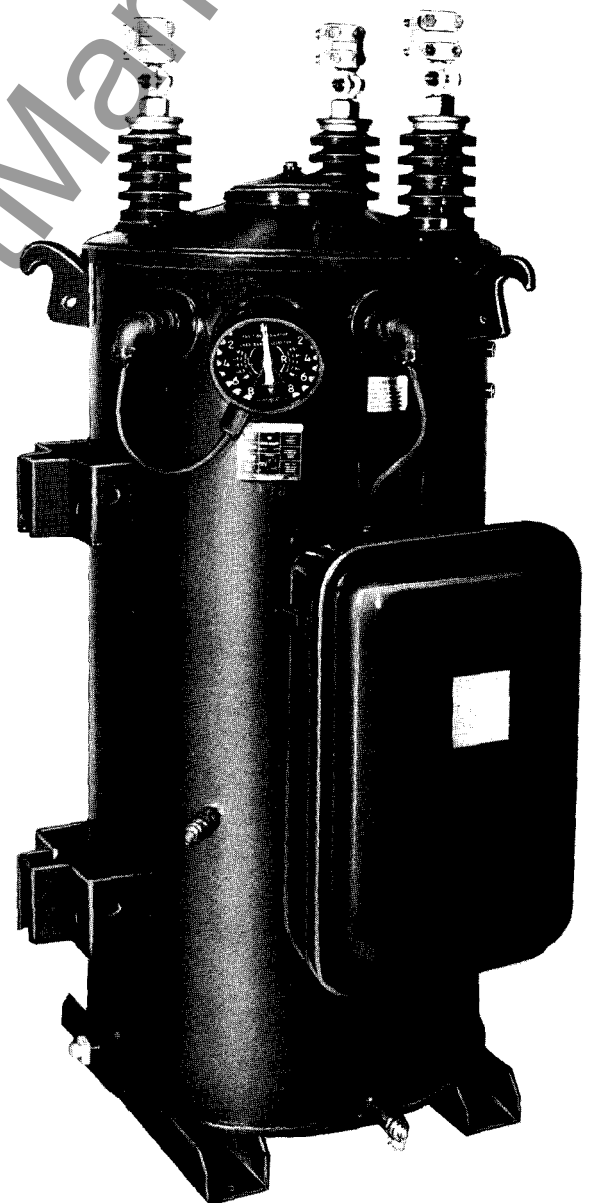

Fig. 1 - External View of URL Regulator

up to 3300 feet (1000 meters). When used at higher altitudes than 3300 feet the KVA must be reduced as specified in ASA Standards.

5. Surge Protection. Standard regulators, except 14,400 volt units are available either with or without arresters. When a regulator is purchased with ValvEx® arresters, no additional surge protection is required. When a regulator is purchased without arresters, suitable protection must be provided at the time of installation.

The most reliable method of regulator protection is by means of an arrester between the S-1 terminal and ground plus a second arrester between the L-1 terminal and ground. An alternate method of protection is by means of a by-pass arrester connected between the S-1 and L-1 terminal plus a second arrester connected between either the S-1 or L-1 terminal and ground.

In addition to the above arresters a third arrester must be connected from S2L2 to ground unless this terminal has been solidly grounded.

Table II lists the proper arrester gap settings. The correct gap dimension will also be found etched in the porcelain near the bottom of the arrester.

The tank should be solidly grounded. The control cabinet should also be solidly grounded whenever it is mounted separately from the regulator tank.

6. Short Circuit Ratings. URL regulators will withstand a short circuit of 25 x rated current for 2 seconds or 40 x rated current for 0.8 second. Where system fault currents would exceed these values, use of current limiting reactors is recommended.

7. Potential Transformer Ratios. The auxiliary windings have the potential ratios indicated on the regulator nameplate. All auxiliary windings have sufficient capacity for a recording voltmeter. The nameplate in the Regulator Control Cabinet should be checked for the ratio of a particular unit.

8. Current Transformers. All URL Regulators are provided with a tapped current transformer having a secondary current

TABLE I
Preferred Voltage Ratings for Regulators

NOMINAL SYSTEM VOLTAGE	REGULATOR VOLTAGE RATING VOLTS	OPERATING VOLTAGE LIMITS*				
		Input Voltage - Volts			Output Voltage - Volts	
		Single Phase	Minimum	Maximum At Rated Load Amperes	Maximum At No Load	Minimum
2400	2500	2125	2625	2750	2250	2750
2400/4160Y	2500	2125	2625	2750	2250	2750
4800	5000	4250	5250	5500	4500	5500
7200	7620	6290	8000	8380	6860	8760
4800/8320Y	5000	4250	5250	5500	4500	5500
12000	12000	10200	13200	13720	10800	13720
7200/12470Y	7620	6290	8000	8380	6860	8760
7620/13200Y	7620	6290	8000	8380	6860	8760
13200	13800	11730	14500	15180	12400	15180
14400	13800	11730	14500	15180	12400	15180
14400/24940Y	14400	12240	15120	15840	12960	15840

* Includes all voltage tolerances

TABLE II
Lightning Arrester Gap Settings

ARRESTER KV RATING	ARRESTER GAP SETTING	REGULATOR VOLTAGE RATING
3	1/4"	2500
6	3/8"	5000
10	1/2"	7620
15	3/4"	13800

rating of 0.24 amperes with 60%, 100%, or 160% rated current.

This current transformer is designed to operate the regulator control with ASA Class I accuracy. The addition of the usual meter burden will not appreciably affect this operation, and this current supply may, therefore, be used to operate a thermal

ampere demand indicating or recording ammeter for load checking. It is not intended, however, that this current transformer be used for metering.

The 60 percent ratio is to permit full load compensation at 60 percent of rated current and the 160 percent ratio for the higher currents associated with Load Range Selector operation of the regulator.

Selection of the proper current transformer ratio is made by use of the Current Selector switch on the control panel. A tabulation on the instruction nameplate indicates the proper ratio to be used for a given operating condition.

9. Overload Capacity. URL Regulators may be overloaded in accordance with ASA Guides C57.95.

Description

The URL Regulator provides voltage regulation of 10% above and below incoming or source voltage in sixteen 1-1/4% steps. The regulator is complete including oil and is ready for installation. Devices mounted on the tank include the position indicator, the control cabinet, hanger lugs, and provision for sampling and draining the tap changer compartment and the main tank oil independently of each other.

The regulating transformer, preventive-auto, current transformer and load tap changer are mounted as an assembly in a common end frame and lowered into the tank as a complete unit. An auxiliary winding on the regulating transformer supplies control power and voltage.

CONTROL EQUIPMENT

Figure 2 shows the URL control equipment which is mounted on a hinged glass reinforced polyester panel housed in a weather-

proof control cabinet which in turn is mounted on the regulator. A plug type connector is used to connect the control



Fig. 2 - Regulator Control Panel with Cover Removed from CVR Relay

cabinet to the control components in the main tank making it easy to remove the control cabinet for remote mounting. Flexible control lead assemblies, complete with a plug-type connector are available for this purpose.

The only wiring required at the installation site is to cut the cable to the exact length desired, install terminals on the conductors and connect them to the block in the cabinet.

The URL Regulator control equipment is designed around the CVR Voltage Regulating

Relay. The CVR Relay is mounted in the regulator control cabinet. The major components of the CVR Relay are an induction disk type voltage sensing element, two pilot relays, two motor control relays, and a reactor. All components are in a drawout chassis so that the complete relay may be interchanged between units or removed for testing and inspection. The Flexitest switch base is made an integral part of the CVR Relay to facilitate connecting and testing the relay.

The case in which the CVR Relay is mounted for the URL Regulator control is equipped with the mating portion of the Flexitest switches.

For control function and detailed information see Settings and Adjustments, page 17.

LOAD TAP CHANGER

The controlled, shockless, fast action of the URL tap changer is obtained by use of a direct Geneva gear drive mechanism (see Figures 3 and 4).

Successive taps of the regulating winding are connected to stationary contacts arranged in two circles on a Micarta® insulating panel which forms the back wall of the tap changer.

A central contact in each circle is connected to one end of the preventive auto-transformer. The moving contact for each circle bridges from the center contact to the successive tap contacts as it is rotated by a shaft from the operating mechanism.

In changing taps, starting with both moving contacts connected to the same tap, one moving contact rotates to the next tap or stationary contact while the other moving contact remains stationary. In this position, the two ends of the preventive auto-transformer are connected to adjacent taps of the regulating transformer series winding. This is known as a bridging position. The preventive auto-transformer is designed to

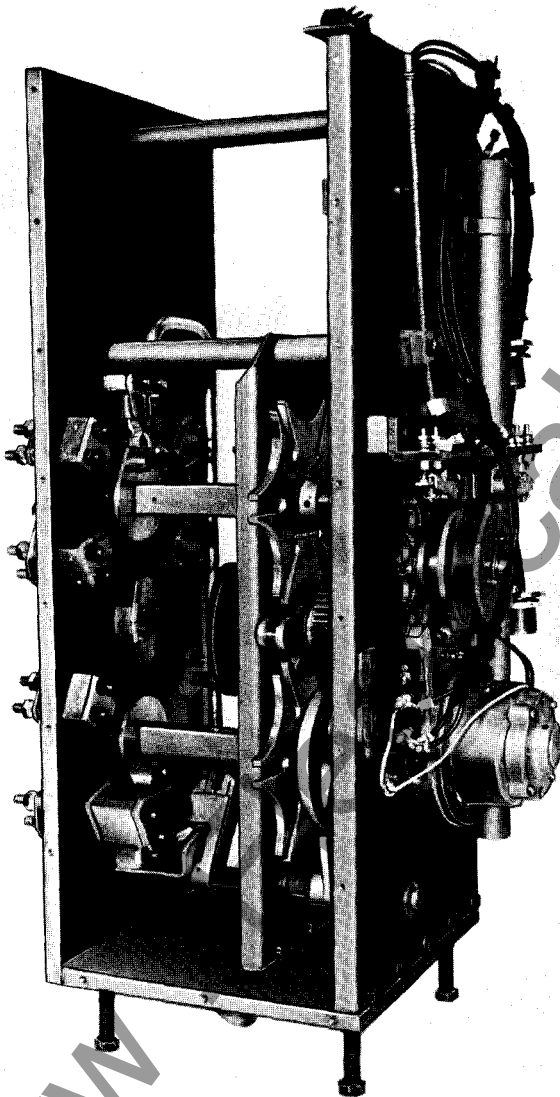

Fig. 3 - URL Tap Changer with Side Panels Removed

operate continuously in this manner. To make the second tap change, the other moving contact is moved to the next tap to short the preventive auto-transformer by connecting both ends to the same tap of the regulator series winding.

The selector switch stationary contacts are tipped with a special arc resisting alloy. The moving contacts are self aligning contacts made of sintered-tungsten alloy.

The mechanism is powered by a 1/30th horsepower capacitor type motor which is directly geared to a Geneva pinion. For a single tap change the Geneva pinion makes 1/2 revolution but the Geneva gear and tap changer contact moves only 1/6 revolution. Because the moving contact arm is locked in position during much of the movement of the Geneva pinion, it is not necessary that the motor and Geneva pinions stop on an exact position. They may drift within liberal limits without moving the tap changer contacts. A brake consisting of a spring-loaded arm riding on a figure eight-shaped cam insures that the Geneva pinion will stop within these limits.

In the URL tap changer, a reversing switch automatically connects the series winding of the regulating transformer to either raise or lower the output voltage. The reversing switch is a no-load switch which moves after the load current has been interrupted by the selector finger contacts.

The reversing switch as well as the selector switches are directly coupled to the driving mechanism through Geneva gearing. The operating sequence of the switches is shown in Table IV on page 20.

Figure 4 illustrates the operation of the Geneva Gears in the tap changer mechanism. It should be noted that the Geneva pinion is positively geared to the operating motor at all times. To make a tap change the following sequence of operation is followed:

Illustration 1. Prior to any movement, the two Geneva gears "E" and "F" are locked into position at points "B" by pinion "A".

This means that the contacts cannot move except when an actual tap change is in progress.

Illustration 2. Pinion "A" has made one-quarter revolution and pin "C" has entered slot "D" and has caused Geneva gear "E" to rotate 30 degrees from position shown in (1), bringing the moving contact to a point half way between the stationary contacts.

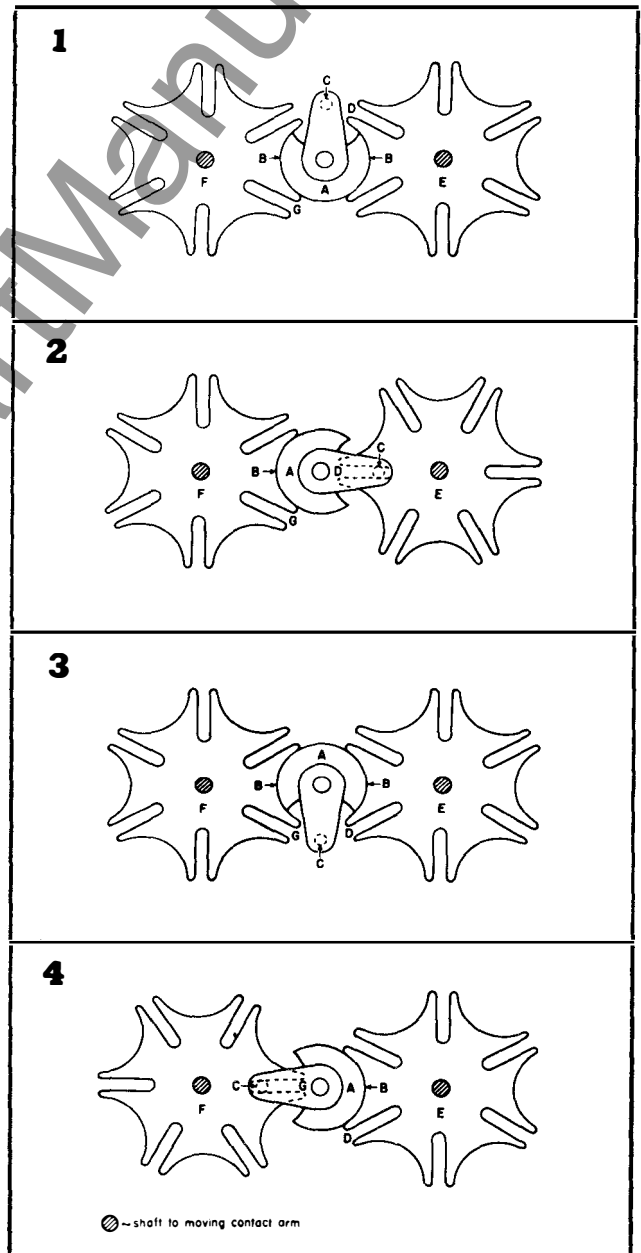

Fig. 4 - Schematic of Geneva Gear Drive

Illustration 3. Pinion "A" has completed one-half revolution. Slot "D" has rotated 60 degrees from position shown in (1) and is locked onto the next stationary contact. This constitutes one complete tap change or a 1-1/4% step.

Illustration 4. Pinion "C" has entered slot "G" on Geneva gear "F" and will cause another tap change to be made similar to that described in (2) and (3). When pinion "A" returns to the position shown in (1), it will have changed the voltage 2-1/2% in two 1-1/4% steps.

Additional steps in the same or reverse direction are made in a similar manner. Cam operated limit switches prevent the tap changer from going beyond the limits in either direction. Another switch operated by a cam on the Geneva pinion shaft works in conjunction with the control relays to start the motor and stop it when the contact arms are on position.

The tap changer is enclosed to prevent the free interchange of tap changer oil with

regulator oil. A sump at the bottom of the tap changer collects sediment and permits complete drainage of the tap changer compartment through a drain pipe which extends through the outside wall of the regulator.

POSITION INDICATOR AND LOAD RANGE SELECTOR

The URL Regulator is equipped with a position indicator which shows the tap changer position at any time.

Resettable maximum-minimum indicating hands show the range over which the tap changer has operated since they were last reset.

"Load Range Selector" limit switches are incorporated into the position indicator. These limit switches may be set by means of knobs outside the indicator housing to limit the range of regulation to 5, 6-1/4, 7-1/2, 8-3/4, or 10% raise or lower. Separate settings are provided for raise and lower limits.

Installation

RECEIVING, HANDLING AND STORING

URL Step Voltage Regulators are shipped completely assembled. Immediately on receipt, shipments should be checked for possible damage or shortages. Any shortages or damage should be reported to the transportation company.

The URL Regulators may be lifted by means of lifting lugs welded to the tanks.

These regulators are built for outdoor service, therefore, no unusual storage precautions are necessary. It is preferable to store them in locations where the humidity is not extremely high.

PREPARATION FOR INSTALLATION

The URL Step Voltage Regulator has been carefully inspected and tested at the factory before shipment; however, it should be inspected prior to installation, observing the following items:

1. Test a sample of the oil from the regulator in a standard oil test cup. Oil suitable for use in a regulator should test at least 26 KV. In no case should a transformer or regulator be energized when the oil tests less than 22 KV. If moisture is indicated, the oil should be removed and filtered and the unit should be dried. Oil removed from the regulator should be replaced with clean dry oil. Before energizing the regulator check to insure that the oil level is up to the cold oil level stenciled on the inside of the tank wall.

2. If lightning arresters are furnished the air gap should be set at the spacing stenciled on the arrester porcelain. See Table II for gap settings when mounting the arrestors on the tank. Adjustments are provided in both the vertical and horizontal directions. See Figure 5.

3. The URL Regulator is shipped with the tap changer on neutral position. The internal connections for various tap changer positions are shown on the nameplate located in the control cabinet. Figure 6 shows a typical nameplate.

4. Before operating, the blocking should be removed from the type CVR Voltage Regulating Relay.

Make sure that all parts of the CVR Relay operate freely and inspect the contacts to see that they are clean and close properly.

CHECKING OPERATION OF CONTROL

Electrical tests can be made by applying a variable voltage source to the test terminals of the control panel.

NOTE: Be sure the control circuit breaker is in the off position and the link G to TT2 is disconnected before applying test voltage. Otherwise the regulator may be energized thru the potential circuit producing high voltages. Use not more than 10 ampere fuses in the supply circuit.

The following sequence of tests is recommended.

A. Apply 120 volts (or the voltage at which the voltage regulating relay is balanced) to the test terminals and then place the control selector switch on the RAISE or LOWER position. The tap changer will run to the raise or lower limit without pause depending on whether the control switch is left on the RAISE or LOWER position. Return tap changer to neutral position.

B. Place the control selector switch on AUTO and reduce the voltage two volts below the balance voltage. After a time delay the CVR Relay contacts will close and the tap changer will operate in the raise direction with a short pause between steps until the limit position is reached.

NOTE: Bear in mind that the relay is not regulating the external voltage; therefore, the voltage on the CVR Relay is unchanged and the tap changer will operate until a limit position is reached.

C. Now raise the voltage to two volts above the balance voltage and a similar sequence of operations will take place in the lower direction.

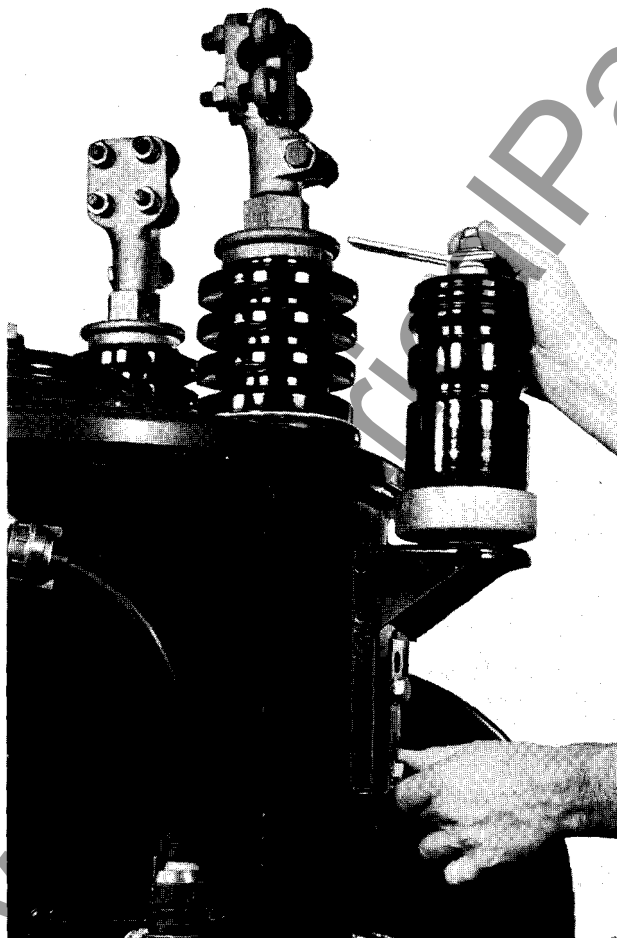

Fig. 5 - ValvEx® Type Arrester
Air Gap Adjustments

REDUCED CAPACITY OPERATION

All standard 5000, 7620 and 13,800 volt URL Regulators are provided with taps in the auxiliary winding for operating the regulator at reduced voltage. When operated at reduced voltage the current rating of the regulator must not be exceeded. The correct control voltage is selected by means of a Faston tab on the terminal block under the handhole cover. Refer to the wiring diagram and regulator nameplate for proper control connections. The exact control voltage ratios are indicated on the regulator nameplate inside the control cabinet. See Figure 6 for a typical nameplate.

For a typical 2500 volt regulator lead X1 would be connected to terminal 16 (lead TA) on the terminal block for the ratio of 2500 to 125.

In a typical 5000 volt regulator (which has additional taps in the regulator auxiliary winding), for 5000 volt operation connect lead X1 to terminal 14 (lead TC). For 4330 volt operation connect lead X1 to terminal 15 (lead TB). For 2500 volt operation connect lead X1 to terminal 16 (lead TA) on the terminal block.

In the typical 7620 volt regulator lead X1 is connected to terminal 13 (lead TD) for use on a 7960 volt line. Lead X1 is connected to terminal 14 (lead TC) for use on a 7620, 7200 or 6900 volt line. Lead X1 is connected to terminal 15 (lead TB) for use on a 5000 volt line and lead X1 is connected to terminal 16 (lead TA) for a 2500 volt line.

In the typical 13,800 volt regulator lead X1 is connected to terminal 13 (lead TD) on the terminal block for 14,400, 13,800, and 13,200 volt operation. However, for 12,000 volt operation lead X1 is connected to terminal 14 (lead TC) on the terminal block. Lead X1 is connected to terminal 15 (lead TB) for use on a 7960 line. Lead X1 is connected to terminal 16 (lead TA) for use on a 7620, 7200 or 6900 volt line.

The control voltage is not the same for all these connections. This must be con-

sidered in setting the balance voltage of the CVR Relay.

NOTE: The operator should always use the nameplate information to make these connections rather than to use the typical connection cited in the instruction book.

MOUNTING, CONNECTING AND DISCONNECTING THE REGULATOR

The URL Regulator is suitable for either direct pole or platform mounting. The tank has provisions for bolting down when platform mounted. Figure 7 shows a typical installation of a pole mounted regulator.

For operating convenience combination disconnecting and by-passing switches or at least three disconnect switches should be used for connecting, disconnecting and by-passing the regulator. This facilitates installing and servicing the regulator without taking the line out of service. In general it is desirable to use a fourth disconnect between S2L2 and the common line, or neutral, so that the unit may be completely isolated from the lines when being serviced.

In some cases the S2L2 disconnect may not be required. This must be determined by system rules and by the conditions of grounding on the system.

CAUTION: When connecting a regulator to the line it is extremely important that the regulator be operated to **NEUTRAL** position. If this is not done there is danger of a short circuit on the series winding of the regulator. The following procedure should be followed when connecting the regulator to a line without removing the line from service.

1. Operate the Quicklag[®] breaker on the control panel to the open position and the Control Selector Switch to the OFF position.
2. The neutral disconnect should be closed or a solid connection made to the system neutral.
3. Close the source disconnect switch. The regulator is now energized.

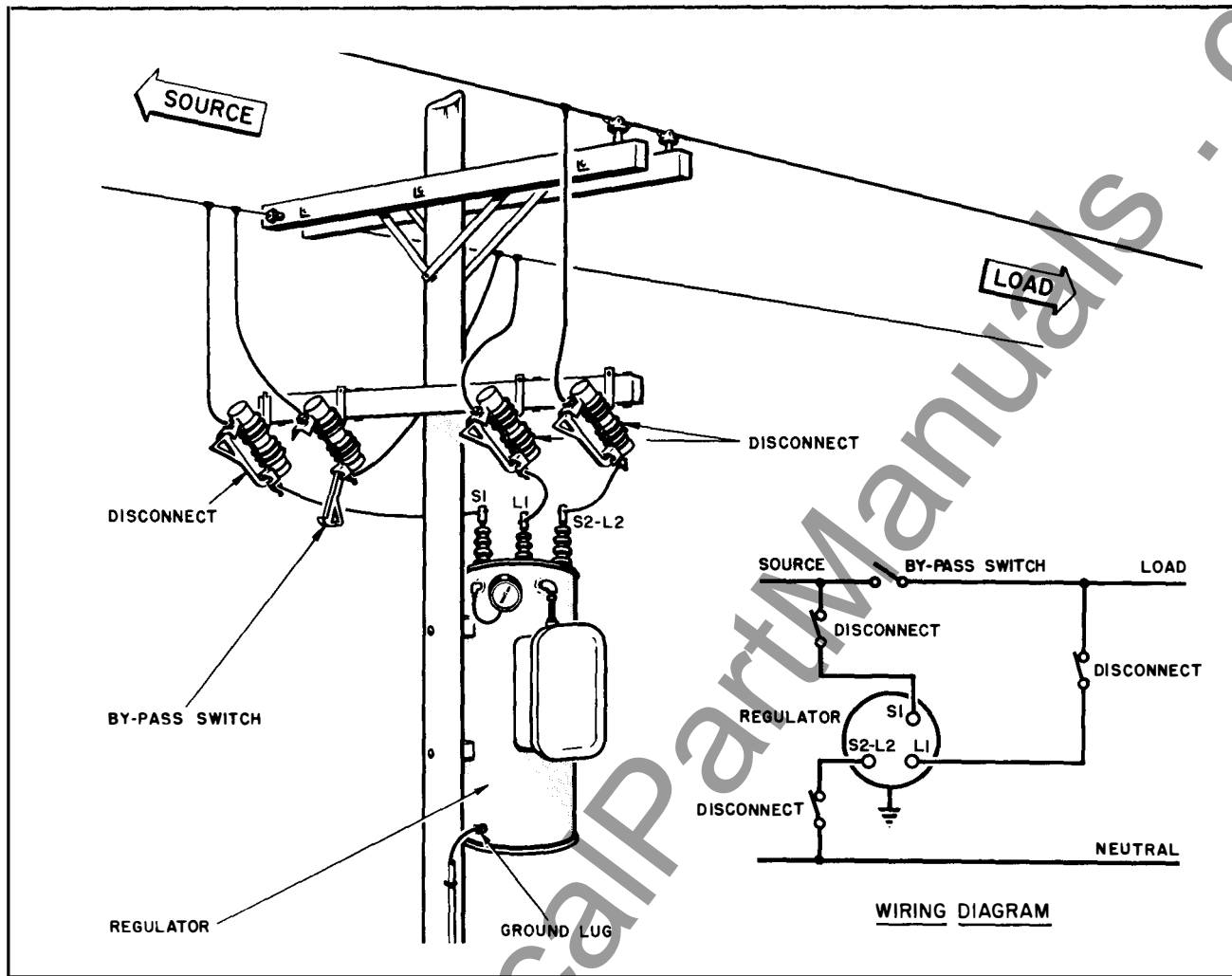

Fig. 7 - Typical Installation of URL Regulator

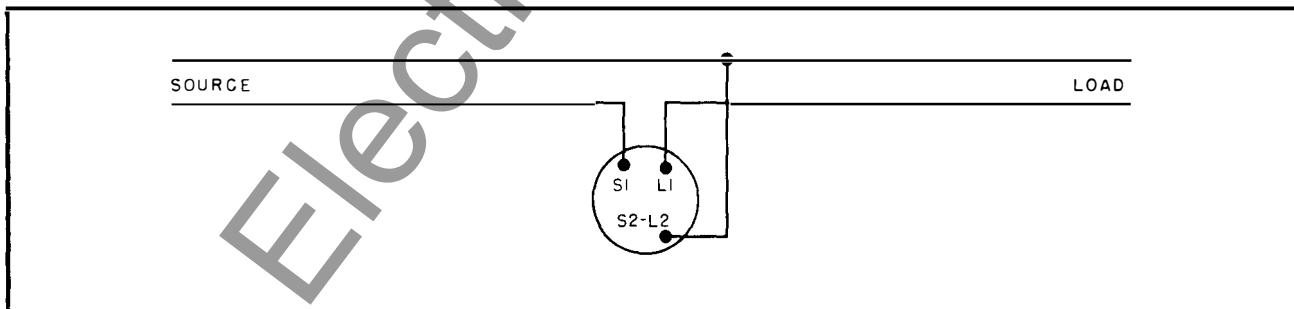

Fig. 8 - Single Phase Connections

4. At this point the control panel and voltage regulating relay settings should be made, following settings and adjustments. See IB 47-431-7.

This can be done either by using a separate voltage source or by using the control voltage obtained from the energized regulator.

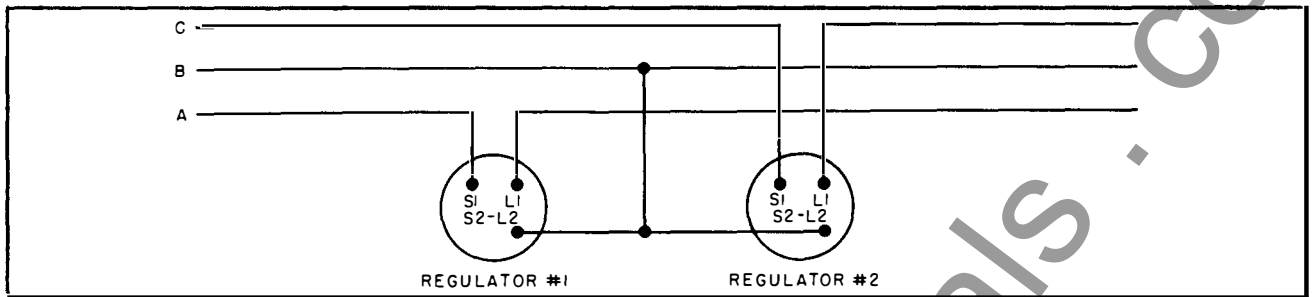

Fig. 9 - Two Units, Open Delta Connected on a Three Phase, Three Wire Circuit - Phase Sequence ABC

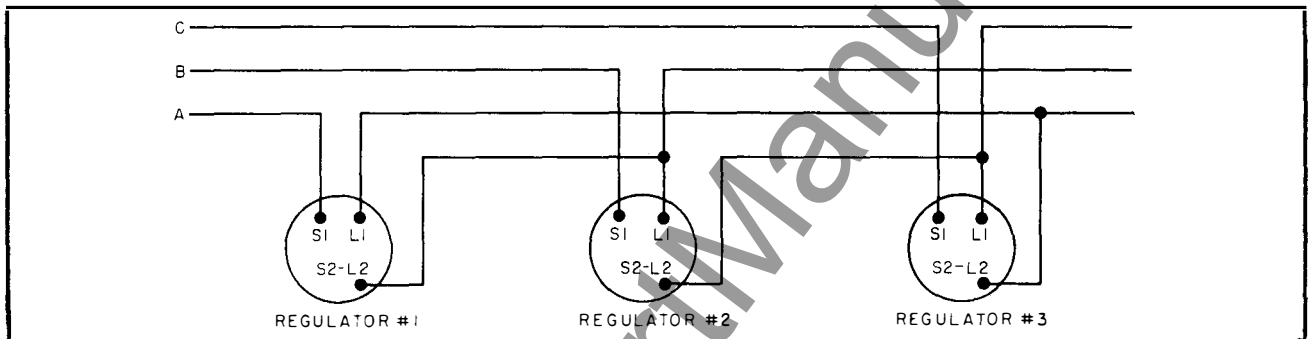

Fig. 10 - Three Units, Delta Connected, on a Three Phase, Three Wire Circuit - Phase Sequence ABC

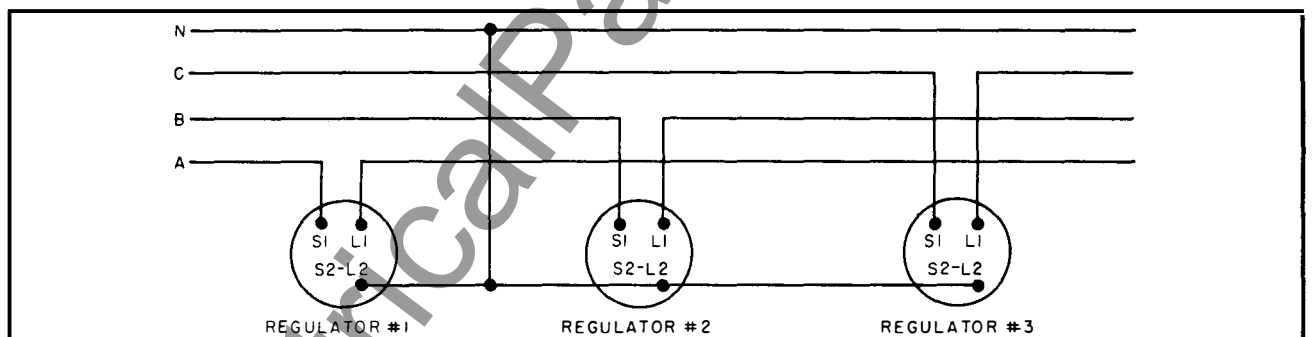

Fig. 11 - Three Units, Wye Connected, on a Three Phase, Four Wire Circuit - Phase Sequence ABC

5. After completing step 4, operate the load tap changer to the neutral or by-pass position. Open the Quicklag[®] breaker if it was closed in step 4 above.
6. Close the load disconnect switch.
7. Open the by-pass switch.
8. With the adjustments and settings made, the Quicklag[®] breaker may be closed and the control switch set for automatic operation. The URL Regulator will now operate to maintain load center voltage at the desired level.

The following procedure permits disconnecting the regulator without interrupting load:

1. Operate the tap changer to neutral position by means of the Control Selector Switch.
2. Open the Quicklag[®] breaker to de-energize the control circuit.
3. Close the by-pass switch.
4. Open the load disconnect switch.
5. Open the source disconnect switch. The neutral may now be disconnected. Where a combination by-pass and disconnect switch is used, the regulator must be on neutral position before this switch is operated.

THREE PHASE OPERATION

For 3-phase, 3-wire circuits, two single phase units may be used in open delta, or three single phase units may be connected in closed delta. When three regulators are connected in a closed delta bank, the bank will provide approximately plus or minus fifteen percent range of regulation with an accompanying phase shift. The bank current capacity is the same as the single phase current rating.

Single phase URL Regulators are insulated for operation in banks of three units connected in wye on 3-phase, 4-wire circuits, provided the neutral of the regulator bank is connected to the system neutral, regardless of whether or not the system neutral is grounded. If the system neutral is not available the URL Regulators must not be connected in wye. When connected for 3-phase operation each regulator operates independently from the other regulators in the bank and may be treated as a single phase unit. The directions for by-passing are the same as for single units. These connections are illustrated in Figures 9, 10 and 11.

MOUNTING CONTROL REMOTELY

It is sometimes desirable to locate the control cabinet remotely for convenience in servicing and inspecting the control. To do this proceed as follows:

1. Operate regulator to Neutral and open the Quicklag breaker.
2. By-pass the regulator.
3. Disconnect the flexible lead from the tank and from the control cabinet.

CAUTION: The control cable contains current transformer leads which must not be disconnected while the unit is carrying a load.

4. Remove the control cabinet from the regulator tank.
5. Mount the control cabinet to the pole in the selected location and solidly ground it.
6. Plug an appropriate length cable into the tank connector, connect lower end to control



Fig. 12 - Disconnecting Flexible Cable from Regulator Tank

cabinet terminal block and tighten cable clamp.

Connector cables may be purchased from the Renewal Parts Section, Sharon Plant where they are stock items in 5 ft. increments of length.

7. Re-energize the regulator.
8. Place the Control Selector on "AUTO".

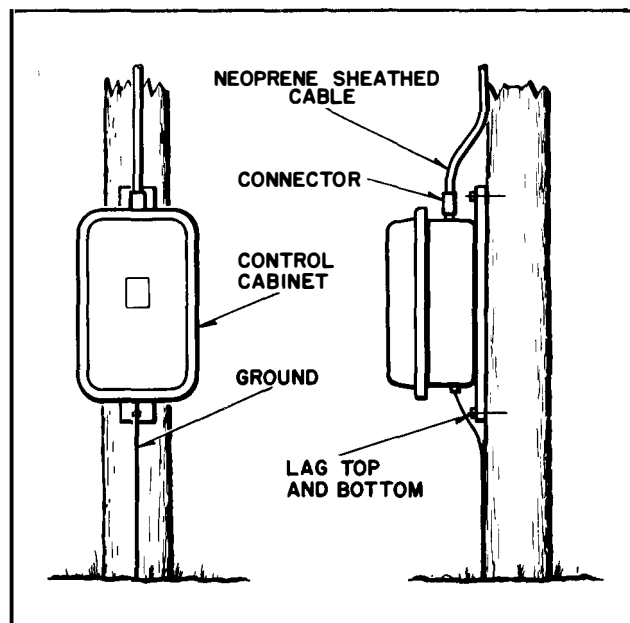

Fig. 13 - Remote Mounted Control Cabinet

Settings and Adjustments

GENERAL

All settings and adjustments to be made on the URL Regulator are on the control panel except for the Load Range Selector Settings on the position indicator. The settings that can be made are voltage level, bandwidth, time delay, reactance and resistance line drop compensation, line drop compensator polarity, and current transformer ratio. Voltage level, band width and time delay setting and/or adjustments are made within the voltage regulating relay itself. Reactance and resistance line drop compensation, current transformer ratio selection and line drop compensator polarity settings are made by use of rheostats or tap switches, mounted on the control panel. See IB 47-431-7.

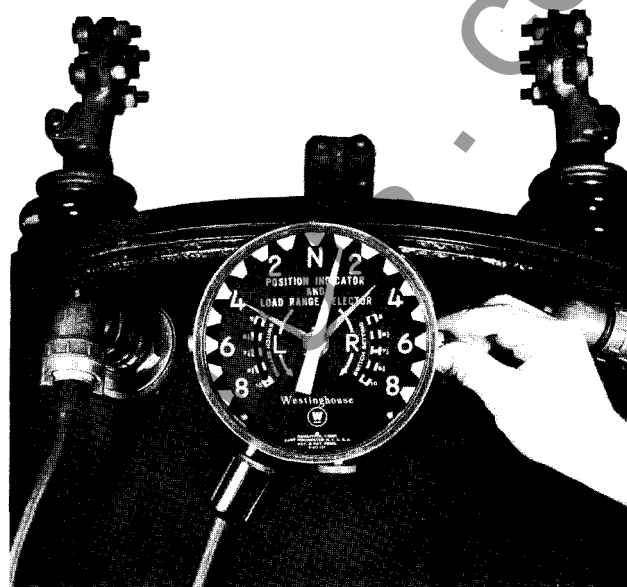

Fig. 14 - Position Indicator with Load Range Selector

POSITION INDICATOR

The URL position indicator shows the position of the tap changer. A pair of red maximum and minimum position indicating hands shows the maximum range over which the tap changer has operated since the indicator was last reset.

These maximum-minimum indicating hands are reset by depressing a large spring loaded plunger in the bottom of the position indicator. A hot stick or suitable pole may be used to depress the reset plunger from the ground on pole or platform mounted regulators. (For current rating data refer to Table III.)

LOAD RANGE SELECTION

Load Range Selection limit switches are built into the position indicator. They may be set to limit the range of regulation to values other than plus or minus 10%. The raise and lower ranges are independently adjustable by means of knobs at the sides of the position indicator assembly. To change the range of regulation depress the knob and

turn it. The new range of regulation will be shown by indicators which may be seen through calibrated slots in the indicator dial.

When Load Range Selection Operation is to be set up, a current transformer ratio is to be selected by use of the Current Selector switch on the control panel. See Instruction Plate for ratio to be used.

TABLE III
Load Range Selection

POSITION INDICATOR LIMIT SWITCH SETTING	% RATED LINE AMPERES*	OPERATION RANGE - POSITIONS
10%	100	8R to 8L
8-3/4%	110	7R to 7L
7-1/2%	120	6R to 6L
6-1/4%	135	5R to 5L
5%	160	4R to 4L

* This current limit must not exceed 400 amperes.

CONTROL PANEL ADJUSTMENTS

The Test Voltage Rheostat Control is a combination motor circuit interlock switch

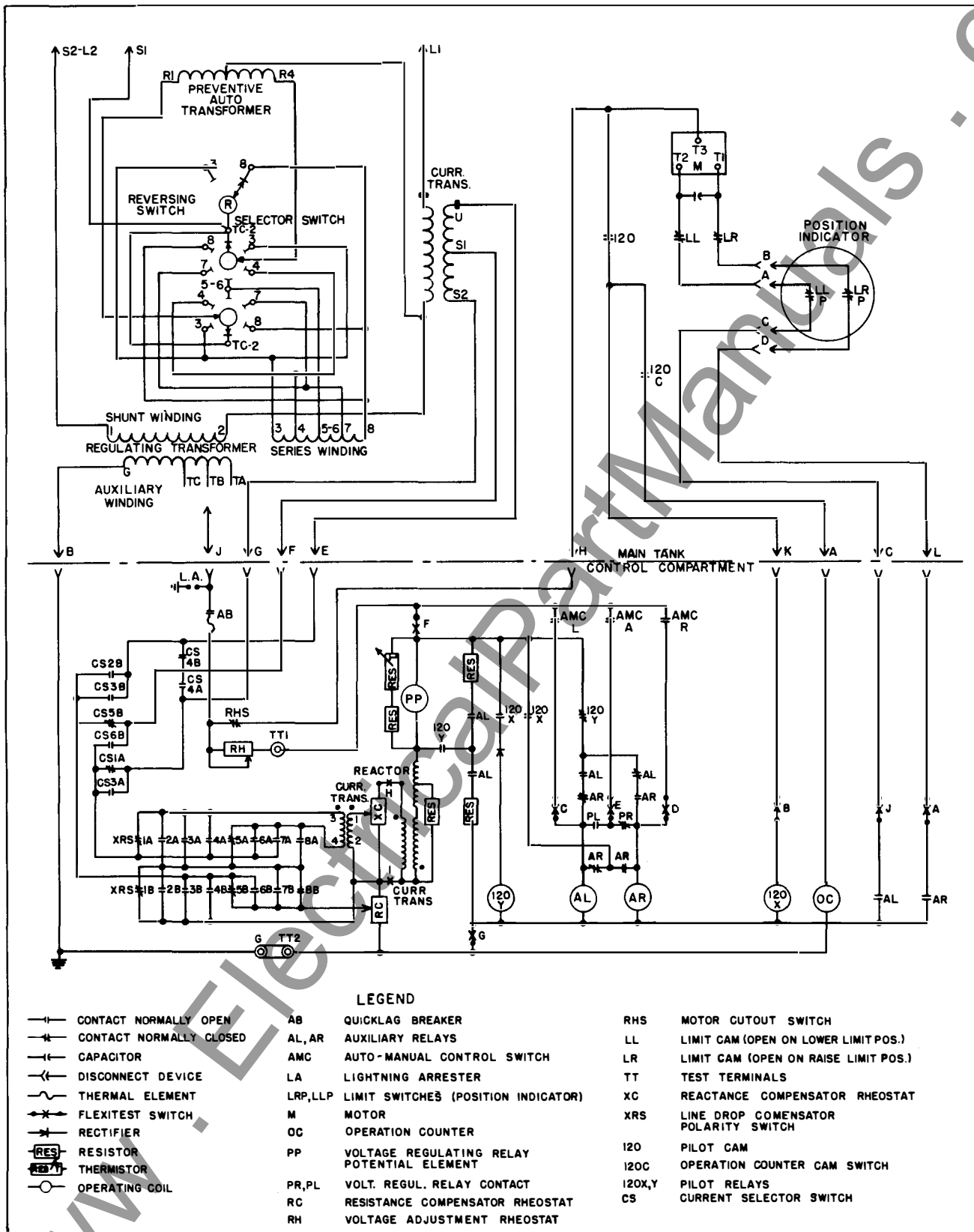

Fig. 15 - Schematic Diagram of Typical URL Regulator

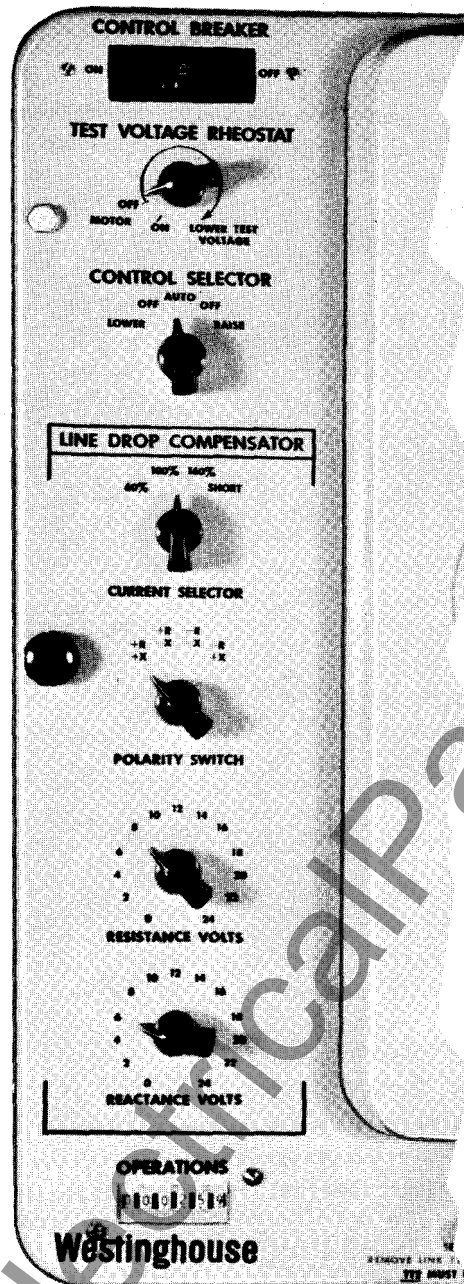

Fig. 16 - Typical Adjustment and Control Switches Associated with the CVR Relay

and voltage adjusting rheostat. The knob is in the MOTOR-ON position for normal operation. With the knob on or past the MOTOR-OFF position, auxiliary voltage is applied to the control circuit through the voltage adjusting rheostat. This rheostat provides a means of varying the voltage applied to the control for test purposes. When on or past the MOTOR-OFF position the motor circuit interlock switch is open, preventing the tap changer from operating in response to voltage variations caused by use of the rheostat.

The five position Control Selector switch, LOWER-OFF-AUTO-OFF-RAISE serves as a combination automatic-manual and raise lower switch. When the switch is on AUTO position, the regulator is on fully automatic operation. When the switch is turned to any other position, the regulator is being manually controlled.

The regulator is equipped with line drop compensation set by the four knobs on the lower left portion of the control panel. The Resistance and Reactance Volts settings determine the resistance or reactance volts inserted into the control circuit when rated line drop compensation current is flowing. The Current Selector Switch connects proper taps of the current transformer so that rated current flows in the line drop compensator when the line current through the regulator is 60%, 100% or 160% of the nameplate current rating. The switch should always be on the short position when the CVR relay is removed from its case.

The polarity switch is set on the + R + X position for normal operation, on + R - X for paralleling units by reverse reactance, and on any position as required by the Wagner scheme for operation of units in delta or open delta.

Detailed instructions for setting the line drop compensation are outlined in IB 41-431-7.

Operation

LOAD TAP CHANGER

A diagram of connections of the typical URL Regulator is shown schematically in Figure 15. For any particular regulator the diagram listed on the regulator instruction plate should be used for detail connections. The instruction plates do not show the control circuit connections. The taps from the regulating transformer windings are brought to load tap changer contacts for automatic $\pm 10\%$ regulation.

All load switching is performed by the selector switches and all arcing is confined to them. The URL tap changer has a broad band neutral, actually five neutral

positions, as shown in Table IV. The output voltage is the same for all five neutral positions. The regulator may be by-passed on any one of these neutral positions but the tap changer should be on assembly neutral, which is marked N on the position indicator, when the unit is to be untanked or dismantled. In this position the selector switch moving contacts are in a vertical position with the upper moving selector contact pointing upward and the lower moving selector switch pointing downward.

The operator may stop the tap changer on any one of the five neutral positions, and on automatic operation the tap changer may stop on any of the neutral positions also. When the regulator is operating automatically the tap changer will usually stop on the first position inside the neutral band

TABLE IV
Sequence of URL Tap Changer Operation

POSITION	REVERSING SWITCH CONNECTS R TO	SELECTOR SWITCH CONNECTS R1 TO	SELECTOR SWITCH CONNECTS R4 TO
8	8	3	3
L 7	8	3	4
O 6	8	4	4
W 5	8	4	5-6
E 4	8	5-6	5-6
R 3	8	5-6	7
2	8	7	7
1	8	7	8
N			
E	8	8	8
U	8	8	TC-2
T N	3	TC-2	TC-2
R	3	TC-2	3
A	3	3	3
L			
1	3	3	4
R 2	3	4	4
A 3	3	4	5-6
I 4	3	5-6	5-6
S 5	3	5-6	7
E 6	3	7	7
7	3	7	8
8	3	8	8

when the neutral output voltage satisfies the voltage requirements.

The complete sequence of operation is outlined in Table IV. The reversing switch R moves from contact 3 to 8 to connect the series winding to lower the load voltage from the source voltage before selector contact R1 moves from TC-2 to 8 so that R does not break load current.

When a tap changer operation is initiated either manually or automatically, the motor starts and the 120 cam operated switch closes. The 120 cam operated switch maintains the operating circuit until just ahead of the next position so that the tap changer will definitely move to the next position when an operation is initiated.

Consider a typical sequence of operations starting with the tap changer on the neutral position nearest position 1 LOWER, with both moving selector switch contacts on tap 8, and the tap changer operating in the lower direction. When the motor is started, closing the 120 switch, the tap changer runs automatically until one moving contact stops on tap 7 while the other contact remains on tap 8. This is position 1 LOWER on the position indicator. Position 1 LOWER connects the preventive auto R1 to R4 in parallel with or bridging one section, 7 to 8 of the series winding. This is referred to as a bridging position. The next operation of the tap changer moves the other contact from tap 8 to tap 7. This is position 2 LOWER on the position indicator. On this position the preventive auto is short circuited.

CONTROL OPERATION

Exact details of control may vary slightly for different special units as shown by the wiring diagrams supplied with the particular equipment but in general the control functions are as follows: The control selector switch has five positions reading from left to right: LOWER, OFF, AUTO, OFF, and RAISE. For manual control in the lower direction placing the control

selector switch on LOWER closes the AMCL contact and energizes the AL relay, which closes contact AL and operates the tap changer in the lower direction. Placing the control selector switch on RAISE closes the AMCR and operates AR which closes contact AR which operates the tap changer in the raise direction.

For automatic operation the control selector switch is turned to AUTO. This closes the AMCA contact connecting the circuit so that the CVR Voltage Regulating Relay contacts PL and PR initiate the tap changer operation.

If the voltage falls below the PR (left hand) contact setting long enough for the disc operated PR contact to close, the auxiliary relay AR is energized and seals itself in through the normally closed 120Y relay contact. Closing the AR relay, starts the motor and causes the tap changer contacts to move to raise the voltage. Before the tap changer arcing contact has opened, the 120 cam-operated pilot switch closes to energize the 120X relay which takes over the sealing of the AR relay through the 120X contact and operates the 120Y slug delay relay. The normally open 120Y relay contact closes and shorts the reactor with a 3000 ohm resistor to cause the disc to rotate and open contact PR so that there is only one tap changer operation at a time. After the tap changer arcing contact has closed on the next position the 120 pilot switch opens allowing the 120X relay to de-energize the AR relay. The tap changer motor is then stopped by the spring loaded brake cam. If the voltage change is not adequate to correct the error the tap changer sequence is repeated after short time delays until the voltage is corrected or a tap changer limit is reached. If the voltage rises until the right hand PL contact closes, a similar sequence operates to lower the voltage.

When the control is de-energized, the CVR Relay contact PR is closed. Therefore, immediately upon energizing the circuit, the AR relay energizes & initiates the operation of the tap changer one position in the raise direction.

POSITION INDICATOR

Auxiliary limit switches built into the position indicator provide "Load Range Selection".

Detents are provided to insure that the range limit selected will coincide with a tap changer position. When the operator wishes to take advantage of the increased current rating provided by Load Range Selection the tap changer should be run to a position within the desired operating range. Otherwise, the new limits will not become ef-

fective until the tap changer does get into the new operating range.

For example, if the tap changer were on position 6 RAISE, and the new limits were changed to position 4R (5% raise), the tap changer would not move upward from position 6, but it would run toward neutral when called upon to do so. After moving downward to position 4R, the limit would become effective and the tap changer would not raise above position 4R. Thus it is desirable to run the tap changer to within the limits selected when some limit other than 10% has been selected.

Maintenance

INSPECTION

Type URL Voltage Regulators are designed for minimum maintenance. The first inspection should be made before the end of the one year warranty period so that any faults found can be corrected within the warranty. The second inspection should be made at the end of the next ten years or 400,000 operations, whichever comes sooner.

The relays should be checked for proper operation and for tight connections.

Maintenance of the selector switch contacts will depend upon the load which the regulator is called upon to carry and the frequency of tap changer operations. The arcing tips of the selector switch contacts are made of a special arc resisting alloy to insure long life. These contacts should be inspected at the time of periodic inspection and should be replaced when necessary.

Replacement should be made before the moving finger shoes have burned sufficiently to reduce the smooth flat contact width to less than 1/4 inch and before the stationary contacts burn into the base material to which the arcing tips are brazed.

The oil in the tap changer compartment should be replaced or reconditioned when it tests less than 26 KV in the standard test cup. Under no condition should the tap changer be operated if the oil drops below 22 KV. The oil level in both compartments should be checked at the time of the periodic inspection.

Whenever oil is drained from the tap changer for inspection or maintenance, it is preferable that new, clean, dry, and filtered oil be returned to the tap changer compartment. If for any reason it is found necessary to reuse the same oil which was drained from the tap changer, the following precautions must be taken.

1. Be sure the drums used for oil storage are absolutely clean and dry. Inspection of the drums will save much grief.
2. Be sure the oil is filtered before it is returned to the tap changer compartment to remove any carbon, metal particles, or water which might have been present or introduced in handling.
3. The oil should be free of carbon before it is considered satisfactory.
4. After filling the tap changer compartment with oil and before energizing the unit, test at least three representative samples

in the standard test cup. The test value should be 26 KV or better.

5. The regulator should never be energized when the oil in the housing tests less than 22 KV in the standard test cup.

Instruction book IB 45-063-100 covers the testing of WEMCO® "C" and WEMCO® "CI" oils. The oil level in the main tank should be checked at the time of periodic inspection. A combination sampling and drain plug for checking the oil in the regulator is provided at the bottom of the tank, and one for checking the oil in the tap changer is located to the left of the control cabinet.

The diagram of connections for control equipment is shown on the wiring diagram furnished with the apparatus and is referenced on the nameplate. The internal high voltage connections for the regulator and the tap changer are shown on the diagram nameplate.

The operating mechanism is entirely immersed in oil which protects it against rust and insures proper lubrication.

CVR RELAY MAINTENANCE

The proper adjustments to insure correct operation of this relay have been made at the factory and should not be disturbed after receipt by the customer (with the exception of bandwidth or time delay settings). Repair work can be most satisfactorily done at the factory. IB 47-431-7, covers the setting and adjustment of the voltage regulating relay.

Before opening the Flexitest switches, switch the "Control Breaker" on the panel to "OFF", set "Current Selector" to "Short" and set "Control Selector" to "OFF".

CORRECTION OF MINOR TROUBLES

The following procedure is suggested in case the motor fails to operate.

1. Check voltage on the voltage test terminals with a voltmeter. If there is no voltmeter handy, the CVR Voltage Regulating Relay may be read to indicate the magnitude of voltage. If the voltage is high, the right hand contact of the CVR will close and if the voltage is low the left hand contact of the CVR will close.

2. If the load center voltage is low and the tap changer is at its upper limit position, as determined by the Load Range Selector Setting, the source voltage may be so low that the range of regulation is inadequate to correct the output voltage level.

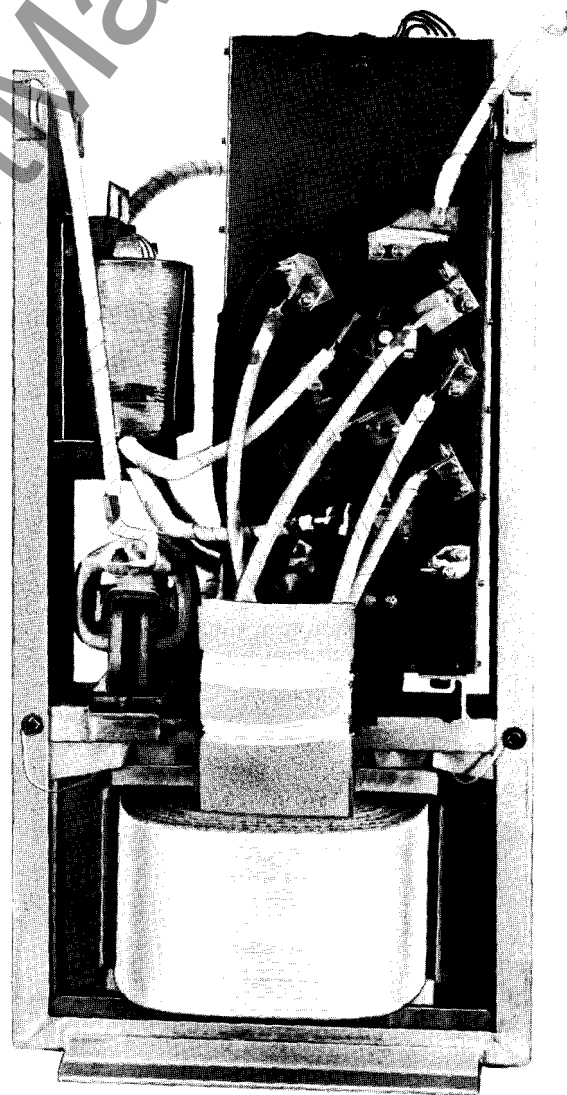

Fig. 17 - VRL Internal Assembly removed from tank

If the load center voltage is low and the regulator is not on its upper limit position, it is possible that the voltage is too low to operate the control. (The relays and the tap changer will operate with 80% on the regulator output terminals.) If the output is above this minimum, further systematic checks are required.

3. If either AL or AR relay is closed, check to see that voltage appears across the motor leads T3 to LL or LR on the schematic.

4. If there is voltage at the motor terminals but it does not start:

a. The motor may be open circuited. Each half of the motor winding should have about 25 ohms resistance for motor style 237A787HO1.

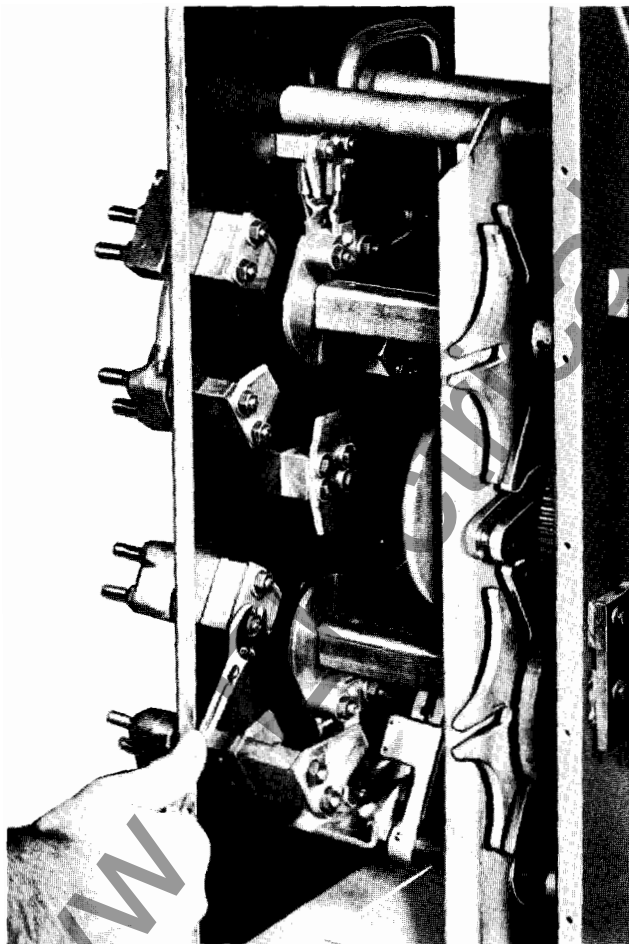

Fig. 18 - Removing Stationary Contact from URL Tap Changer

b. The capacitor may be open. The capacitor is 15 mfd., 300 volts, 60 cycles; in emergency cases a capacitor of at least this value may be substituted for the capacitor in the unit. The capacitor is located at the top of the tap changer immediately below the handhole cover.

c. There may be foreign material between the motor pinion and gear causing gears to bind.

5. If the voltage regulating relay is energized but does not respond to voltage changes, see IB 47-431-7, for more detailed information.

MAJOR OVERHAUL AND REPAIR

If periodic inspection has shown that arcing contacts should be replaced and such contacts have been obtained, the following procedure is recommended.

1. Put the regulator on neutral position, disconnect it from the line and, if pole or platform mounted, lower it to the ground. Remove the handhole cover on the cover of the regulator. Remove the oil from both the regulator and the tap changer compartments.

2. Disconnect the three bushing leads by removing the adapters and bushing caps and remove the cover.

3. Remove one of the cotter pins which keeps the cover-clamp beam in position and remove the cover-clamp beam.

4. Disconnect the control connector from the tank wall.

5. Remove the bolts clamping the vertical uprights to the tank. Disconnect the flexible shaft running from the tap changer to the position indicator. This may be done by loosening the connecting nut where the flexible shaft connects to the position indicator inside the tank.

6. Remove the tap changer sump drain plug on the outside of the tank to the left of the control cabinet. Remove tap changer sump drain pipe with a pair of pliers.

7. The complete core and coil assembly including the tap changer can now be lifted out of the tank. After removal from the tank, the coils should be kept dry and clean. See Figure 17.

8. Remove the side panels from the tap changer to provide room enough to replace the arcing contacts. See Figures 18 and 19.

9. The control leads may be connected to the control cabinet and the tap changer may be operated by applying test voltage to the test terminals. Be sure to open the control breakers before applying external voltage.

10. Reassembly should be carried on in reverse of the process outlined above. Be sure that the position indicator points to the position corresponding to the actual location of the tap changer when the unit is reassembled. The moving contacts are vertical when on the neutral position, the upper one pointing upward and the lower one pointing downward.

11. If the same oil is to be put back into the regulator and tap changer, it should be filtered back. If no filter is available, clean oil should be put into the tap changer compartment and regulator tank. It is always advisable to check the dielectric strength of oil which is put into a regulator or transformer before energizing the unit.

12. When re-assembling the cover assembly to the unit, it is recommended that the cover bolt be pulled down snug. The bushing caps should then be assembled to the bushings. As a final step, tighten the cover bolt to a torque of 60 lb.-ft.

TEST AFTER OVERHAUL AND REPAIR

1. Apply 120 volts to the motor and run the tap changer thru its entire range and return. Be sure there is no binding and that the mov-

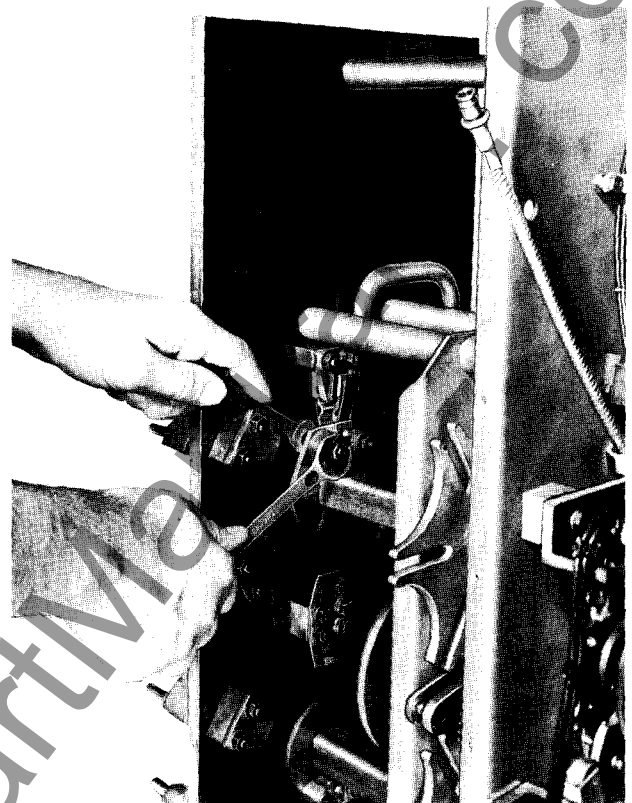

Fig. 19 - Removing Moving Contact from URL Tap Changer

ing contacts change position rapidly. Open the control circuit breaker before applying voltage to the unit.

2. After tanking, the tap changer and control should be tested by energizing the control as per page 11. The Load Range Selector limit switches should be checked on every position to insure that the tap changer will be limited by the switch. The Load Range selector limit switches are in series with limit switches that are part of the tap changer. The tap changer switches operate on positions 8R and 8L, and, in effect, back up the operation of the LRS limit switches. When on a limit position, the motor should not be energized by the Manual Control or CVR Relay. If the motor does become energized, it indicates that the position indicator was not on position when connected to the tap changer by the flexible shaft or that the limit switches have been somehow rendered inoperative.

SPARE PARTS

The customer will find that a minimum of spare parts will be required for the URL Regulator. If so desired, a set of stationary and moving arcing contacts for the load tap changer may be kept in stock. It might be desirable to stock one set of cover gaskets, one bushing and one ValvEx® arrester. A CVR Voltage Regulating Relay and Flexi-test plug S#1164046 may be purchased and will permit complete replacement of the relay in less than a minute. The plug permits complete testing of the relay on the test bench with convenient slip connections.

The following list of items and corresponding Westinghouse style numbers is provided for ease of identification should the need arise for ordering spare parts.

Parts common to all Ratings:
 Style Number
 Tap changer motor assembly 237A788 Gr. 1
 Motor capacitor 1585274
 Selector finger assembly
 (moving contact) 55D3311G01 Req. 2
 Stationary contact 1575995 Req. 12

CVR Voltage
 Regulating Relay S#1961157
 Position indicator gaskets 231A694H01
 Position indicator 592D535G01
 Position indicator glass
 and Bezel kit S#455C606G01
 Hand hole cover gaskets S#1800009
 Cover gasket S#247A453H01
 Parts not common for all ratings:

RATING	STYLE NUMBER	
	Bushing	ValvEx Arrester
2,500 V	592D544 Group 4	1800354
5,000 V	592D544 Group 4	1771455
7,620 V	592D544 Group 5	1771457
13,800 V	592D544 Group 5	1800355

SUPPLEMENTARY DATA

Supplementary data consists of the following Instruction Booklet IB 47-431-7.

