

565/575 FEEDER MANAGEMENT RELAY®

Instruction Manual

Software Rev: E2.73
Manual P/N: 1601-0017-E6
Copyright 1996 GE Multilin



MULTILIN

CANADA
215 Anderson Avenue, Markham, Ontario, L6E 1B3
Tel: (905) 294-6222 Fax: (905) 294-8512

USA
9746 Whithorn Dr., Houston, Texas, 77095
Tel: (713) 855-1000 Fax: (713) 859-1091

SECTION 1: INTRODUCTION

Protection Requirements of Feeders	1-1
565 Relay Features	1-1
Setpoint Programming	1-1
Inputs	1-1
Outputs	1-1
Memory Features	1-1
Typical Applications	1-1
Ordering Information	1-1

SECTION 2: INSTALLATION

Unpacking the Unit	2-1
Mounting the Relay	2-1
Making Wiring Connections	2-1
Power Supply Connections	2-1
Surge Ground Connection	2-1
Current Transformers	2-1
Voltage Transformers	2-1
Breaker Status and Control Connections	2-4
Aux 1 Contacts	2-4
Aux 2 Contacts	2-4
Aux 3 Contacts	2-4
Aux 4 Contacts	2-4
Programming Port	2-4
Communication Port	2-4
MTM Port	2-4
Printer Port	2-4
Analog Output Terminals	2-5
Analog In Terminals	2-5
External Switches 1 to 8	2-5
Access Terminals	2-5
Remote Trip/Close Terminals	2-5
Removal of Cradle	2-5
Inserting Cradle	2-5
Metering Transducer Module	2-5
Hi-Pot Testing	2-6

SECTION 3: PROTECTION APPLICATION INFORMATION

Overcurrent Protection	3-1
Use of Standard Curves	3-1
Use of Custom Curve	3-1

SECTION 4: DISPLAY AND KEYBOARD

Display Modes	4-1
Actual Values Mode	4-1
Setpoints Mode	4-1
Help Mode	4-2

SECTION 5: ACTUAL VALUES MODE

Default Message Selection	5-1
Actual Values Message Abbreviations	5-1
Summary of Actual Value Page Contents	5-2
Actual Values	5-3

SECTION 6: SETPOINTS MODE

Relay Selection	6-1
Setpoint Message Abbreviations	6-1
Summary of Setpoint Page Contents	6-3
Factory Default Setpoints	6-4
Setpoints	6-8
Installation of Security Feature:	6-10
Use of Access Code:	6-10

SECTION 7: FEATURE INFORMATION

Event Recording Information	7-1
AEG MODICON MODBUS PROTOCOL	7-6
Memory Map Information	7-11
Metering Specification - 565 with MTM	7-23

SECTION 8: RELAY TESTING

Primary Injection Testing	8-1
Secondary Injection Testing	8-1
Phase Current Input Function Check	8-1
Phase Instantaneous Pickup and Trip Check	8-1
Phase Overcurrent Curve Verification	8-1
Ground Current Input Function Check	8-3
Ground Instantaneous Pickup and Trip Check	8-3
Ground Curve Verification	8-3
Voltage Input Function Check	8-4
Undervoltage Trip and Alarm Check	8-4
Overvoltage Trip and Alarm Check	8-4
Output Relay Functional Check	8-4
Analog Input Function Check	8-4
Analog Output Function Check	8-4
Power Loss Check	8-4

SECTION 9: TECHNICAL SPECIFICATIONS

Technical Specifications	9-1
--------------------------------	-----

APPENDIX A

Customer service	A-1
------------------------	-----

APPENDIX B

Troubleshooting guide	B-1
-----------------------------	-----

APPENDIX C

Block Diagrams	C-1
----------------------	-----

APPENDIX D

Curve: Normal Inverse	D-2
-----------------------------	-----

LIST OF FIGURES

Protection Requirements of Feeders

Protection of three phase feeders is necessary to avoid equipment damage and personnel injury during fault conditions. The fact that continuous reliable power must be provided to the distribution network means that the feeder protection relay must protect the network and personnel and yet not cause unnecessary loss of power or nuisance tripping.

The ideal Feeder Management Relay should at least monitor phase current, ground current and voltage in the network, provide indications if any of these reach predetermined levels and provide appropriate trip signals if fault conditions develop.

The advent of current microprocessor technology has enabled the development of feeder management relays which do this task much better than conventional relays and provide other desirable features. Measured values of phase current, ground current and voltage can be displayed.

Entering setpoints to the microprocessor based Relay is made easier by use of a keypad and a LCD display to guide the user. A "help" menu is available at all times.

Relay Features

The Multilin Feeder Management Relay is designed to provide complete and accurate feeder protection under all operating conditions. The relay provides complete Time/Overcurrent phase and ground protection by monitoring feeder phase currents and ground currents. These are sensed by current transformers (CT's).

Overcurrent phase and ground current trip setpoints are programmed by a comprehensive selection of industry standard curve shapes including moderately inverse, normal inverse, very inverse, and extremely inverse. In addition to the pre-selected curves there is also a programmable custom curve. If none of the pre-selected curves are suitable for the application, the user can enter his own data to form the custom curve.

Setpoint Programming

The relay can have its setpoints programmed locally, from the front panel. In this case the alphanumeric display guides the user through the setup, step by step, giving clear English language instructions. There is also a HELP key which can be pressed at any time to get information and assistance about the current programming step.

The status of the system is clearly displayed at all times by LED indicators and more detailed information can be shown on the display screen if requested through the keypad.

When an output relay is activated to cause a trip/alarm the Relay will display the cause of the trip/alarm.

All setpoints are tamper-proof. This is achieved through the use of a combination of a Access wire jumper at the back of the relay and personalized codes. These codes allow even the wire jumper to be overridden, for added security.

Inputs

The Relay has inputs which can be used for indication of breaker status or external differential trips such as the industry standard '87T'.

One set of inputs is designated "Analog Select", and can be connected to four dry contacts of a programmable logic controller (PLC). Selected outputs can be requested one by one, through these inputs by the PLC. Information can be requested on values such as individual phase currents and the Relay will send the requested value through the analog output terminals in either 0-1mA or 4-20mA format as required.

Outputs

Six electromechanical output relays are included in the 565/575 Relay. These are named Trip, Close, Aux. 1, 2, 3, and 4. These relays can be allocated various functions, by using the flexibility of the software programming.

Actual value and Setpoint information is sent out through the RS485 port on the rear of the relay. *** An RS232 printer driver port is also available for printing out events from the event recorder if an Option Card is installed. *** In addition, a front panel RS232 programming port is provided.

Memory Features

In order to simplify fault analysis and thus improve system reliability, several memory features have been built into the Relay. The event recording feature provides a record of the events leading to a trip so that the faulty feeder system component can be located easily.

The memory feature provides a record of the cause of all trips. This is extremely useful in determining preventive maintenance requirements and identifying problem areas.

Typical Applications

The Relay is ideally suited for primary protection of medium and high voltage distribution systems.

INTRODUCTION



Ordering Information

To order the Feeder Protection Relays you must specify it as shown in Figure 1.1.

Many features of the Relay are field programmable. Those

listed in Figure 1.1 are not, and must be specified when ordering.

Additional features may be available for special orders. Contact GE MULTILIN for further details.

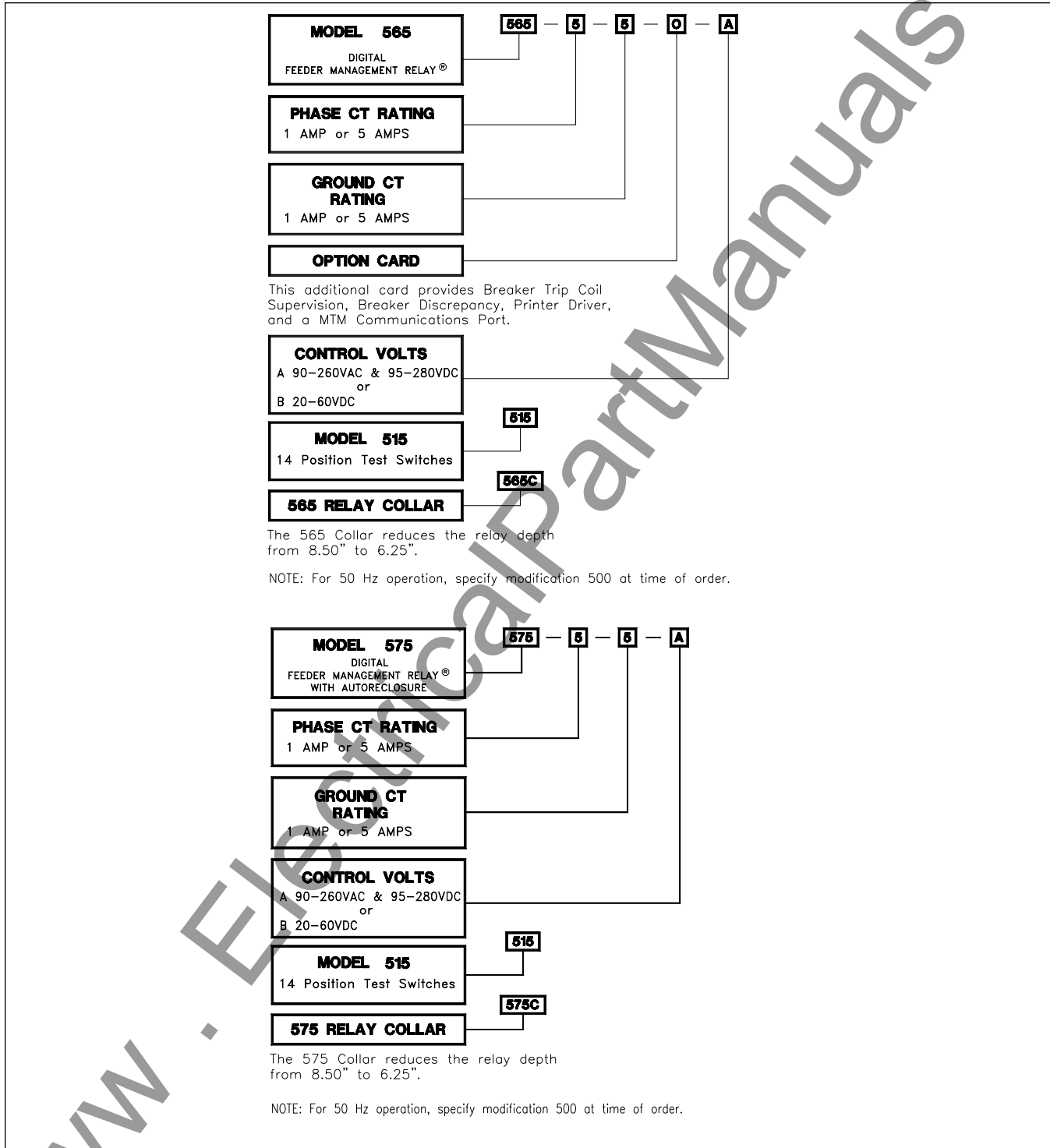

Figure 1.1 Order Codes

Unpacking the Unit

The shipping container should contain your Relay and this manual. Inspect the unit and inform GE MULTILIN of any damage. If re-shipment is required the original container and packing should be used.

Mounting the Relay

The Relay is designed to be panel mounted. It should be located so that the keypad is accessible with the door opening from the right. The unit should be mounted so that the display is easily visible. It is recommended that the relay be mounted as far away as possible from heavy current sources and strong magnetic fields.

The 4 mounting studs of the Relay are equipped with (1) #10 internal star lockwasher, (1) 10-32 threaded hex spacer 0.25" long, (1) #10 split lockwasher, and (1) 10-32 hex nut. Remove only the split lockwasher and the 10-32 hex nut before installing the Relay in the panel. Then use this split lockwasher and hex nut to secure the Relay in the panel.

The dimensions of the unit and the necessary cutout dimensions are shown in Figure 2.1.

To reduce the required space behind the mounting panel an optional depth reducer is available. This reduces the depth to 6.25". It increases the width of the front panel to 15.33". For mounting dimensions see Fig. 2.2.

Making Wiring Connections

All wiring connections to the Relay are made at the back of the unit as shown in Figure 2.10. All terminals are also identified in Table 2-1 with their functions.

Figure 2.5 shows the connections for a typical installation. The actual connections made to the Relay will vary according to the application. All contacts in the figure are shown in the state they will have with control power applied to the unit. The contacts are shown in the "non-active" state.

The relay can be removed from the outside case for the purpose of checking and/or calibration. The wiring is to the outside and remains intact.

WARNING

Extreme caution must be exercised when the chassis is withdrawn from an in service unit as this exposes live terminals.

Power Supply Connections

Depending upon the ordered power supply, the Relay is

designed to operate within one of the following voltage ranges:

1. 90-260 VAC and 95-280 VDC
2. 20-60 VDC

No internal or external adjustments are required to use any of the above supply voltages.

Power supply connections are made at terminals 63 and 64. The relay is grounded by connecting terminal 62 directly to the dedicated ground entering the switchgear enclosure.

Surge Ground Connection

For safety and optimum noise immunity due to transients, a low impedance connection must be made between the surge ground terminal and the switchgear ground. This must be a separate, dedicated wire tied directly to the switchgear copper bus strip (flat, braided wire is ideal).

CAUTION

FAILURE TO MAKE PROPER GROUND CONNECTIONS MAY CAUSE DAMAGE TO THE RELAY.

Current Transformers

The three current transformers supply the Relay with currents proportional to the current in each of the phases of the feeder being protected. They are connected to terminals 49 to 54 as shown in Figure 2.5. Observe correct polarity when connecting the current transformers to the unit.

The CT terminal with the dot marked on it must be connected to the terminal marked ":5/1". Each CT should have the same physical orientation, with polarity connected as shown in Figure 2.5. The sides of the CT which are not marked with a polarity dot are connected together and grounded.

Residual ground sensing is provided by connecting the common terminals of the three CTs together through the ground sensing input terminal 56 as shown in the wiring diagram, Figure 2.5. These connections allow the relay to check the vector sum of all three phase currents. If this is not zero, a ground fault condition is sensed by the unit.

For typical CT wiring of the Relay with the optional Metering Transducer Module (MTM) see Figure 2.7A and Figure 2.7B.

Voltage Transformers

Separate voltage transformers are needed for voltage sensing and terminals 35 to 38 are used for this. The transformers can be connected in either Wye or Open Delta configuration as shown in Figure 2.6.

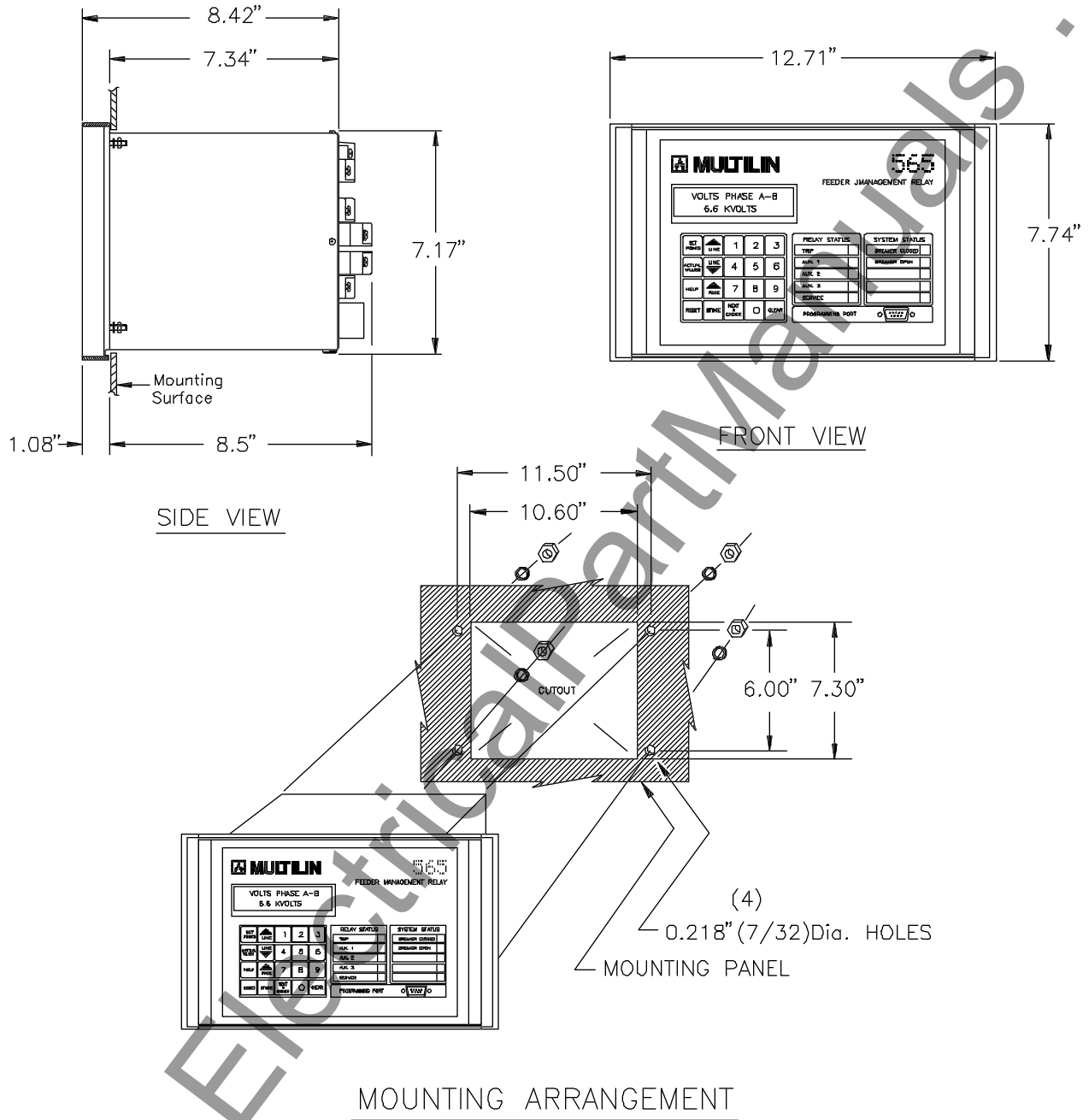
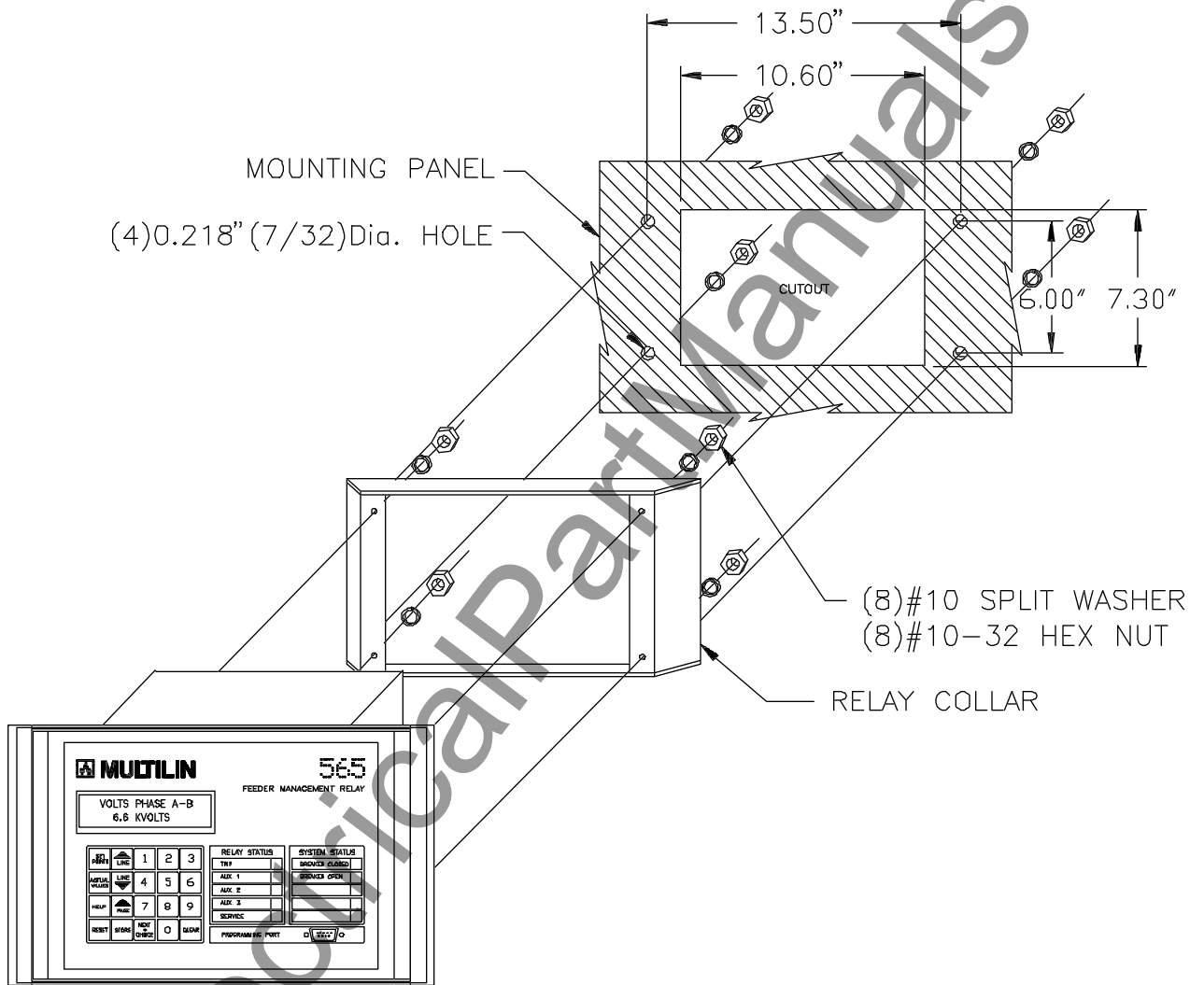

Figure 2.1 Mounting Details

985173E4.DWG



MOUNTING ARRANGEMENT

985225E4.DWG

Figure 2.2 Mounting Arrangement with Relay Collar

INSTALLATION



Breaker Status and Control Connections

The Feeder breaker status indications are given to the Relay from the auxiliary 52a/52b contacts on the breaker. The connections are made to terminals 9 and 10 for the Breaker open indication (52b) and at terminals 11 and 10, for breaker closed (52a) as shown in Figure 2.5. The breaker status input connections must be made.

Aux 1 Contacts

The contacts of the Aux 1 are 43 N.O., 59 common, 46 N.C. This relay function is programmable.

Aux 2 Contacts

The contacts of Aux 2 are 44 N.O., 60 common, 47 N.C. This relay function is programmable.

Aux 3 Contacts

The contacts of Aux 3 are 45 N.C., 61 common, 48 N.O. This relay is hot coil failsafe and monitors control power loss, and trip coil supervision. It is not programmable.

Aux 4 Contacts

The contacts of Aux 4 are 30 N.O., 31 common, 32 N.C. This relay activates on a Breaker Discrepancy function if enabled.
** Available only with Option Card **.

Block Tap Changer (575 only)

The contacts of the Block Tap Changer are 16 N.O., 15 common, and 26 N.C. This relay operates to block operation of an external transformer tap changer. It also acts as "Auto Reclosure in Progress" indicator.

Programming Port

A programming port (RS232 type) is supplied on the front panel of the relay. This port can be connected to a computer which then can be used to store setpoints in and read measured values from the relay.

This port has priority over the communication port on the rear. If the relay senses the DTR line being pulled high, all communications at the rear are suspended.

The connection to a computer is made via a standard modem type cable and is shown in figure 2.3.

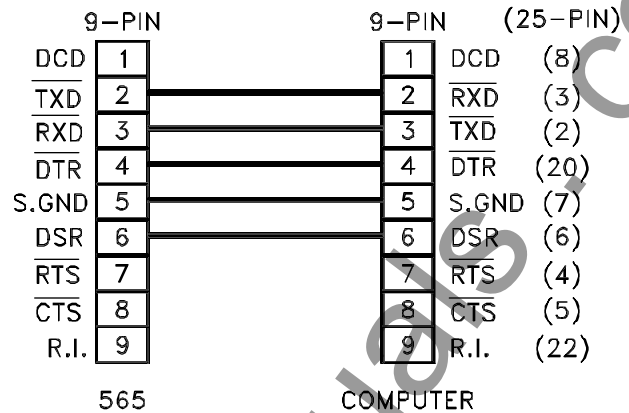

985213E3.DWG

Figure 2.3 Computer Interface Cable for RelayCom Package

Communication Port

Up to 32 relays can be daisy-chained together and connected to a computer or a programmable controller using the RS485 type communication port in the rear. A shielded twisted pair should be used and proper polarity has to be observed, ie. positive to terminal 65, negative to terminal 66, while the shield is connected to terminal 67.

After each 565/575 Relay is assigned a unique address, the master device (computer) can read measured values or store setpoints. The address is assigned via the keypad on the front panel. See also Programming Port information above.

MTM Port

The MTM port, terminals 67, 68, and 69, is required when connecting the separate MTM Metering Transducer Module to the 565/575 Relay. The MTM receives current and voltage inputs and calculates KW, KVAR, PF and transmits the information to the 565/575 Relay. The connections are made by means of a shielded twisted pair of length no greater than 50 ft. MTM port polarity must be observed, ie. positive to 68, negative to 69, and the shield to 67. ** Available only with Option Card **.

Printer Port

The printer port can be used to connect a printer to record event recording output. This is a 1200 baud serial output with even parity and requires the printer to accept serial data. The word length is eleven bits with the data frame constructed as follows: there is a start bit (Low), eight data bits (LSB to MSB), an even parity bit, and a stop bit (High). The connection is made at the rear of the relay via a 9 pin D-type null modem connector. The pinout is as follows:

- 2 = transmit data to printer
- 3 = receive data from printer
- 4 = Clear To Send from printer
- 5 = signal ground.

See your printer manual for connections at the printer. *** Available only with the Option Card installed ***

Analog Output Terminals

Terminals 17 and 18 provide a single output that can be programmed as 4-20 mA or 0-1 mA to correspond from zero to full scale.

Using the analog select terminals 19-22, and 71, outputs can be selected by placing a binary code on inputs A-D. This code can be PLC controlled for changing the output selection. This allows monitoring and plotting measured values such as phase current, using a single analog input channel of a programmable controller.

If a single output parameter is desired, this is achieved through setpoint programming without external connections to inputs A-D.

Analog In Terminals

The 565/575 Relay is designed to accept an input from standard 4 to 20 mA source such as a Multilin TS3 Temperature Monitor. This input can be used to provide status or trip signals related to the level of the input, a transformer winding temperature, for example. The setup of the trip, alarm or status indications are done during the software programming in the Setpoints mode.

The input terminals are positive 24, and negative 23.

External Switches 1 to 8

The 565/575 Relay can accept switch inputs from eight external switches, through terminals 1 to 8. The function of switches 1 to 8 is user definable. They can be programmed to perform functions such as preventing certain feeder breaker trips or introducing a time delayed alarm. These features are assigned to the switches in the Configuration page of Setpoints mode.

CAUTION

External Switch inputs should be connected to dry circuits only to prevent damage to the relay.

No external voltage should be applied to these terminals as the contacts are energized internally from the 565/575 and opto-coupled to the sensing circuitry. Switches should be isolated from each other for correct operation. The maximum input impedance to these external switches is 2 k Ω .

Access Terminals

Terminals 33 and 34 can be connected to a keyswitch. The 565/575 Relay setpoints cannot be changed unless this keyswitch is closed (ie. 33 and 34 are connected together). This prevents unauthorized personnel from tampering with the setpoints once they are set up. This function can be defeated using the Security feature. Refer to Setpoint Programming.

Remote Trip/Close Terminals

When terminals 39 and 40 are "open", the 565/575 relay is operating in Local Mode. If this is the case, terminals 26, 27, and 28 will have no effect upon either the Close (terminals 42 and 58) or Trip (terminals 25, 57, and 41) output relays.

When terminals 39 and 40 are "closed", the 565/575 relay is operating in Remote Mode. Now if terminals 27 and 28 are shorted, the Close output relay becomes energized and if terminals 26 and 27 are shorted, the Trip output relay becomes energized. Note that each relay will be picked up for as long as the appropriate switch input remains closed.

This operation is completely independent of software and is strictly under hardware control.

Removal of Cradle

To remove the cradle from the case, open the door and unscrew the locking screw fasteners. The cradle can now be removed simply by pulling on the front handle. Caution should be taken when the cradle is removed as this exposes live terminals in the case.

Inserting Cradle

To insert the cradle, align the aluminum guides on the sides of the cradle with those inside the case and slide the cradle into place. Ease in with constant pressure. Once inserted, the yellow guideline should be visible. The locking screw fasteners can now be screwed in and tightened. NOTE: The locking screw fasteners should be locked at all times while the cradle is inserted to ensure that proper connection to the rear terminals is maintained.

CAUTION

Do not press on the LCD display when removing or installing the unit.

Metering Transducer Module

The Metering Transducer Module is an optional unit which gives the 565/575 additional functionality. The mounting arrangement is shown in Figure 2.9 and the typical wiring for PT's and CT's is shown in Figure 2.7A and Figure 2.7B. Additional analog outputs can be wired as shown in Figure 2.8A and Figure 2.8B.

Hi-Pot Testing

The Relay has been tested at the factory for 1 second at 1800 VAC in order to verify its dielectric strength. Hi-pot testing to verify the wiring into the gear must be done with the inner relay cradle removed from the outer case. JMP1 must be removed before Hi-pot testing. This jumper can be located by viewing Figure 2.4.

Hi-pot testing should only be performed on the terminals mentioned in the enclosed table of this addendum. With these points in mind, here are the necessary steps for Hi-potting a 565/575 Relay when wired into the gear.

1. Remove the 565/575 Relay inner chassis from the outer case. Failure to remove the relay from the outer case can cause failure of the relay.
2. Remove jumper JMP1 from the outer case's rear motherboard. Please see Figure 2.4 for this jumper's location.
3. Hi-pot the following terminals with respect to surge ground for 1 second at 1800 VAC:
 - #16
 - #29, #30, #31, #32
 - #42, #43, #44, #45, #46, #47, #48
 - #58, #59, #60, #61, #62, #63, #64
4. Ensure that jumper JMP1 is properly inserted after Hi-pot. This should be on the two right most pins of the group of three pins. If not, the unit will not be properly grounded.
5. Install the relay's inner chassis into the outer case.

Figure 2.4 Removal of Hi-Pot Screw

Table 2-1 - Terminal Identification

Terminal	Function	Terminal	Function
1	Ext. Switch #1 "+"	37	Voltage Input V3
2	Ext. Switch #2 "+"	38	Voltage Input Vn
3	Ext. Switch #3 "+"	39	43 Remote "+"
4	Ext. Switch #4 "+"	40	43 Remote "-"
5	Ext. Switch #5 "+"	41	Trip Relay N.O.
6	Ext. Switch #6 "+"	42	Close Relay Contact 1
7	Ext. Switch #7 "+"	43	Aux 1 Relay N.O.
8	Ext. Switch #8 "+"	44	Aux 2 Relay N.O.
9	Breaker Open (52b) "+"	45	Aux 3 Relay N.C.
10	Breaker Common "-"	46	Aux 1 Relay N.C.
11	Breaker Closed (52a) "+"	47	Aux 2 Relay N.C.
12	Reclosure Enable "+"	48	Aux 3 Relay N.O.
13	Reclosure Common "-"	49	Phase 1 Common
14	Reclosure Disable "+"	50	Phase 1 Input :5/:1
15	Block TC Common	51	Phase 2 Common
16	Block TC N.O.	52	Phase 2 Input :5/:1
17	Analog Out "-"	53	Phase 3 Common
18	Analog Out "+"	54	Phase 3 Input :5/:1
19	Analog Select A	55	Ground Current Common
20	Analog Select B	56	Ground Current Input :5/:1
21	Analog Select C	57	Trip Relay Common
22	Analog Select D	58	Close Relay Contact 2
23	Analog In "-"	59	Aux 1 Relay Common
24	Analog In "+"	60	Aux 2 Relay Common
25	Trip Relay N.C.	61	Aux 3 Relay Common
26	Remote Trip "+"	62	Control Voltage GND
27	Remote Common "-"	63	Supply Voltage "+"
28	Remote Close "+"	64	Supply Voltage "-"
29	Block TC N.C.	65	RS485 Port "+"
30 **	Aux 4 Relay N.O.	66	RS485 Port "-"
31 **	Aux 4 Relay Common	67	MTM/RS485 Shield
32 **	Aux 4 Relay N.C.	68 **	MTM RS485 "+"
33 **	Access Switch "+"	69 **	MTM RS485 "-"
34 **	Access Switch "-"	70	IRIG-B
35	Voltage Input V1	71	Analog Select Common
36	Voltage Input V2	72	Ext. Switch Common

575 only
575 only

** 565 requires Option Card

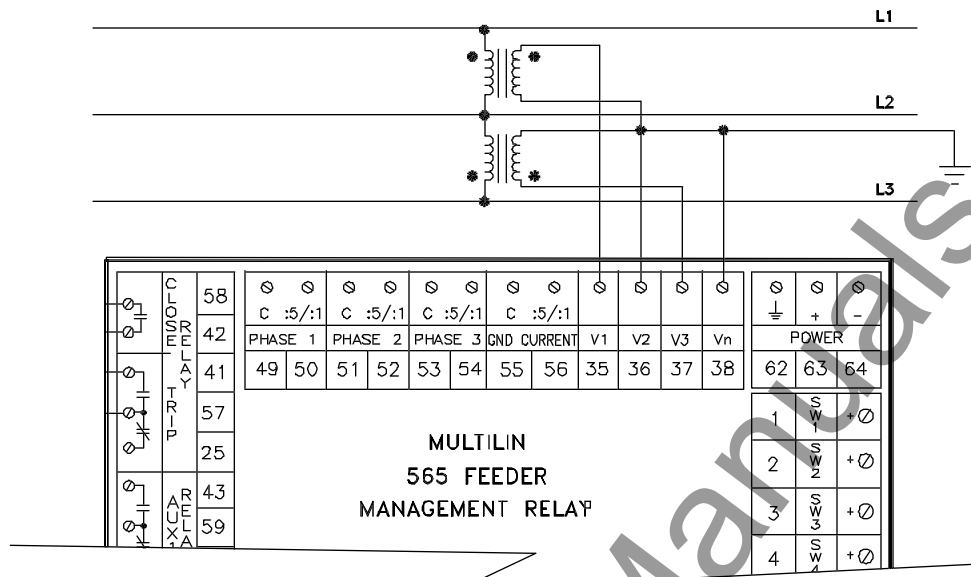

VOLTAGE TRANSFORMER CONNECTIONS – OPEN DELTA SYSTEM

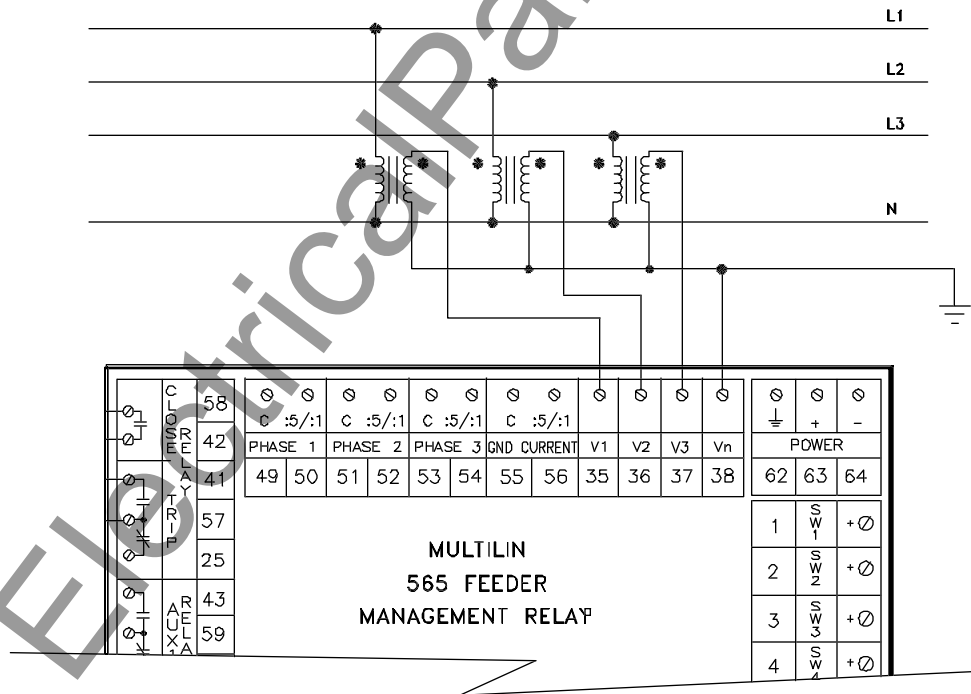

VOLTAGE TRANSFORMER CONNECTIONS – WYE SYSTEM

985174E2.DWG

Figure 2.6 Voltage Sensing Wire

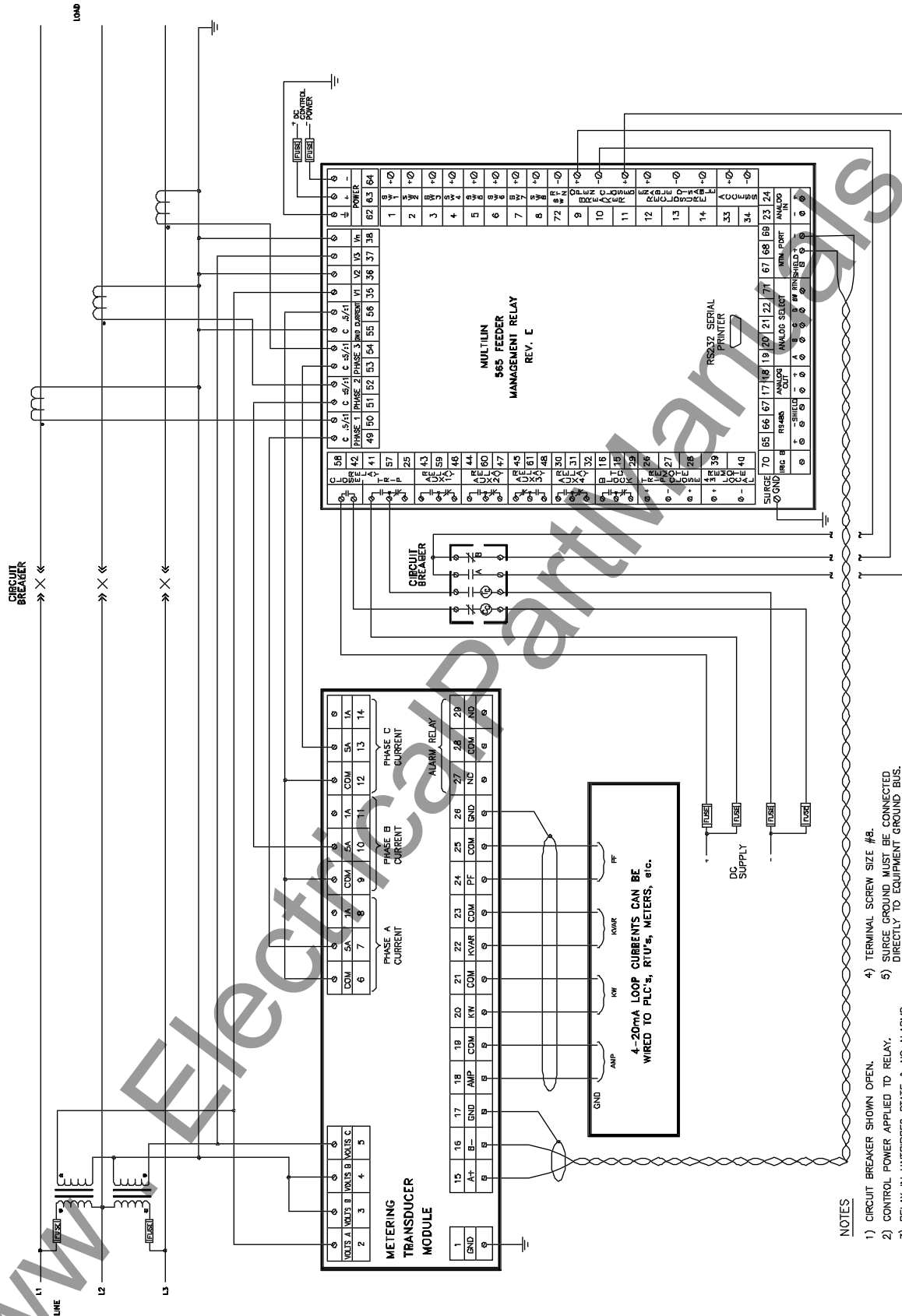

Figure 2.7A 565 with MTM CT and Open Delta VT Typical Wiring

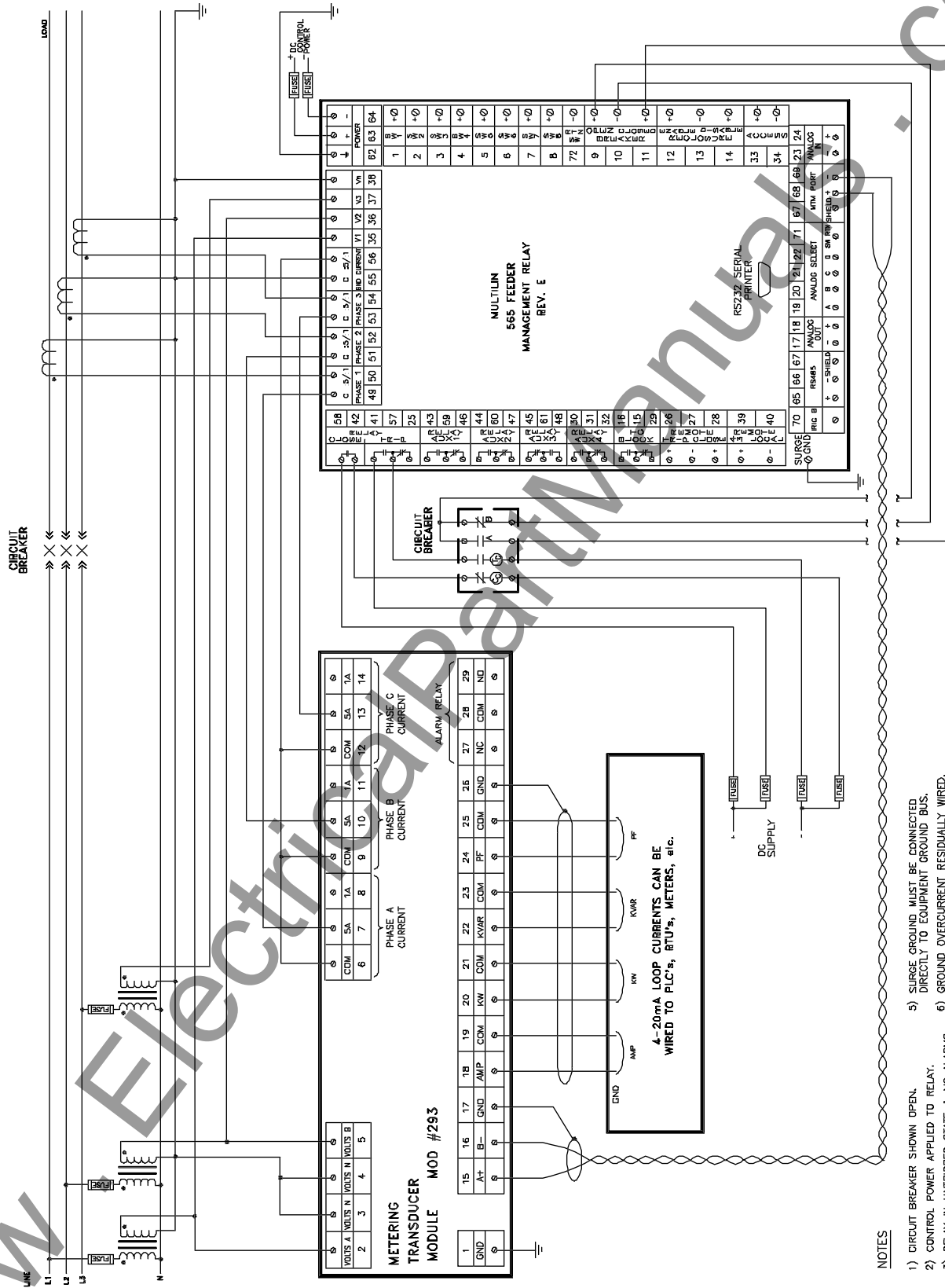
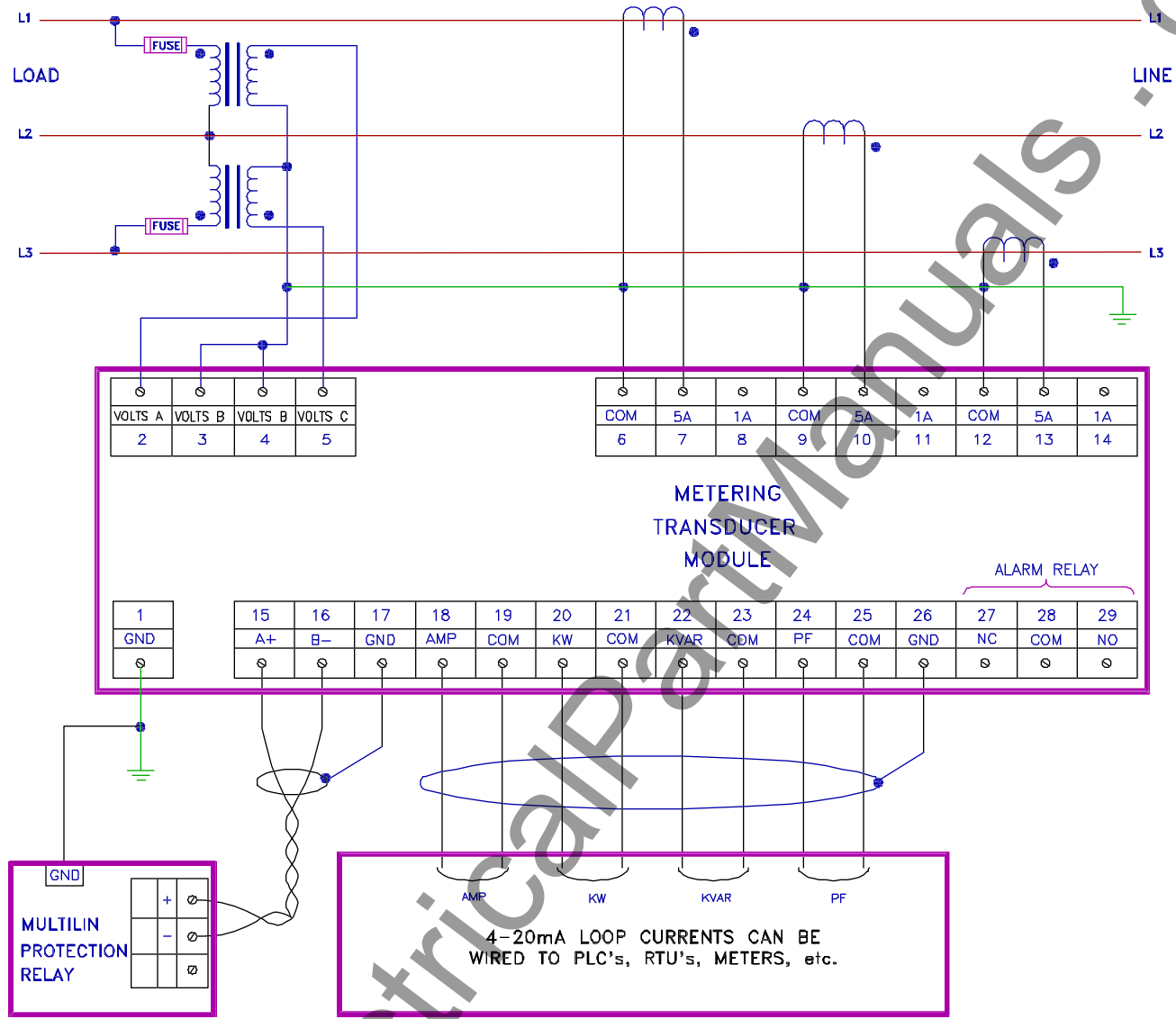

Figure 2.7B 565 with MTM CT and Wye VT Typical Wiring



NOTE:

1. TYPICAL WIRING FOR METERING TRANSFORMERS AND ANALOG OUTPUTS.
2. THE MTM AND PROTECTION RELAY SHOULD BE CONNECTED TO THE SAME GROUNDING TERMINAL.
3. GROUNDING OF CT SECONDARIES SHOULD BE AT ONE LOCATION ONLY.
4. TERMINALS 17 & 26 ARE INTERNALLY GROUND TO TERMINAL 1 AND SHOULD NOT BE EXTERNALLY GROUNDING.
5. SHIELDED WIRE USED FOR RS485 AND ISOLATED ANALOG OUTPUT CONNECTIONS SHOULD BE GROUND AT ONE END ONLY.
6. MULTILIN PROTECTION RELAY REQUIRES CT CONNECTIONS WHEN USED WITH THE MTM.

998033A7

Figure 2.8A Open Delta VT and CT MTM Typical Wiring

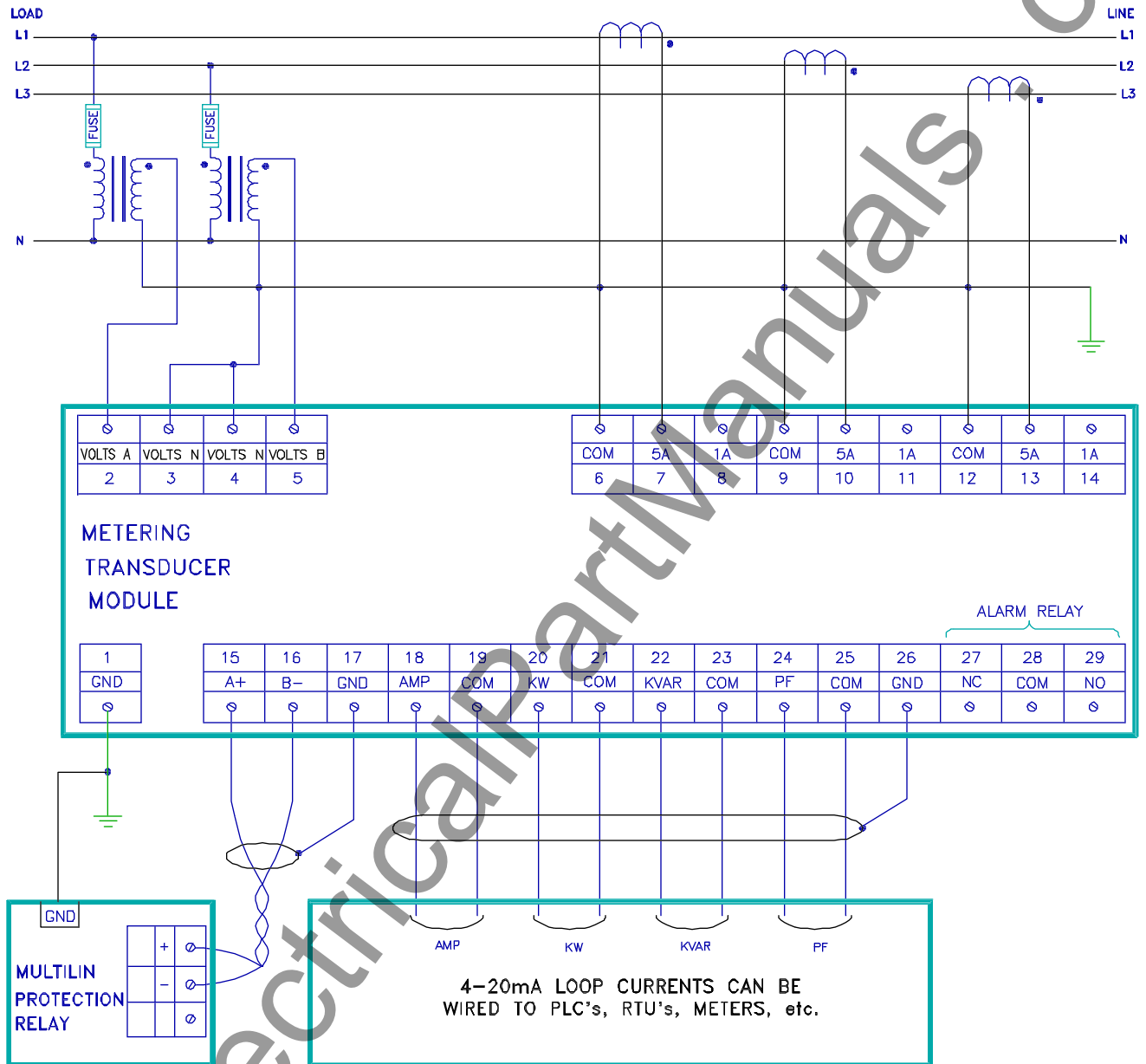

NOTE:

1. TYPICAL WIRING FOR METERING TRANSFORMERS AND ANALOG OUTPUTS.
2. THE MTM AND PROTECTION RELAY SHOULD BE CONNECTED TO THE SAME GROUNDING TERMINAL.
3. GROUNDING OF CT SECONDARIES SHOULD BE AT ONE LOCATION ONLY.
4. TERMINALS 17 & 26 ARE INTERNALLY GROUND TO TERMINAL 1 AND SHOULD NOT BE EXTERNALLY GROUND.
5. SHIELDED WIRE USED FOR RS485 AND ISOLATED ANALOG OUTPUT CONNECTIONS SHOULD BE GROUND AT ONE END ONLY.
6. MULTILIN PROTECTION RELAY REQUIRES CT CONNECTIONS WHEN USED WITH THE MTM.

998040A1.DWG

Figure 2.8B Wye VT and CT MTM Typical Wiring

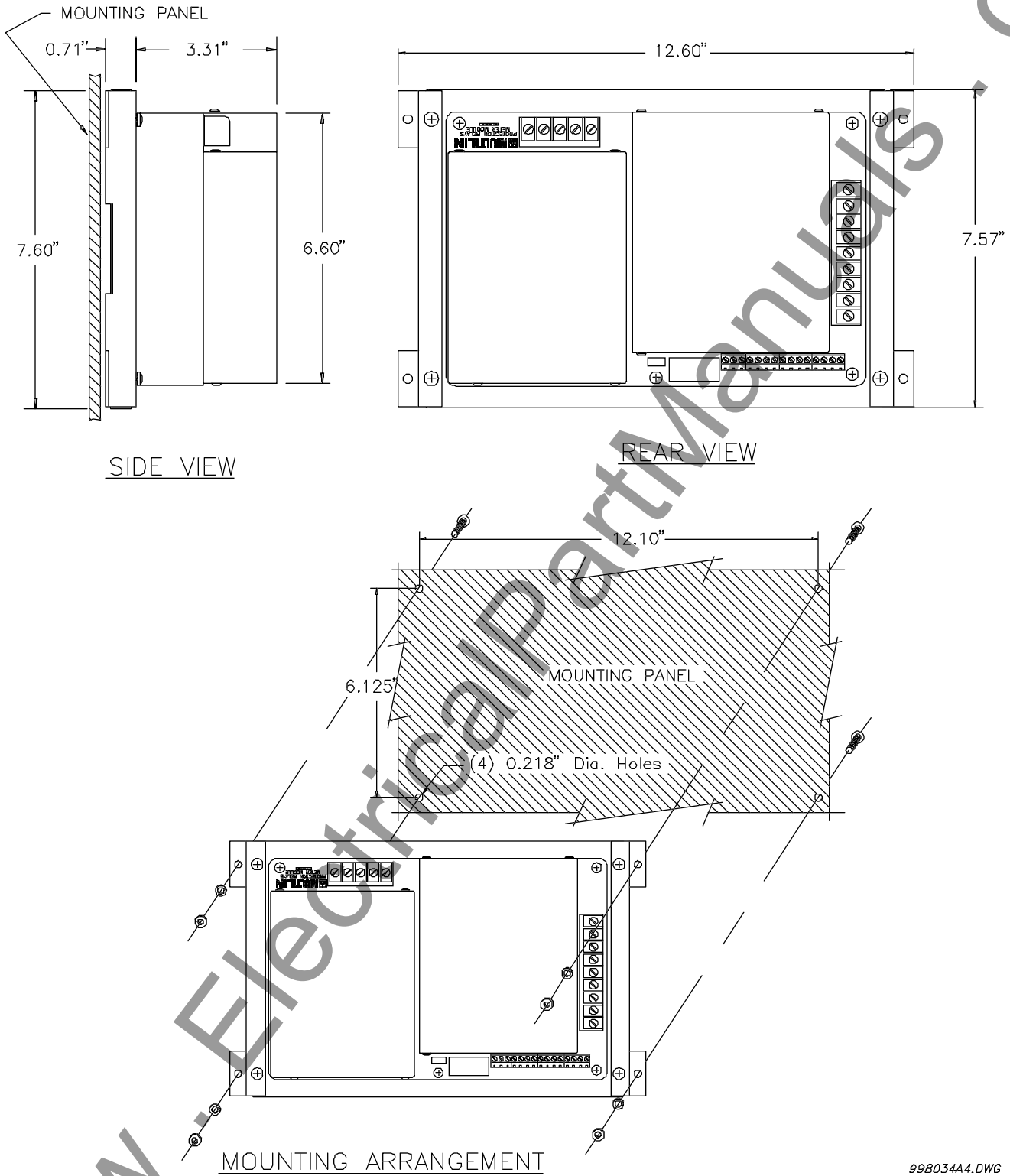

998034A4.DWG

Figure 2.9 MTM Mounting Dimensions

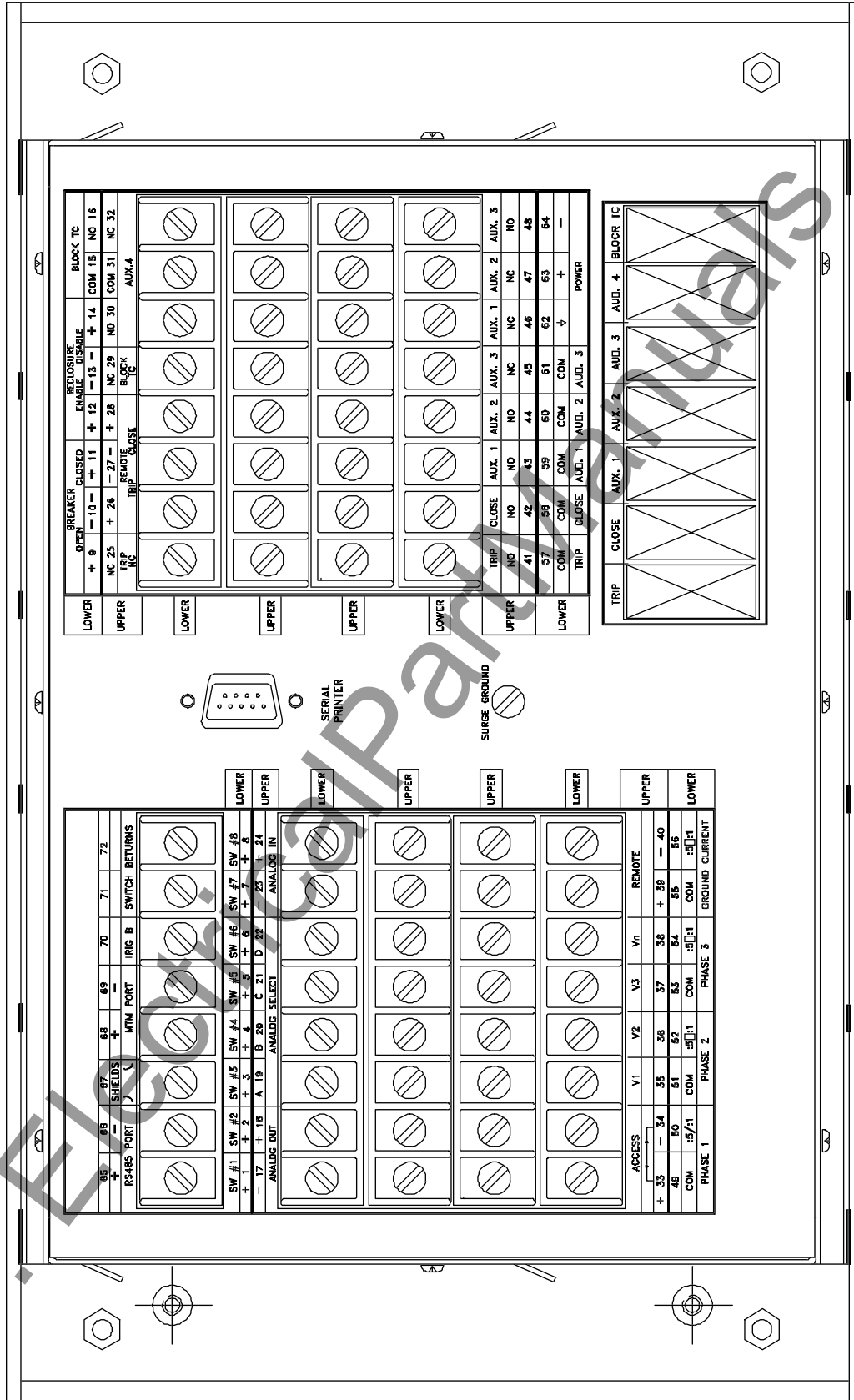

Figure 2.10 565 Rear Panel Layout

www.ElectricalPartManuals.com

Once the electrical connections have been made to the 565/575 Relay and control power is applied, it is ready to be programmed for the particular application. Any key referred to in this section can be located in Figure 4.1, which shows the keypad and front panel. If more information is needed about any key or indicator, refer to the following pages which describe the function and use of these.

Display Modes

The 565/575 Relay is capable of operating in three modes and the display is used for viewing information, in each of these modes. The modes of operation are:

1. Actual Values mode.
2. Setpoints mode.
3. Help mode.

The information in modes 1 and 2 above is laid out in “book” format, that is, each mode has a number of “pages” containing related information. Each page has “lines” containing a message which can be read from the display. The lines are read by entering the required mode by pressing the ACTUAL VALUES, SETPOINTS, or HELP key and using the LINE UP and LINE DOWN keys to view the lines.

Actual Values Mode

In actual values mode, any of the parameters monitored by the 565/575 Relay can be viewed by the user. The message lines in each page of this mode are shown and explained in the Actual Values Mode section of this manual.

When this mode is entered, by pressing the ACTUAL VALUES key, the display will show the following message:

```
ACTUAL VALUES  
CURRENT
```

This is the first line of page one. The remaining lines of page one can be examined by using the LINE DOWN key. When the last line of the page is reached, the PAGE key is used to view the first line of page two. The LINE DOWN key can be used to read each line of the page as before. This can be repeated for all pages in the Actual Values mode. When the last page is reached, pressing the PAGE key will return the display to the first line of page one.

For example, as indicated earlier, the first line of page one shows:

```
ACTUAL VALUES  
CURRENT
```

If the LINE DOWN key is now pressed, the phase A current

can be read from the following message:

```
PHASE A CURRENT  
710 A
```

The LINE DOWN key is then pressed again to view the next message and so on to the last message of the page. When the end of the page is reached, the following message will be displayed:

```
CURRENT  
END OF PAGE
```

The PAGE key can now be pressed to move to the first line of the next page. The display will then show:

```
ACTUAL VALUES  
ANALOG INPUT
```

The PAGE and LINE keys can now be used to view the remaining lines in the Actual Values mode. Refer to the Actual Values section for an explanation of each message.

If the relay is left in actual values mode and no key is pressed for more than four minutes, the display returns to the default line which is setup in actual values mode. The default display will be the display which is visible during normal daily operation of the 565/575 Relay.

Setpoints Mode

This mode is used to view and enter the setpoints of the relay. There are several pages of data, each of which contains different information about the relay's configuration, trip and alarm settings. The lines in each page are shown in the Setpoints Mode section of this manual. To place the relay in setpoints mode, press the SETPOINTS key. The following message will appear:

```
SETPOINTS  
USER LEVEL
```

which is the first line of page one in setpoints mode. The LINE UP and LINE DOWN keys can then be used to view the individual lines in the setpoints mode. For example, if the LINE DOWN key is pressed when the above message is on display, the display changes to:

```
USER LEVEL  
ADVANCED
```

which is the second line of page one of setpoints. When the end of a page is reached, pressing the LINE DOWN key

DISPLAY AND KEYBOARD



causes the following display:

USER LEVEL
END OF PAGE

This message indicates the end of the page and no more lines are available. To move to the first line of the next page, use the PAGE key.

If the relay is left in the setpoints mode with no key being pressed for more than four minutes, the display changes to the default page and line in actual values.

To enter or change setpoints a jumper or access key must first be connected across terminals 33 & 34 and the setpoints mode entered.

If an attempt is made to store a setpoint without enabling the access terminals, the following message will appear:

ILLEGAL ACCESS

and the setpoint will not be stored. This prevents unauthorized changing of setpoints. Stored values remain in the Relay's memory, even when control power is removed. The ability of the relay to provide protection depends on the values entered in the setpoints mode, therefore these values should be complete, accurate and very carefully entered.

Once a setpoint is displayed and the access jumper is installed, it can be changed by either:

1. Entering new numerical values from the Keypad and storing them in the relay's memory using the STORE key, or
2. Making selections from a list of items using the NEXT CHOICE key.

If the selection is to be made using the NEXT CHOICE key then the 565/575 Relay will inform you by flashing the following message on the bottom line of the display:

Use NEXT CHOICE

The possible choices will appear in the display one by one, each time the NEXT CHOICE key is pressed. When the last item in the list is reached pressing the key again will cycle the display through the choices again.

Display the required choice and enter the value into the Relay's memory using the STORE key. The following message will appear for two seconds to indicate that the setpoint has been stored by the Relay.

NEW SETPOINT
STORED

If the STORE key is not pressed the relay will keep the old setpoint regardless of which choice is displayed.

The LINE DOWN key may now be used to move to the next line of the setpoints page and further values entered as described in the Setpoints Mode section.

When the end of a page in setpoints has been reached the PAGE key can be used to view the setpoints on the next page.

Help Mode

This display mode should be used whenever help is required in using the 565 relay. It is entered by pressing the HELP key while the display is on any line in any page. The HELP key can provide information about the currently displayed actual value or setpoint message. Pressing the HELP key has no effect when a flash message or HELP message is on the display.

If the HELP key is pressed with the display on the first line of page one the following message will appear:

PRESS ANY KEY
OR HELP

The user should then press the key for which instruction is required or press the HELP key again to access information on the previously displayed actual value or setpoint message. When the desired key is pressed the display will show the message:

PRESS LINE DOWN
TO SCROLL

The LINE DOWN key can then be used to display the HELP message which will give information about the line or key in question.

If the HELP key is pressed while displaying any line other than a page header the HELP message shown will relate to the line which was displayed when the HELP key was pressed. This applies when the 565/575 Relay is in actual values or setpoints.

Pressing the CLEAR key at any time during the help message will return the display to the page and line of the mode in effect when the HELP key was originally pressed. The ACTUALVALUES and SETPOINTS keys may also be pressed to exit HELP mode.

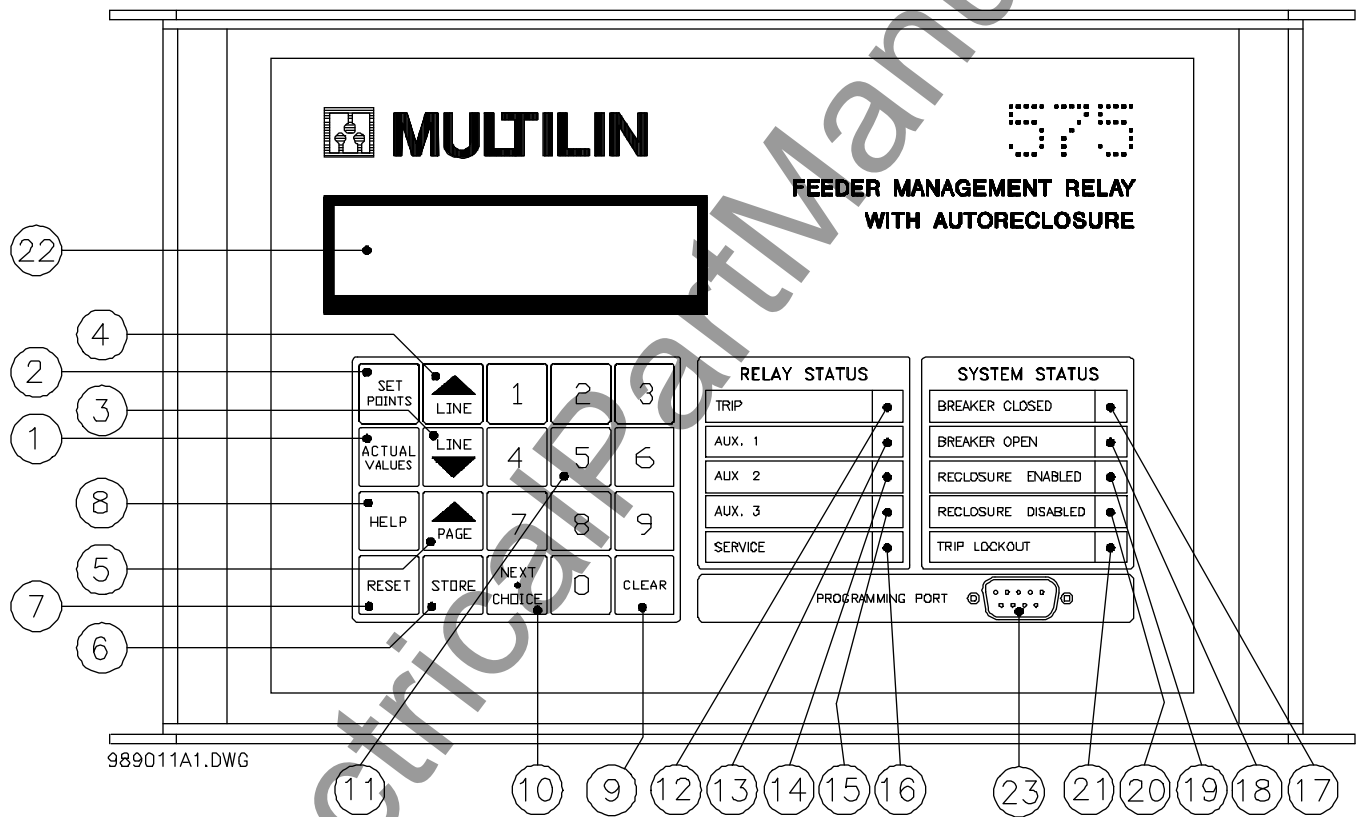
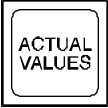

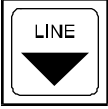







Figure 4.1 565 Relay Front Panel

DISPLAY AND KEYBOARD



This section describes the front panel controls and indications. The "No." column gives the number of each of the keys and indications shown in Figure 4.1. The "Name" column shows the name of the key or indicator in question and the description column gives information about the use of the key or indicator.

Number	Name	Description
1		<p>The ACTUAL VALUES key allows the user to examine all the information in the pages of actual values described in the ACTUAL VALUES MODE section. Pressing this key causes the following message to appear, which indicates the first line of page one of the Actual Values mode:</p> <div data-bbox="380 478 779 573" style="border: 1px solid black; padding: 5px; text-align: center;">ACTUAL VALUES CURRENT</div>
2		<p>The SETPOINTS key allows the user to examine and change all the user-programmable setpoints in the pages of setpoint data as described in the SETPOINTS MODE section. Pressing this key will cause this message to appear, also indicating the first line of page one of the Setpoints mode:</p> <div data-bbox="380 718 779 812" style="border: 1px solid black; padding: 5px; text-align: center;">SETPOINTS USER LEVEL</div>
3,4	 	<p>These keys allow the user to view the previous or next line of the current page, as indicated by the arrow pointing up or down respectively. If either key is held pressed for more than two seconds then the next or previous lines will be displayed at a fast rate. If the display already shows the last line of any page then pressing the LINE DOWN key will cause the following message to be displayed:</p> <div data-bbox="380 989 779 1083" style="border: 1px solid black; padding: 5px; text-align: center;">END OF PAGE</div>
5		<p>The PAGE key allows the user to move from any line in a page to the first line in the next page. For example, if you are currently viewing any line in page 2 of the Actual Values mode, pressing this key will cause the display to move to the first line of page 3, Actual Values. If this key is pressed on the last page of either Actual Values or Setpoints then the display will move to the first page of that section. As with the LINE keys, holding down the PAGE key will cause the pages to be displayed rapidly.</p>
6		<p>The STORE key is used to store all new setpoints in the 565/575 Relay's memory. When this key is pressed, the value being displayed will be stored as a new setpoint in the relay's memory and the following message will appear for 2 seconds (provided the Access jumper is installed):</p> <div data-bbox="380 1430 779 1524" style="border: 1px solid black; padding: 5px; text-align: center;">NEW SETPOINT STORED</div>
		<p>The numeric keypad or the NEXT CHOICE keys are used to display the correct value as seen later. The STORE key can only be used to store data within the ranges accepted by the 565/575 Relay. It is also used to set the default display in actual values as described in the Actual Values Mode section of this manual.</p>
7		<p>The RESET key returns the trip or any latched output relay to its inactive state and extinguishes the associated LED after a fault condition has caused it to become active. This key will only be effective if the fault condition has been removed. Otherwise, resetting will not be possible and pressing the key will result in one the following messages:</p> <div data-bbox="380 1839 779 1934" style="border: 1px solid black; padding: 5px; text-align: center;">RESET IMPOSSIBLE FAULT PRESENT</div>

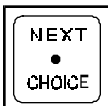
Number	Name	Description
		<div style="border: 1px solid black; padding: 5px; text-align: center;"> RESET IMPOSSIBLE ALARM PRESENT </div>
8		<p>The HELP key provides the user with information on the function and use of each key on the keypad. It also provides information about the currently displayed actual values or setpoints message. If information is needed on the use of any of the keys on the keypad, use the LINE UP or PAGE key to display the first line of any page. Then press the HELP key and the following message will appear:</p>
		<div style="border: 1px solid black; padding: 5px; text-align: center;"> PRESS ANY KEY OR HELP </div>
		<p>The user should then press the key for which instruction is required, for example, the PAGE key. If information is needed on the previously displayed actual values or setpoints message, press HELP again.</p>
		<p>The HELP key can also be pressed on any line of either setpoints or actual values to get information on that particular setpoint or actual value. If this is done the following message will appear:</p>
		<div style="border: 1px solid black; padding: 5px; text-align: center;"> PRESS LINE DOWN TO SCROLL </div>
		<p>Pressing LINE DOWN will allow the help message to be viewed. Pressing CLEAR will return the display to the line where help was requested. Continue pressing LINE DOWN to display the entire help message.</p>
9		<p>The CLEAR key performs two functions.</p>
		<ol style="list-style-type: none"> 1. In the setpoints mode, pressing this key will return an altered unstored setpoint to its original value. This might be used if you keyed in an incorrect value and had not yet stored it. Once a value is stored it cannot be altered using the CLEAR key. 2. In the Help mode the key allows the user to return to the previous display mode as described in number 8.
10		<p>This key, which also functions as the decimal point key is used to view a list of items which cannot be shown on the display at once. Pressing the NEXT CHOICE key once will cause the first item from the list to be displayed, pressing it again will display the second item, and so on. When the last item is reached pressing the key will cause the first item to be displayed again. The entire list can thus be viewed as many times as needed. The following example shows the use of the NEXT CHOICE key.</p>
		<p>For example, in Setpoints Mode page 3, the ground protection curve is chosen from a list of 5 curves. When this line is first read it will display the curve in use, the Extremely Inverse curve being shown below.</p>
		<div style="border: 1px solid black; padding: 5px; text-align: center;"> GND O/C CURVE SHAPE: EXTREM INV </div>
		<p>To advise the user that the NEXT CHOICE key may be used to display other curves, the bottom line of this display will change for two seconds, and the following display will be seen:</p>

DISPLAY AND KEYBOARD



Number	Name	Description
--------	------	-------------

GND O/C CURVE Use NEXT CHOICE

The display will then return to displaying the Extremely Inverse curve. The other curves can now be viewed one at a time by pressing the NEXT CHOICE key. For example, the Custom Curve will be seen the next time the key is pressed as shown in the following display.

GND O/C CURVE SHAPE : CUSTOM

The remaining curves can be viewed in the same way. The display will cycle through all the curves as the key is pressed. Note that the curve in use by the 565/575 Relay will not be changed by displaying the various choices. To change the curve in use, it must be displayed and stored. See the STORE key description.

11		The Numeric keypad has the numbers 0 to 9 and the decimal point. These keys are used to enter the numerical values of the various setpoints with or without a decimal. The decimal point key also functions as the NEXT CHOICE key. In this case it is used to display one choice at a time from a list of items. See NEXT CHOICE key description.
----	---	--

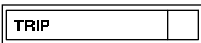
12		The Trip LED indicates the state of the trip output relay which is used to trip the Feeder Breaker monitored by the 565/575 Relay. When the LED is on, the Trip relay is active with the cause of the trip condition shown on the LCD display. A flashing LED indicates that the relay was active, and has returned to its inactive state. This can occur when the fault condition disappears and the relay is programmed as pulsed. The LED will be extinguished by pressing the RESET key only if the fault condition causing the relay to be activated has been removed.
----	---	---

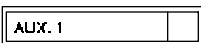
13		The Aux 1 LED indicates the state of the output relay, Aux 1, which can be used for a function chosen by the user. When the LED is on, the relay is active. If pulsed or unlatched operation is chosen for this relay, the LED will flash if a trip condition is removed or will be extinguished when the condition causing an alarm is removed. If latched operation is chosen the RESET key must be pressed to return the relay to its no fault state and extinguish the LED indicator.
----	---	---

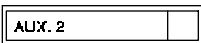
14		The Aux 2 LED indicates the state of the output relay, Aux 2, which can be used for a function chosen by the user. When the LED is on, the relay is active. If pulsed or unlatched operation is chosen for this relay, the LED will flash if a trip condition is removed or will be extinguished when the condition causing an alarm is removed. If latched operation is chosen the RESET key must be pressed to return the relay to its no fault state and extinguish the LED indicator.
----	---	---

15		The Aux.3 LED indicates the state of the output relay, Aux.3. When the LED is on, as during a trip coil supervision alarm, the Aux 3 relay is inactive (cold coil).
----	---	---

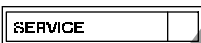
16		If the Service LED illuminates steadily, the supply voltage may be too low. This LED may come on momentarily when the 565/575 Relay is powered up. This is normal and does not indicate a fault condition.
----	---	--

17		The Breaker Closed LED indicates the status of the Feeder Breaker being monitored by the 565/575 Relay. The LED is on if the Feeder Breaker is closed.
----	---	--

18		The Breaker Open LED indicates the status of the Feeder Breaker being monitored by the 565/575 Relay. The LED is on if the Feeder Breaker is open.
----	---	--

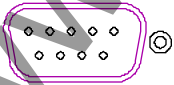
19		RS232 program port. This port allows for programming from a personal computer. When a cable is connected to this port and the DTR line is pulled high, the rear RS485 communications port is disabled.
----	---	--

Number	Name	Description
20		The display is a 32 character alphanumeric type. This display visually shows in English all values, setpoints, and messages, through a series of lines within the pages of 3 display modes: Actual Values, Setpoints, and Help.

www.ElectricalPartManuals.com

www.ElectricalPartManuals.com

All the messages displayed by the 565/575 Relay in the actual values mode are listed and explained in this section. As already seen, the messages are laid out in book form with pages containing lines, each of which displays one message. The 565/575 Relay has two user levels, "basic" and "advanced". The messages seen depend on this user level, which is chosen in page one of setpoints. The basic level allows the user to operate the relay using the minimum of the features necessary. The advanced level allows the user to use all the 565/575 Relay features.

The advanced user sees all the messages shown. The messages which will only be seen by the advanced user and not the basic user are marked "L_A", for "Level-advanced".

The actual value mode has pages with the following information:

Page Contents

1. Current data.
2. Analog Input data.
3. Maintenance data.
4. Operations data.
5. Pretrip data.
6. Voltage and Frequency related data.
7. Event-Recording data.
8. Amps Demand Metering data.
9. MTM Metering data.

The numbers in the "Location" column to the left of each message in this section give the page and line of that message in the 565/575 Relay's memory. For example, the message to the right of A 1.3 in the "Location" column will appear on page 1 and line 3 when the Relay is in actual values Mode and is referred to as "message A 1.3". If the letters "L_A" appear below a message in this column, this indicates that the message will only appear if the advanced user level is selected. The message will not appear if the basic user level is selected.

The "Message Line" column shows the actual message which can be read from the LCD display on the front panel of the unit.

Quantities shown in display boxes are typical values only. Different quantities will be displayed in each particular application.

Note: When finished viewing a message, press the LINE DOWN key to view the next line. When the last line of a page is reached, press the PAGE key to view the first line of the next page.

When the last line of the last page in actual values is reached, pressing the PAGE key will return the display to the first page again.

Default Message Selection

The default message is the message which will be displayed by the Relay under normal operating conditions. The display will show the selected message if no key on the keypad is pressed for more than four minutes and no alarm or trip condition is present. Any message in actual values except page headers, end of page markers, and messages A 3.2, A 3.7, A 4.9, A 7.4, A 7.9, A 7.10, A 8.6, A 8.10 and A 8.14 may be selected as the default message. The above messages cannot be used as their function is to allow data to be entered into the Relay. To select any other message as the default message, proceed as follows:

Use the PAGE key to select the page on which the required message is located, in actual values, and use the LINE DOWN key to display the message. Pressing the STORE key will cause the following message to be displayed:

NEW DEFAULT
LINE SELECTED

The message selected is now the new default message.

Actual Values Message Abbreviations.

The following abbreviations are used in the actual values messages:

A	Amperes.
AC	Access.
BRKR	Breaker.
CL'D	Cleared.
DEG C	Degrees Celsius.
DEM'D	Demand.
Hz	Hertz.
INS	Installed.
INST	Instantaneous.
KA	Kiloamps.
kVAR	Kilovars.
kV	Kilovolts.
kW	Kilowatts.
MTM	Metering Transducer Module.
MWHR	Megawatt Hours.
No.	Number.
O/C	Overcurrent.
PH	Phase.
TEMP	Temperature.
TRANS	Transformer.
WNDG	Winding.

ACTUAL VALUES MODE



Summary of Actual Value Page Contents

Page	Contents	Page	Contents
1.	Current Data. Phase currents Ground currents	8.	Demand Metering Data. Peak demand amps Peak KW demand Peak KVAR demand
2.	Analog Input Data. Analog input scaled values	9.	Metering Data. Power factor MTM frequency kW kVAR MWhrs
3.	Maintenance Data. Breaker date Breaker trips Accumulated KA		
4.	Operations Data. Timed phase overcurrent trips Instantaneous phase overcurrent trips Timed ground overcurrent trips Inst. ground overcurrent trips Overvoltage trips Undervoltage trips Analog input trips		
5.	Pretrip Data. Cause of present alarm Cause of last trip Phase trip current Ground trip current Phase trip voltage Frequency at trip Date of trip Time of trip		
6.	Voltage Data. Phase voltage Frequency of feeder		
7.	Event Recording Data. No. of events View events Events Print events Clear events		

Location	Message Line	Description
A 1.1	ACTUAL VALUES CURRENT	The actual values page 1 header. This page gives information on the feeder phase and ground currents being monitored by the 565 Relay.
A 1.2	PHASE A CURRENT 710 A	This is the actual monitored RMS current flowing in phase A of the feeder.
A 1.3	PHASE B CURRENT 715 A	This is the actual monitored RMS current flowing in phase B of the feeder..
A 1.4	PHASE C CURRENT 710 A	This is the actual monitored RMS current flowing in phase C of the feeder.
<i>Message A 1.5 will only appear if Ground Sensing has been enabled in setpoints.</i>		
A 1.5	GROUND CURRENT 10 A	This is the actual leakage current flowing to ground in the system.
A 1.6	PHASES A= 710 B= 715 C= 710	This message allows all three phase currents to be displayed if they are greater than 2% CT.
	PHASES A<2% CT B<2% CT C<2% CT	When the breaker is closed and the current is less than 2% of CT, the three phase display will reflect this with "<2% CT".
A 1.7	CURRENT END OF PAGE	The last line of page 1, actual values. Press the PAGE key to view page 2.

ACTUAL VALUES MODE - ANALOG INPUT



Location	Message Line	Description
A 2.1	<pre>ACTUAL VALUES ANALOG INPUT</pre>	The actual values page 2 header. The 565/575 Relay can accept an analog signal from 4 to 20 mA from any device such as a temperature monitor, and provide trip or alarm signals at a user programmed value. The value of this temperature, for example, is displayed in this page in whatever units you select in the setpoints mode. Degrees Celsius are shown.
<i>Message A 2.2 will only appear if Analog-In has been disabled in setpoints.</i>		
A 2.2	<pre>ANALOG INPUT DISABLED</pre>	If Analog-In has been disabled in setpoints, this will be the only message displayed.
<i>Message A 2.3 will only appear if Analog In has been enabled in setpoints.</i>		
A 2.3 L _A	<pre>TRANS WNDG TEMP 87 DEG C</pre>	This is the present value of the analog signal being monitored by the Relay, if this option is used. In this example, the temperature of a transformer winding is being monitored and degrees Celsius units have been chosen. Other names and units can be selected, in setpoints mode.
A 2.4	<pre>ANALOG INPUT END OF PAGE</pre>	The last line of page 2. Press the PAGE key to view page 3.

Location	Message Line	Description
A 3.1	ACTUAL VALUES MAINTENANCE DATA	The actual values page 3 header. This page allows the maintenance related data, which the Relay has collected, to be viewed. This data remains in memory even if the control power is removed from the Relay. Information on the number of breaker trips and accumulated breaker trip current is stored on this page for use in scheduling breaker maintenance.
A 3.2	BRKR mm/dd/yy DATE AUG 23,1988	The new breaker in service date is entered here in the form: Month:Day:Year. For example, if August 04, 1992 was the date then the following would be entered: 08:04:92
A 3.3 L _A	BREAKER TRIPS 79	This is the total number of times that the feeder circuit breaker controlled by the Relay has been tripped since the breaker was put in service. The maximum number of trips displayable is 10000. If the maximum number of trips exceeds 10000, *** will be displayed. This figure may be useful for scheduling mechanical inspections of the breaker.
A 3.4	ACCUMULATED KA PHASE A 566	This is the square of the Kiloamps feeder current measured right at the time that the breaker delay rating has elapsed and the breaker is open. This measurement is made at each trip of the breaker and added to the previous accumulated value. This accumulated value gives an indication of breaker pole wear and can be used to schedule inspections.
A 3.5	ACCUMULATED KA PHASE B 568	This is the accumulated sum of the Kiloamps squared phase B current.
A 3.6	ACCUMULATED KA PHASE C 765	This is the accumulated sum of the Kiloamps squared phase C current.
A 3.7	MAINTENANCE DATA CLEAR? NO	This message asks if you want to clear the maintenance data which has been collected to date. Use the NEXT CHOICE key to display YES or NO and then store the value.
A 3.8	DATA CLEARED LAST:AUG 04,1992	This is the date on which the maintenance data was last cleared in message A 3.7. This date is automatically entered by the Relay, when the data is cleared. All the maintenance data in this page has been collected from the date shown here.
A 3.9	MAINTENANCE DATA END OF PAGE	The last line of page 3, actual values. Press the PAGE key to view page 4.

ACTUAL VALUES MODE - OPERATIONS DATA



Location	Message Line	Description
A 4.1	ACTUAL VALUES OPERATIONS DATA	The actual values page 4 header. This page allows the feeder operation related data, which the Relay has collected, to be viewed. Information on the number and types of trips issued by the Relay can be viewed in this page. This data remains in memory even if the control power is removed from the 565/575 Relay. The maximum number of trips which can be displayed is 10,000. If the maximum number of trips exceeds 10,000, *** will be displayed.
A 4.2	TIMED PHASE O/C TRIPS 23	This is the number of times that the feeder breaker controlled by the 565/575 Relay has been tripped due to the current flowing through it exceeding the timed phase overcurrent level set up in the setpoints mode.
A 4.3	INST PHASE O/C TRIPS 5	This is the number of times that the feeder breaker has been tripped by the Relay due to the current in the three phase system exceeding the phase instantaneous limits set up in the setpoints mode.
A 4.4	TIMED GROUND O/C TRIPS 45	This is the number of times that the feeder breaker has been tripped by the Relay due to ground current in the three phase system exceeding the programmed level set up in the setpoints mode.
A 4.5	INST GROUND O/C TRIPS 6	This is the number of times that the feeder breaker has been tripped by the 565 Relay due to the ground current exceeding the instantaneous limits set up in the setpoints mode.
<i>Messages A 4.6 and A 4.7 will only be shown if the Voltage feature has been enabled in Setpoints.</i>		
A 4.6	OVERVOLTAGE TRIPS 3	This is the number of times that the feeder breaker has been tripped by the Relay due to an overvoltage exceeding the programmed level set up in setpoints mode.
A 4.7	UNDERVOLTAGE TRIPS 3	This is the number of times that the feeder breaker has been tripped by the Relay due to an undervoltage exceeding the programmed level set up in setpoints mode.
A 4.8	ANALOG INPUT TRIPS 3	This is the number of times that the feeder breaker has been tripped by the Relay due to analog input exceeding the programmed level set up in setpoints mode.
A 4.9	CLEAR OPERATIONS DATA? NO	This message allows the user to clear the data in messages A 4.2 to 4.8. To clear the data use the NEXT CHOICE key to select YES and then press the STORE key. YES should only be selected if you are prepared to lose the old data. The new data will be collected from the date that the clearing was done. Select NO to continue using the old data.
A 4.10	DATA CLEARED LAST: AUG 04, 1992	This is the date when the operations data was last cleared in message A 4.9. This date is automatically entered by the Relay when the data is cleared. This message can be referred to at any time to check the date that the present data collecting originated.
A 4.11	OPERATIONS DATA END OF PAGE	The last line of page 4, actual values. Press the PAGE key to view page 5.

Location	Message Line	Description
A 5.1	ACTUAL VALUES PRE-TRIP DATA	The actual values page 5 header. This page displays the cause of the current alarm and the cause of the last trip. It also gives data on the condition of the feeder when a trip was last initiated by the 565/575 Relay. This page can be viewed immediately after an alarm or trip to determine its cause. Also, if an overcurrent trip has occurred, then the phase currents can be inspected to check which phase or phases caused this.
A 5.2	ALARM: PHASE O/C	This message will only appear if the condition causing the alarm is present. In this case the current in any or all of the phases is exceeding the phase alarm limit set up in setpoints mode.
	ALARM: GROUND O/C	This message indicates that the present alarm is caused by the ground current exceeding the limits specified in setpoints mode.
	ALARM: OVERVOLT	This message indicates that the present alarm is caused by the voltage sensed between phases or between a phase and the neutral line rose above the limits specified in setpoints mode.
	ALARM: UNDERVOLT	This message indicates that the present alarm is caused by the voltage sensed between phases or between a phase and the neutral line dropped below the limits specified in setpoints mode.
	ALARM: ANALOG INPUT	This message indicates that the present alarm is caused by the analog input exceeding the limits specified in setpoints mode.
	ALARM: ACCUMULATED KA	This message indicates that the present alarm is caused by the Accumulated KA exceeding the limits specified in setpoints mode.
	SWITCH ALARM 1	This message indicates that the present alarm is caused by the external switch programmed to create a Definite Time alarm.
	ALARM: AMPS DEMAND	This message indicates that the present alarm is caused by the Amps Demand exceeding the limits specified in setpoints mode.
	ALARM: KW DEMAND	This message indicates that the present alarm is caused by the kW Demand exceeding the limits specified in setpoints mode. ** 565 requires Option Card **
	ALARM: KVAR DEMAND	This message indicates that the present alarm is caused by the kVAR Demand exceeding the limits specified in setpoints mode. ** 565 requires Option Card **
	ALARM: POWER FACTOR	This message indicates that the present alarm is caused by the MTM Power Factor exceeding the limits specified in setpoints mode. ** 565 requires Option Card **
	ALARM: FREQUENCY	This message indicates that the present alarm is caused by the MTM Frequency exceeding the limits specified in setpoints mode. ** 565 requires Option Card **
	ALARM: BREAKER DISCREPANCY	This message indicates that the present alarm is caused by the feeder breaker not responding within the time limit specified in setpoints mode.

ACTUAL VALUES MODE - PRE-TRIP DATA



Location	Message Line	Description
	ALARM: TRIP COIL	This message indicates that the present alarm is caused by an open in the trip coil circuit. ** 565 requires Option Card **
	ALARM: MTM COMM	This message indicates that the present alarm is caused by failure in MTM communications. ** 565 requires Option Card **
A 5.3	CAUSE OF LAST TRIP:	This message appears on the display for 2 seconds to advise the user that the cause of the last trip will be displayed next. It will then disappear to be replaced by the next message which will give the reason for the last trip of the feeder breaker. One of the following messages will then be displayed.
A 5.4	TIME OVERCURRENT PHASE A B C	This message indicates that the feeder breaker trip was caused by the current in any or all of the phases A, B or C of the feeder exceeding the phase time/overcurrent limits programmed in the setpoints mode. Phases A, B and C are shown here.
	TIME OVERCURRENT GROUND	This message indicates that the trip was caused by the ground current sensed by the 565 Relay exceeding the limits set by the timed/overcurrent curve which was programmed in the setpoints mode.
	INST OVERCURRENT PHASE B	This message indicates that the trip was caused by the current in any or all of the phases A, B or C exceeding the instantaneous limit set up in setpoints mode. Phase B is shown here.
	INST OVERCURRENT GROUND	This message indicates that the feeder breaker was tripped due to the ground current exceeding the instantaneous setpoint entered in setpoints mode.
	UNDERVOLTAGE FAULT	This message indicates that the voltage sensed between phases or between a phase and the neutral line dropped below the undervoltage limits set in setpoints mode, causing a feeder breaker trip.
	OVERVOLTAGE FAULT	This message indicates that the voltage sensed between phases or between a phase and the neutral line rose above the overvoltage limits set in setpoints mode, causing a feeder breaker trip.
	EXTERNAL TRIP #1 SWITCH 3	This message indicates which of four external trips, indicated by the switch named, caused the breaker to trip. There are eight user programmable switches named SW.1 to SW.8. Each of these may be assigned to one external trip.
	ANALOG INPUT TRANS WNDG TEMP	This display indicates that the trip was caused by the analog input to the 565 Relay exceeding the limits specified in setpoints mode. If a name was assigned to this analog input in setpoints mode, then this name will appear in the message. A typical user-assigned name, "TRANS WNDG TEMP" indicating a transformer winding temperature is shown for example.
	POWER FACTOR FAULT	This message indicates that the trip was caused by the MTM power factor exceeding the limits specified in the setpoints mode. ** 565 requires Option Card **
	FREQUENCY FAULT	This message indicates that the trip was caused by the MTM frequency exceeding the limits specified in the setpoints mode. ** 565 requires Option Card **

Location	Message Line	Description
A 5.5	PHASE A PRE-TRIP CURRENT 16100 A	This is the RMS current flowing in phase A measured over one cycle of feeder current, at the time that the 565/575 Relay initiated the breaker trip.
A 5.6	PHASE B PRE-TRIP CURRENT 15900 A	This is the RMS current flowing in phase B measured over one cycle of feeder current, at the time that the 565/575 Relay initiated the breaker trip.
A 5.7	PHASE C PRE-TRIP CURRENT 16200 A	This is the RMS current flowing in phase C measured over one cycle of feeder current, at the time that the 565/575 Relay initiated the breaker trip.
A 5.8	GROUND PRE-TRIP CURRENT 250 A	This is the RMS ground current sensed by the Relay measured over one cycle of feeder current, at the time when the 565/575 Relay initiated the breaker trip.

Messages A 5.9 to 5.11 will only appear if an Open Delta system is chosen in Setpoints mode.

A 5.9	PRE-TRIP VOLTAGE A-B 13.80 kV	This is the voltage between phases A and B when the 565 Relay caused the feeder breaker to trip due to a system fault.
A 5.10	PRE-TRIP VOLTAGE B-C 13.80 kV	This is the voltage between phases B and C when the 565/575 Relay caused the feeder breaker to trip due to a system fault.
A 5.11	PRE-TRIP VOLTAGE C-A 13.80 kV	This is the voltage between phases C and A when the 565/575 Relay caused the feeder breaker to trip due to a system fault.

Messages A 5.12 to 5.14 will only appear if a Wye system is chosen in Setpoints mode.

A 5.12	PRE-TRIP VOLTAGE A-N 7.85 kV	This is the voltage between phase A and the neutral line when the 565/575 Relay caused the feeder breaker to trip due to a system fault.
A 5.13	PRE-TRIP VOLTAGE B-N 7.85 kV	This is the voltage between phase B and the neutral line when the 565/575 Relay caused the feeder breaker to trip due to a system fault.
A 5.14	PRE-TRIP VOLTAGE C-N 7.85 kV	This is the voltage between phase C and the neutral line when the 565/575 Relay caused the feeder breaker to trip due to a system fault.
A 5.15 L _A	FREQUENCY AT TRIP 60.2 Hz	This is the feeder frequency, measured in Hz, at the time when the 565/575 Relay caused the breaker to trip. If an MTM is communicating with the 565/575 at the time of the trip, the frequency recorded will be from the MTM.
A 5.16	DATE OF TRIP AUG 04,1992	This is the date when the 565/575 Relay last tripped the feeder breaker due to a system fault.
A 5.17	TIME OF TRIP 14:20:42	This is the time when the 565/575 Relay last tripped the feeder breaker. It is laid out in the following form: Hour:Minute:Second

ACTUAL VALUES MODE - PRE-TRIP DATA



Location	Message Line	Description
A 5.18	PRE-TRIP DATA END OF PAGE	The last line of page 5, actual values. Press the PAGE key to view page 6.

www.ElectricalPartManuals.com

Location	Message Line	Description
----------	--------------	-------------

Messages A 6.1 to 6.9 will only appear if voltage sensing has been enabled in setpoints mode.

A 6.1	ACTUAL VALUES VOLTAGE	The actual values page 6 header. This page gives values of the voltage and frequency of the three phase feeder being monitored by the 565/575 Relay.
-------	--------------------------	--

Messages A 6.2 to 6.4 will only appear if an Open Delta system is chosen in Setpoints mode.

A 6.2	VOLTAGE A-B 4.16 kV	The voltage between phases A and B of the feeder being monitored by the 565/575 Relay.
-------	------------------------	--

A 6.3	VOLTAGE B-C 4.16 kV	The voltage between phases B and C of the feeder being monitored by the 565/575 Relay.
-------	------------------------	--

A 6.4	VOLTAGE C-A 4.16 kV	The voltage between phases C and A of the feeder being monitored by the 565/575 Relay.
-------	------------------------	--

Messages A 6.5 to 6.7 will only appear if a Wye system is chosen in setpoints mode.

A 6.5	VOLTAGE A-N 2.30 kV	The voltage between phase A and the neutral line of the feeder being monitored by the 565/575 Relay.
-------	------------------------	--

A 6.6	VOLTAGE B-N 2.30 kV	The voltage between phase B and the neutral line of the feeder being monitored by the 565/575 Relay.
-------	------------------------	--

A 6.7	VOLTAGE C-N 2.30 kV	The voltage between phase C and the neutral line of the feeder being monitored by the 565/575 Relay.
-------	------------------------	--

The following message will be displayed if no Metering Transducer Module (MTM) has been connected. If a MTM is used and an Option Card is installed, see METERING DATA page in Actual Values for frequency reading.

A 6.8	FREQUENCY OF FEEDER 60.1 Hz	This is the frequency of the feeder voltage being monitored by the 565/575 Relay. The frequency measurements are also enhanced. They are accurate to better than 0.1% of nominal frequency (0.05 Hz). Displayed data resolution is now 0.01 Hz.
-------	--------------------------------	---

A 6.9	VOLTAGE END OF PAGE	The last line of page 6, actual values. Press the PAGE key to view page 7.
-------	------------------------	--

ACTUAL VALUES MODE - EVENT



Location	Message Line	Description
A 7.1	ACTUAL VALUES EVENT	The Actual Values page 7 header. This page allows the recorded events to be viewed. * NOTE: See Section 7 for more information on Event Recording.
<i>Message A 7.2 will only appear if event recording has been disabled in setpoints.</i>		
A 7.2	EVENT RECORDING DISABLED	This message is used to inform the user that event recording has been disabled.
<i>Messages A 7.3 to A 7.11 will only appear if event recording has been enabled in the setpoints mode.</i>		
A 7.3	NO. OF EVENTS : XX	This message shows the number of recorded events.
A 7.4	VIEW EVENTS? NO	This message asks if the user wants to view events. Use the NEXT CHOICE key to display YES or NO and press STORE to select the choice. If YES is selected, the event template will appear for 2 seconds. Following this, the first event will be displayed. Viewing of Event Recorder data is in natural order — last event is first viewed.
A 7.5	## EVENT CAUSE t mm/dd/yy hh:mm	Event template: The top line shows the event number and the cause of event fields. The second line shows the event type, date and time fields.
A 7.6	01 PH-A TIME O/C T 04/19/90 22:30	This message shows an example of a trip event - Phase A Timed Overcurrent Trip, occurred at 10:30pm on April 19, 1990. Press LINE DOWN key to display the next event.
A 7.7	02 UNDERVOLTAGE A 04/19/90 22:31	This message shows an example of an alarm event - Undervoltage Alarm.
A 7.8	03 AC JUMPER INS O 04/20/90 11:15	This message shows an example of "other" event - Access Jumper Installed.
A 7.9	04 SERIAL TRIP O 03/17/94 11:14	This message shows an example of "other" event - Serial Trip. This message is displayed if the breaker is closed when the 565/575 receives the Modbus Serial Trip command. If the breaker is open when this Serial Trip command is issued, it will be ignored.
A 7.10	05 SERIAL CLOSE O 03/17/94 11:15	This message shows an example of "other" event - Serial Close, if the breaker is open when the 565/575 receives the Modbus Serial Close command. If the breaker does not close successfully within the breaker discrepancy delay time, a breaker discrepancy will be declared. If the breaker is closed when this Serial Close command is issued, it will be ignored. In order to prevent conflicts with the Remote Trip/Close commands via hardware, the communication commands will only function if the Remote/Local switch at terminals #39 and #40 is in the "open" Local position.
A 7.11	PRINT EVENTS? NO	After all the events are viewed, pressing LINE DOWN key will show this message, which asks users if event printout is desired. Press NEXT CHOICE key to toggle YES or NO options and press STORE key to select it. (NOTE: Printer is presumably connected to the rear RS232 port). Press

Location	Message Line	Description
		LINE DOWN key to continue to the next message.
A 7.12	<pre>CLEAR EVENTS? NO</pre>	This message prompts the user to erase the event data displayed on this page.
A 7.13	<pre>EVENTS CLEARED LAST:AUG 04,1992</pre>	This message shows users when events were last cleared.
A 7.14	<pre>EVENTS END OF PAGE</pre>	The last line of EVENT page. Press the PAGE key to view page 8.

ACTUAL VALUES MODE - DEMAND DATA



Location	Message Line	Description
A 8.1	ACTUAL VALUES DEMAND DATA	The actual values page 8 header. This page allows the demand metering related data to be viewed.

Message A 8.2 will only appear if AMPS DEMAND is disabled in setpoints.

A 8.2 L _A	AMPS DEMAND DISABLED	This message informs the user that Amps Demand has been disabled.
-------------------------	-------------------------	---

Messages A 8.3 to A 8.5 will only be shown if the Amp Demand feature has been enabled in setpoints.

A 8.3	PH-A PEAK DEMAND 1050 A	This message shows the peak amps demand value of phase A since the last clearing of the function data.
-------	----------------------------	--

A 8.4	PH-B PEAK DEMAND 1100 A	This message shows the peak amps demand value of phase B since the last clearing of the function data.
-------	----------------------------	--

A 8.5	PH-C PEAK DEMAND 1070 A	This message shows the peak amps demand value of phase C since the last clearing of the function data.
-------	----------------------------	--

A 8.6	CLEAR AMP DEMAND DATA? NO	This message prompts the user if Demand Amps data is to be cleared. If YES, data stored will be erased.
-------	------------------------------	---

A 8.7	DATA CLEARED LAST:AUG 04,1992	This message shows users when data was last cleared.
-------	----------------------------------	--

The following messages are only displayed if a Metering Transducer Module (MTM) has been connected to the 565/575, an Option Card has been installed in the 565, and the communications has been enabled.

Message A 8.8 will appear only if the KW Demand feature has been disabled.

A 8.8	KW DEMAND DISABLED	This message informs the user the KW Demand has been disabled.
-------	-----------------------	--

Message A 8.9 will only appear if the KW Demand feature has been enabled.

A 8.9	PEAK KW DEMAND 65000 kW	This message shows the peak kW demand value since the last clearing.
-------	----------------------------	--

A 8.10	CLEAR KW DEMAND DATA? NO	This prompts the user if kW demand data is to be cleared. If YES, data stored will be erased.
--------	-----------------------------	---

A 8.11	KW DEMAND DATA CL'D:AUG 04,1992	This message shows the date when data was last cleared.
--------	------------------------------------	---

Location	Message Line	Description
----------	--------------	-------------

Message A 8.12 will only appear if KVAR Demand has been disabled in setpoints.

A 8.12	KVAR DEMAND DISABLED	This message informs the user that KVAR Demand has been disabled.
--------	-------------------------	---

Message A 8.13 will only appear if the KVAR Demand feature has been enabled.

A 8.13	PEAK KVAR DEMAND 65000 kVAR	This message shows the peak kVAR demand value since the last clearing.
--------	--------------------------------	--

A 8.14	CLEAR KVAR DEM'D DATA? NO	This prompts the user if KVAR demand data is to be cleared. If YES, data stored will be erased.
--------	------------------------------	---

A 8.15	KVAR DEMAND DATA CL'D:AUG 04,1992	This message shows the date when data was last cleared.
--------	--------------------------------------	---

A 8.16	DEMAND DATA END OF PAGE	The last line of DEMAND DATA page. Press the PAGE key to view page 9.
--------	----------------------------	---

www.ElectricalPartManuals.com

ACTUAL VALUES MODE - METERING DATA



Location Message Line Description

*** Available only with Option Card installed **

A 9.1

ACTUAL VALUES METERING DATA

 The Actual Values page 9 header. This page allows the metering data to be viewed.

Messages A 9.2 to A 9.6 will only appear if the Metering Transducer Module (MTM) has been enabled in setpoints.

A 9.2

POWER FACTOR LAGGING 0.75

 The Power Factor is displayed during this message.

A 9.3

FREQUENCY MTM 60.1 Hz

 This message displays the frequency.

A 9.4

REAL POWER 65000 kW

 This message displays the current real power delivered. If communicating with a rev. E MTM or MTM Plus, the kW polarity sign will be included.

A 9.5

REACTIVE POWER 65000 kVAR

 This message displays the current reactive power. If communicating with a rev. E MTM or MTM Plus, the kW polarity sign will be included.

A 9.6

ENERGY USED 65000 MWHRS

 This message displays the real power used.

A 9.7

CLEAR ENERGY USED DATA? NO

 This prompts the user if Energy Used Data is to be cleared. If YES, data stored will be erased. The MWhrs should be cleared after 65,000 in order to ensure safe operation.

MWh data on MTM can be cleared now by using 565/575 Relay's keypad or Modbus communication command.

A 9.7

METERING DATA END OF PAGE

 The last line of METERING DATA page. This is the last page of ACTUAL VALUES.

All the messages displayed by the 565 Relay in the setpoints mode are shown and explained in this section. As for actual values, the messages are laid out in book form with a number of pages. Each page contains lines displaying a message. The setpoints section has several pages, the contents of which are as follows:

Page Contents

1. User Level setpoints.
2. Phase Current setpoints.
3. Ground Current setpoints.
4. Configuration setpoints.
5. Analog Input setpoints.
6. Analog Output setpoints.
7. Communications setpoints.
8. Calibration Mode setpoints.
9. Voltage setpoints.
10. Demand Metering setpoints.
11. MTM Metering setpoints.

The numbers in the "Location" column to the left of each message in this section give the page and line of that message in the 565 Relay's memory. For example, the message to the right of the number S 1.2 in the "Location" column will appear on page 1 and line 2 when the Relay is in setpoints mode. The "Message Line" column shows the actual message which can be read from the LCD display on the front panel of the unit. The 565 Relay has two user levels, "basic" and "advanced". The messages seen depend on this user level, which is chosen in page one of setpoints. The basic level allows the user to operate the relay using the minimum of the features necessary. The advanced level allows the user to use all the 565 Relay features.

The messages which will only be seen by the advanced user and not the basic user, are marked "L_A", for "Level-advanced" in the Location column.

Quantities shown in display boxes are typical values only. Different quantities will be displayed in each particular application.

Relay Selection

The 565/575 Relay has six internal relays. They are called Trip, Close, Aux. 1, 2, 3, and 4. The following are the combinations of relays which you can select to have activated by any alarm or trip condition. This selection must be made in the setpoints mode.

ALARM RELAY SELECTION	TRIP RELAY SELECTION
1. Aux 1	1. Trip
2. Aux 2	2. Aux 1 (565 only)
3. Aux 1&2 (565 only)	3. Aux 2 (565 only)
	4. Trip & Aux 1
	5. Trip & Aux 2 (565 only)

6. Aux 1&2
7. Trip & Aux 1&2

The relay(s) to be activated can be displayed by pressing the NEXT CHOICE key. The display will show one of the options above, each time the key is pressed. When the last item is reached, the display will go back to the first item the next time the NEXT CHOICE key is pressed.

For example, say a combination of relays is being assigned to the undervoltage trip condition in setpoints. If the Trip relay and Auxiliary 1 relay need to be activated by this condition, the NEXT CHOICE key is pressed until the display shows

UNDERVOLT TRIP
 RELAY TRIP&AUX1

The STORE key is then pressed to store the selected relay or combination of relays in the 565/575 Relay's memory. The following message will appear for two seconds to verify that this has been done.

NEW SETPOINT
 STORED

When more than one relay is selected as shown, all the selected relays will be energized simultaneously. The contacts of the selected relay(s) can then be used to provide remote alarms or trips. These contacts are available at the rear of the 565 Relay panel. See the wiring diagram for terminal numbers.

Setpoint Message Abbreviations

The following abbreviations are used in the messages in the setpoints pages:

A	Ampere
ALM	Alarm
AUX	Auxiliary
COMM	Communications
CT	Current Transformer
CURR	Current
CYC	Cycles
DISCREP.	Discrepancy
EXTREM	Extremely
FREQ	Frequency
GND	Ground
Hz	Hertz
INST	Instantaneous
INV	Inverse
KA	Kiloamps
KV	Kilovolts
KVAR	Kilovars
KW	Kilowatts
LCD	Liquid Crystal Display
mA	Milliamps

SETPOINTS MODE



MAX	Maximum
MIN	Minimum, or Minutes
MOD	Moderately
mS	Milliseconds
MTM	Metering Transducer Module
O/C	Overcurrent
OVERVOLT	Overvoltage
P/F	Power Factor
REV	Revision
SEC	Secondary, or Second
SW	Switch
UNDERVOLT	Undervoltage
VOLTS	Voltage
VT	Voltage Transformer
x P/U	Multiple of Pickup Level
ZERO SEQ	Zero Sequence

www.ElectricalPartManuals.com

Summary of Setpoint Page Contents

Page	Contents	Page	Contents
1.	User Level setpoints. User level Security Feature/Access code	5.	Analog Input setpoints. Analog input title and units Min and max current scale values Analog input trip Analog input alarm
2.	Phase Current setpoints. Phase CT primary rating Phase overcurrent pickup level Phase overcurrent curve shape Phase overcurrent time dial Phase overcurrent trip relay Phase overcurrent alarm Phase instantaneous trip (565 only) Phase custom curve trip times (565 only) Phase HISET instantaneous trip (575 only) Phase autoblock HISET (575 only) Phase LOSET instantaneous trip (575 only) Phase custom curves 1 trip times (575 only)	6.	Analog Output setpoints. Analog output parameters Analog output range
3.	Ground Current setpoints. Ground sensing system Ground CT primary rating Ground overcurrent pickup level Ground overcurrent curve shape (565 only) Ground overcurrent curve 1 shape (575 only) Ground overcurrent time dial (565 only) Ground overcurrent time dial 1 (575 only) Ground overcurrent trip relay Ground overcurrent alarm Ground instantaneous trip (565 only) Ground HISET instantaneous trip (575 only) Ground autoblock HISET (575 only) Ground LOSET instantaneous trip (575 only) Ground autoblock LOSET (575 only) Ground custom curve trip times Ground custom curve 1 trip times (575 only)	7.	Communications setpoints. Relay address Baud rate
4.	Configuration Setpoints. Clock Switch contact functions Switch contact configurations Relay assignments Breaker response delay Breaker discrepancy delay Trip coil supervision Accumulated KA Event recording Event printing Cold load P/U delay MTM communications enable	8.	Calibration Mode setpoints. Exercise relay Status of switch inputs LCD display contrast Multilin 565 Relay Revision
		9.	Voltage setpoints. VT connection VT nominal secondary volts VT primary volts Zero volts detect Undervoltage trip Undervoltage alarm Overvoltage trip Overvoltage alarm
		10.	Demand Metering setpoints. Amps demand KW demand KVAR demand

SETPOINTS MODE



Summary of Setpoint Page Contents

Page	Contents	Page	Contents
11.	MTM Metering setpoints. MTM communications alarm MTM CT select MTM CT primary rating Power factor alarm Power factor trip Frequency alarm Frequency trip MTM scaling factor Voltage reversal trip		
12.	Auto Reclosure setpoints. (575 only) Number of reclosure shots Shot dead times Scheme reset time Reclosure enable relay		
13.	Phase Curves setpoints. (575 only) Phase curve changeover time Phase overcurrent curve 2 shape Phase overcurrent time dial 2 Phase custom curve 2 trip times		
14.	Ground Curves setpoints. (575 only) Ground curves setpoints Ground overcurrent curve 2 shape Ground overcurrent time dial 2 Ground custom curve 2 trip times		

Setpoint Name	Factory Default	Range	Step
1. User Level setpoints.			
User Level	Advanced.	Basic/Advanced	
Security Feature	Disabled.	Enabled/Disabled	
Setpoint Access	Enabled.	Enabled/Disabled	
Change Access Code	No.	Yes/No	
2. Phase Current setpoints.			
Phase CT Rating Primary	100 A.	10 to 5000A	5A
Phase Timed O/C Pickup	100% CT.	25 to 250%	1%
Phase O/C Curve Shape	EXTREM INV.	MOD INV, NORMAL INV, VERY INV, EXTREM INV, and CUSTOM	
Phase O/C Time Dial	1.	1 to 32	1
Phase O/C Trip Relay	Trip. (Trip&Aux1 for 575)	Trip, Aux1, Aux2, Trip&Aux1, Trip&Aux2, Aux1&2, and Trip&Aux1&2 (575: Trip, Trip&Aux1, Aux2)	
Phase O/C Alarm	Disabled.	Enabled/Disabled	
Phase O/C Alarm Level	1.5 × P/U	0.5 to 3	0.1
Phase O/C Alarm Delay	1 Sec.	1 to 255 sec	1 sec
Phase O/C Alarm Relay	Aux1. (Aux2 for 575)	Aux1, Aux2, and Aux1&2 (575: None, Aux1, Aux2, Aux1&2)	
Phase Inst Trips	Enabled.	Enabled/Disabled	
Phase Inst Trip Level	3.0 × P/U (565)	1 to 18	0.5
Phase Inst Trip Delay	Inst. (565)	0 (Inst.) to 40 cycles	1 cycle
Phase Inst Trip Relay	Trip. (565)	Trip, Aux1, Aux2, Trip&Aux1, Trip&Aux2, Aux1&2, and Trip&Aux1&2	
Phase HISET Inst Trips	Enabled.	Enabled/Disabled	
Phase HISET Inst Trip	3.0 × P/U	1 to 18	0.5
Phase HISET Inst Delay	Inst.	0 (Inst.) to 40 cycles	1 cycle
Phase HISET Inst Relay	Trip & Aux1.	Trip, Trip&Aux1, Aux2	
Phase Autoblock Inst HISET	Disabled.	Enabled/Disabled	
Ph. Autoblock HISET After Recl.	#4. (575)	1 to 4	1
Phase LOSET Inst Trips	Enabled.	Enabled/Disabled	
Phase LOSET Inst Trip	2.0 × P/U	1 to 18	0.5
Phase LOSET Inst Delay	Inst.	0 (Inst.) to 40 cycles	1 cycle
Phase LOSET Inst Relay	Trip & Aux 1.	Trip, Trip&Aux1, Aux2	
Phase Autoblock Inst LOSET	Disabled.	Enabled/Disabled	
Ph. Autoblock LOSET After Recl.	#4	1 to 4	
Trip Time (Sec) × P/U	1.0	0.1 to 1092.2 sec	0.1 sec
3. Ground Current setpoints.			
Ground Current Sensing	Enabled.	Enabled/Disabled	
Sensing System	Residual.	Residual/Zero Seq	
CT Ratio Primary	100 A.	10 to 5000A	5A
Ground Timed O/C Pickup	40% CT.	5 to 100%	1%
Gnd O/C Curve Shape	EXTREM INV.	MOD INV, NORMAL INV, VERY INV, EXTREM INV, and CUSTOM	
Ground O/C Time Dial	1.	1 to 32	1
Ground O/C Relay	Trip. (Trip&Aux1 for 575)	Trip, Aux1, Aux2, Trip&Aux1, Trip&Aux2, Aux1&2, and Trip&Aux1&2 (575: Trip, Trip&Aux1, Aux2)	
Ground O/C Alarm	Disabled.	Enabled/Disabled	
Gnd O/C Alarm Level	1.5 × P/U	0.5 to 1	0.1
		1 to 3	0.5
Gnd O/C Alarm Delay	1 Sec.	1 to 255 sec	1 sec
Gnd O/C Alarm Relay	Aux1. (Aux2 for 575)	Aux1, Aux2, and Aux1&2 (575: None, Aux1, Aux2, Aux1&2)	
Ground Inst Trips	Enabled.	Enabled/Disabled	
Gnd Inst Trip Level	3.0 × P/U	1 to 7	0.5

SETPOINTS MODE



Setpoint Name	Factory Setpoint	Range	Step
Gnd Inst Trip 2 Level	3.0 × P/U	1 to 8	0.1
Gnd Inst Trip Delay	Inst.	0 (Inst.) to 40 cycles	1 cycle
Gnd Inst Trip Relay	Trip.	Trip, Aux1, Aux2, Trip&Aux1, Trip&Aux2, Aux1&2, and Trip&Aux1&2	
Gnd HISET Inst Trips	Enabled.	Enabled/Disabled	
Gnd HISET Inst Trip	3.0 × P/U	1 to 7	0.5
Gnd HISET Inst Delay	Inst.	0 (Inst.) to 40 cycles	1 cycle
Gnd HISET Inst Relay	Trip&Aux1	Trip, Trip&Aux1, Aux2	
Gnd Autoblock Inst HISET	Disabled.	Enabled/Disabled	
Gnd Autoblock HISET After Recl.	#4.	1 to 4	1
Gnd LOSET Inst Trips	Enabled.	Enabled/Disabled	
Gnd LOSET Inst Trip	2.0 × P/U	1 to 7.0	0.5
Gnd LOSET Inst Delay	Inst.	0 (Inst.) to 40 cycles	1 cycle
Gnd LOSET Inst Relay	Trip&Aux1.	Trip, Trip&Aux1, Aux2	
Gnd Autoblock Inst LOSET	Disabled.	Enabled/Disabled	
Gnd Autoblock LOSET After Recl.	#4.	1 to 4	1
Trip Time (Sec) × P/U	1.0	0.1 to 1092.2 sec	0.1 sec

4. Configuration setpoints.

Set Time	Current time. (hh:mm:ss)	00:00:00 to 23:59:59	1 sec.
Set Date	Current date. (mm/dd/yy)	Jan 01, 1969 to Dec 31, 2068	1 day

Switch Contact Function.

Reset Blocked	Disabled.	Disabled, SW1 to SW8	
Block Inst Trips	Disabled.	Disabled, SW1 to SW8	
Block Timed O/C Trips	Disabled.	Disabled, SW1 to SW8	
Block Gnd Trips	Disabled.	Disabled, SW1 to SW8	
Definite Time #1 Alarm	Disabled.	Disabled, SW1 to SW8	
Definite Time #1 Delay	1 Sec.	1 to 255 sec	1 sec
Definite Time #1 Relay	Aux2.	Aux1, Aux2, and Aux1&2 (575: None, Aux1, Aux2, Aux1&2)	
Definite Time #2 Alarm	Disabled.	Disabled, SW1 to SW8	
Definite Time #2 Delay	1 Sec.	1 to 255 sec	1 sec
Definite Time #2 Relay	Aux2.	Aux1, Aux2, and Aux1&2 (575: None, Aux1, Aux2, Aux1&2)	
External Trip #1	Disabled.	Disabled, SW1 to SW8	
External Trip #1 Relay	Trip & Aux1.	Trip, Aux1, Aux2, Trip&Aux1, Trip&Aux2, Aux1&2, and Trip&Aux1&2	
External Trip #1 Delay	0 cyc.	0 (Inst.) to 60 cycles	1 cyc
External Trip #2	Disabled.	Disabled, SW1 to SW8	
External Trip #2 Relay	Trip & Aux1.	Trip, Aux1, Aux2, Trip&Aux1, Trip&Aux2, Aux1&2, and Trip&Aux1&2	
External Trip #2 Delay	0 cyc.	0 (Inst.) to 60 cycles	1 cyc
External Trip #3	Disabled.	Disabled, SW1 to SW8	
External Trip #3 Relay	Trip & Aux1.	Trip, Aux1, Aux2, Trip&Aux1, Trip&Aux2, Aux1&2, and Trip&Aux1&2	
External Trip #3 Delay	0 cyc.	0 (Inst.) to 60 cycles	1 cyc
External Trip #4	Disabled.	Disabled, SW1 to SW8	
External Trip #4 Relay	Trip & Aux1.	Trip, Aux1, Aux2, Trip&Aux1, Trip&Aux2, Aux1&2, and Trip&Aux1&Aux2	
External Trip #4 Delay	0 cyc.	0 (Inst.) to 60 cycles	1 cyc
Curve Adjustment	Disabled.	Disabled, SW1 to SW8	
External Reset	Disabled.	Disabled, SW1 to SW8	
External Trip	Disabled. (575)	Disabled, SW1 to SW8	
External Trip Relay	Trip&Aux1. (575)	Trip, Trip&Aux1, Aux2	
External Trip Delay	Inst. (575)	0 (Inst.) to 60 cycles	1 cycle
Reclosable Trip	Disabled. (575)	Disabled, SW1 to SW8	

Setpoint Name	Factory Setpoint	Range	Step
Reclosable Trip Relay	Trip&Aux1.	Trip, Trip&Aux1, Aux2	
Programmable Trip	Disabled.	Disabled, SW1 to SW8	
Programmable Trip Relay	Trip&Aux1.	Trip, Trip&Aux1, Aux2	
Programmable Trip Type	Non-Recls.	Recls/Non-Recls	
Curve Adjustment	Disabled.	Disabled, SW1 to SW8	
Alternative Phase Curve	Disabled.	Disabled, SW1 to SW8	
Alternative Ground Curve	Disabled.	Disabled, SW1 to SW8	
Auto-Reclosure Block	Disabled.	Disabled, SW1 to SW8	
External Reset	Disabled.	Disabled, SW1 to SW8	

Switch Contact Configuration.

SW1 Contact	Normally Open (inactive).	Open/Closed
SW2 Contact	Normally Open (inactive).	Open/Closed
SW3 Contact	Normally Open (inactive).	Open/Closed
SW4 Contact	Normally Open (inactive).	Open/Closed
SW5 Contact	Normally Open (inactive).	Open/Closed
SW6 Contact	Normally Open (inactive).	Open/Closed
SW7 Contact	Normally Open (inactive).	Open/Closed
SW8 Contact	Normally Open (inactive).	Open/Closed

Output Relay Operation.

Trip Relay	Pulsed. (565)	Latched/Pulsed	
Trip Relay Pulse Time	0.6 Sec. (565)	0.1 to 0.6 sec	0.1 sec
Aux1 Relay	Unlatched. (Pulsed for 575)	Latched, Unlatched, and Pulsed	
Aux1 Relay Pulse Time	0.6 Sec. (0.1 Sec. for 575)	0.1 to 0.6 sec	0.1 sec
Aux2 Relay	Unlatched.	Latched, Unlatched, and Pulsed	
Aux2 Relay Pulse Time	0.6 Sec.	0.1 to 0.6 sec	0.1 sec

575 Features.

Breaker Response Delay	1ms.	1 to 167ms	1ms
Breaker Discrep.	Disabled. (565)	Enabled/Disabled	
Breaker Discrep. Delay	1000mS.	100 to 1000mS	10mS
Trip Coil Supervision	Disabled.	Enabled/Disabled	
Accumulated KA Alarm	Disabled.	Enabled/Disabled	
Accumulated KA Alarm	5000.	5000 to 100,000KA	10KA
KA Alarm Relay	Aux1. (Aux2 for 575)	Aux1, Aux2, and Aux1&2 (575: None, Aux1, Aux2, Aux1&2)	
Event Recording	Enabled.	Enabled/Disabled	
Event Printing	Offline.	Online/Offline	
Cold Load P/U Block	Lowset. (575)	Lowset, Highset, Both	
Cold Load P/U Delay	0.0 Sec.	0 to 10 sec	0.1 sec
MTM Comm	Enabled.	Enabled/Disabled	

5. Analog Input setpoints.

Analog Input	Disabled.	Enabled/Disabled	
Edit Analog Input Title?	No.	Yes/No	
Edit Analog Input Units?	No.	Yes/No	
Min Curr Scale Value	4.00.	0 to 1023	0.01
Max Curr Scale Value	20.00.	0 to 1023	0.01
Analog Input Trip	Disabled.	Enabled/Disabled	
Analog In Trip	16.00.	Min Curr Scale Value to Max Curr Scale Value	
Analog In Trip Delay	1 Sec.	1 to 255 sec	1 sec
Analog In Trip Relay	Trip. (Trip&Aux1 for 575)	Trip, Aux1, Aux2, Trip&Aux1, Trip&Aux2, Aux1&2, and Trip&Aux1&2	
Analog Input Alarm	Disabled.	Enabled/Disabled	

SETPOINTS MODE



Setpoint Name	Factory Setpoint	Range	Step
Analog In Alarm	12.00.	Min Curr Scale Value to Max Curr Scale Value	
Analog In Alarm Delay	1 Sec.	1 to 255 sec	1 sec
Analog In Alarm Relay	Aux1. (Aux2 for 575)	Aux1, Aux2, Aux1&2 (575: None, Aux1, Aux2, Aux1&2)	
6. Analog Output setpoints.			
Analog Output Parameter	Phase A Current.	Phase A Current, Phase B Current, Phase C Current, Ground Current, Phase A-X Voltage, Phase B-X Voltage, Phase C-X Voltage, Feeder Frequency, and External Analog Select	
Analog Output Range:	4-20 mA.	0-1mA or 4-20mA	
7. Communication setpoints.			
Relay Address	1.	1 to 254	1
Baud Rate	2400 BAUD.	1200, 2400, 4800, and 9600 Baud	
8. Calibration Mode setpoints.			
Exercise Relay	Trip.	Trip, Aux1, Aux2, Aux3, and All (565) Trip, Aux1, Aux2, Aux3, Aux4, Block Tap Changer, and All (575)	
(Status of Switch Inputs)			
LCD Display Contrast	5.	0 to 10	1
9. Voltage setpoints.			
VT Connection	Wye.	Wye, Open Delta, Delta/Wye and None	
VT Nominal Sec Volts	120 Volts.	48 to 240 Volts	
VT Primary Volts	1.2 kV.	0.1 to 69 kV	0.01 kV
Zero Volts Detect	Disabled.	Enabled/Disabled	
Undervolt Trip	Disabled.	Enabled/Disabled	
Undervolt Trip Level	80% VT	50 to 100%	1%
Undervolt Trip Delay	1.0 Sec.	0.1 to 25.5 sec	0.1 sec
Undervolt Trip Relay	Trip & Aux1.	Trip, Aux1, Aux2, Trip&Aux1, Trip&Aux2, Aux1&2, and Trip&Aux1&2 (575: Trip, Trip&Aux1, Aux2)	
Undervolt Alarm	Disabled.	Enabled/Disabled	
Undervolt Alarm Level	85% VT	50 to 100%	1%
Undervolt Alarm Delay	1.0 Sec.	0.1 to 25.5 sec	0.1 sec
Undervolt Alarm Relay	Aux2.	Aux1, Aux2, and Aux1&2 (575: None, Aux1, Aux2, Aux1&2)	
Overvolt Trip	Disabled.	Enabled/Disabled	
Overvolt Trip Level	120% VT	101 to 125%	1%
Overvolt Trip Delay	1.0 Sec.	0.1 to 25.5 sec	0.1 sec
Overvolt Trip Relay	Trip. (Trip&Aux1 for 575)	Trip, Aux1, Aux2, Trip&Aux1, Trip&Aux2, Aux1&2, and Trip&Aux1&2 (575: Trip, Trip&Aux1, Aux2)	
Overvolt Alarm	Disabled.	Enabled/Disabled	
Overvolt Alarm Level	115% VT	101 to 125%	1%
Overvolt Alarm Delay	1.0 Sec.	0.1 to 25.5 sec	0.1 sec
Overvolt Alarm Relay	Aux1. (Aux2 for 575)	Aux1, Aux2, Aux1&2 (575: None, Aux1, Aux2, Aux1&2)	
10. Demand Metering setpoints.			
Amps Demand	Enabled.	Enabled/Disabled	
Amps Demand Time Period	5 Min.	5 to 120 Min	1 Min
Amps Demand Alarm	Disabled.	Enabled/Disabled	
Amp Demand Alarm Level	100 A.	10 to 5000 A	5 A

Location	Message Line	Description
Amp Demand Alarm Relay	Aux1. (Aux2 for 575)	Aux1, Aux2, Aux1&2 (575: None, Aux1, Aux2, Aux1&2)
KW Demand	Enabled.	Enabled/Disabled
KW Demand Time Period	5 Min.	5 to 120 Min 1 Min
KW Demand Alarm	Disabled.	Enabled/Disabled
KW Demand Alarm Level	1000 kW.	100 to 65,000 kW 100 kW
KW Demand Alarm Relay	Aux1. (Aux2 for 575)	Aux1, Aux2, Aux1&2 (575: None, Aux1, Aux2, Aux1&2)
KVAR Demand	Enabled.	Enabled/Disabled
KVAR Demand Time Period	5 Min.	5 to 120 Min 1 Min
KVAR Demand Alarm	Disabled.	Enabled/Disabled
KVAR Demand Al'm Level	1000 kVAR.	100 to 65,000 kVAR 100 kVAR
KVAR Demand Al'm Relay	Aux1. (Aux2 for 575)	Aux1, Aux2, Aux1&2 (575: None, Aux1, Aux2, Aux1&2)

11. MTM Metering setpoints.

MTM Comm. Alarm	Disabled.	Enabled/Disabled
MTM Comm. Alarm Relay	Aux2.	Aux1, Aux2, Aux1&2
MTM CT Select	Common.	Common/Separate
MTM CT Rating Primary	100 A.	5 to 5000 A 5 A
Power Factor Alarm	Disabled.	Enabled/Disabled
P/F Leading Alarm Level	0.75.	0 to 1 0.05
P/F Lagging Alarm Level	0.75.	0 to 1 0.05
P/F Alarm Delay	5.0 Sec.	1 to 127 sec 0.5 sec
P/F Alarm Relay	Aux1. (Aux2 for 575)	Aux1, Aux2, and Aux1&2 (575: None, Aux1, Aux2, Aux1&2)
Power Factor Trip	Disabled.	Enabled/Disabled
P/F Leading Trip Level	0.70.	0 to 1 0.05
P/F Lagging Trip Level	0.70.	0 to 1 0.05
P/F Trip Delay	1.0 Sec.	1 to 127 sec 0.5 sec
P/F Trip Relay	Aux1. (Trip&Aux1 for 575)	Trip, Aux1, Aux2, Trip&Aux1, Trip&Aux2, Aux1&2, and Trip&Aux1&2 (575: Trip, Trip&Aux1, Aux2)
Frequency Alarm	Disabled.	Enabled/Disabled
Under Freq. Alarm Level	58.0 Hz.	40 to 60 Hz 0.1 Hz
Over Freq. Alarm Level	62.0 Hz.	50 to 72 Hz 0.1 Hz
Frequency Alarm Delay	5.0 Sec.	1 to 127 sec 0.5 sec
Frequency Alarm Relay	Aux1. (Aux2 for 575)	Aux1, Aux2, Aux1&2 (575: None, Aux1, Aux2, Aux1&2)
Frequency Trip	Disabled.	Enabled/Disabled
Under Freq. Trip Level	56.0 Hz.	40 to 60 Hz 0.1 Hz
Over Freq. Trip Level	64.0 Hz.	50 to 72 Hz 0.1 Hz
Frequency Trip Delay	1.0 Sec.	1 to 127 sec 0.5 sec
Frequency Trip Relay	Aux1. (Trip&Aux1 for 575)	Trip, Aux1, Aux2, Trip&Aux1, Trip&Aux2, Aux1&2, and Trip&Aux1&2 (575: Trip, Trip&Aux1, Aux2)
MTM Scaling Factor	655.	1 to 655 1
Voltage Reversal Trip	Disabled.	Enabled/Disabled
Voltage Reversal Delay	1.0 sec.	1 to 127 sec. 0.5 sec
Voltage Reversal Relay	Trip	Trip, Aux1, Aux2, Trip&Aux1, Trip&Aux2, Aux1&Aux2, Trip&Aux1&Aux2 (575: Trip, Trip&Aux1, Aux2)

12. Auto Reclosure setpoints. (575 only)

Auto Reclosure	Disabled.	Enabled/Disabled
No. Of Reclose Shots	4.	0 to 4 1
Shot 1 Dead Time	2.0 sec.	0.3 to 300 sec. 0.1 sec.
Shot 2 Dead Time	4.0 sec.	0.3 to 300 sec. 0.1 sec.
Shot 3 Dead Time	6.0 sec.	0.3 to 300 sec. 0.1 sec.
Shot 4 Dead Time	8.0 sec.	0.3 to 300 sec. 0.1 sec.
Scheme Reset Time	5.0 sec.	1 to 255 sec. 1 sec.
Reclosure Enable Relay	Aux2.	None, Aux1, Aux2, Aux1&2

13. Phase Curves setpoints. (575 only)

SETPOINTS MODE



Setpoint Name	Factory Setpoint	Range	Step
Phase Curve Change	Disabled.	Enabled/Disabled	
Switch to Curve 2 After Recls.	#1.	1 to 4	1
Phase O/C Curve 2 Shape	EXTREM INV.	MOD INV, NORMAL INV, VERY INV, EXTREM INV, and CUSTOM2	
Phase O/C Time Dial 2	1.	1 to 32	1
Trip Time 2 (sec) × P/U	1.0	0.1 to 1092.2 sec.	0.1 sec.
14. Ground Curve setpoints. (575 only)			
Ground Curve Change	Disabled.	Enabled/Disabled	
Switch to Curve 2 After Recls.	#1.	1 to 4	1
Ground O/C Curve 2 Shape	EXTEM INV.	MOD INV, NORMAL INV, VERY INV, EXTREM INV, and CUSTOM2	
Ground O/C Time Dial 2	1.	1 to 32	1
Trip Time 2 (sec) × P/U	1.0	0.1 to 1092.2 sec.	0.1 sec.

Setpoints.

Location	Message Line	Description
S 1.1	<div style="border: 1px solid black; padding: 5px; text-align: center;"> SETPOINTS USER LEVEL </div>	The setpoints page 1 header. In this page the setpoints for selecting the user level and for enabling the security feature are entered.
S 1.2	<div style="border: 1px solid black; padding: 5px; text-align: center;"> USER LEVEL: ADVANCED </div>	This message allows the user to select one of two possible levels, which are Basic and Advanced. If the Basic level is chosen, then the user will only see those messages essential to the setup of the 565/575 relay. If the Advanced level is chosen, all the features of the relay will be made available to the user. The extra messages only seen by the advanced user are marked "L _A " in the "Location" column. Select either BASIC or ADVANCED using the NEXT CHOICE key and store the value.

NOTE: For simple step-by-step instructions on installation and use of the access code, see information at end of USER LEVEL setpoint page.

S 1.3	<div style="border: 1px solid black; padding: 5px; text-align: center;"> SECURITY FEATURE DISABLED </div>	This message allows the user to enable a feature which uses a numeric code, as well as the access jumper, to prevent unauthorized personnel from changing setpoints. The Security Feature cannot be enabled on the 565 if the Security Feature and local Setpoint Access setpoints are disabled via Relaycom™.
-------	---	--

Messages S 1.4 to S 1.9 will only appear if ENABLE is selected and stored in message S 1.3.

S 1.4	<div style="border: 1px solid black; padding: 5px; text-align: center;"> SETPOINT ACCESS ENABLED </div>	If enabled is selected and stored in this message, access to setpoints is permitted. If disabled is selected and stored, the security access code is in effect and all access to setpoints will be denied.
-------	---	--

NOTE: The first time the security feature is enabled the message "SETPOINT ACCESS" will be set to enabled. This will allow entry of a personalized code using message S 1.6. Once "SETPOINT ACCESS" is set to disabled, the access code will be required to enable access again. If this is done before an access code has been stored, the factory default value for access is 0.

Message S 1.5 will only appear if message S 1.4 is changed to enabled from previously being disabled.

S 1.5	<div style="border: 1px solid black; padding: 5px; text-align: center;"> ENTER ACCESS CODE </div>	<p>This message asks for the access code which must be entered before setpoint access is enabled.</p> <p>Note that as the code is being entered the cursor "_" will appear instead of the numbers to verify the entry of the numbers, and prevent unauthorized personnel from reading the code.</p>
-------	---	---

S 1.6	<div style="border: 1px solid black; padding: 5px; text-align: center;"> CHANGE ACCESS CODE NO </div>	This message is used to set up the access code for the first time, and then to change the access code whenever the need arises.
-------	--	---

Messages S 1.7 to S 1.9 will only appear if YES is selected and stored in message S 1.6.

S 1.7	<div style="border: 1px solid black; padding: 5px; text-align: center;"> ENTER NEW ACCESS CODE </div>	This message asks the user to enter their own personalized code. Any number from 0-9999 can be used.
S 1.8	<div style="border: 1px solid black; padding: 5px; text-align: center;"> RE-ENTER NEW ACCESS CODE </div>	This message asks that the new access code be re-entered to ensure that the correct code is stored.

SETPOINTS MODE



Location	Message Line	Description
S 1.9	NEW ACCESS CODE STORED	This is a flash message that appears for two seconds to tell the user that the new access code is now stored in the 565's memory.
S 1.10	USER LEVEL END OF PAGE	This is the last line of page 1, setpoints. Press PAGE to view page 2.

Installation of Security Feature:

STEP 1 : Display message S 1.3 "Security Feature". Press NEXT CHOICE to display enabled and press store.

STEP 2 : Display message S 1.6 "Change Access Code". Press NEXT CHOICE to display YES and press store.

STEP 3 : By pressing store in step 2, message S 1.7 now appears. Any number from 0-9999 can now be entered for an access code. Enter number and press STORE.

STEP 4 : Re-enter access code, press STORE.

STEP 5 : Display message S 1.4. Use NEXT CHOICE to display disabled and press STORE.

Use of Access Code:

STEP 1 : Display message S 1.4 "SETPOINT ACCESS". Press NEXT CHOICE to display enabled and press STORE.

STEP 2 : Enter your personalized code and press STORE.

STEP 3 : Access to setpoints is now permitted.

STEP 4 : After all changes have been made, display message S 1.4 "SETPOINT ACCESS". Press NEXT CHOICE to display disabled and press STORE.

STEP 5 : Setpoint access is now disabled. An attempt to alter a setpoint will result in an "ILLEGAL ACCESS" message.

www.ElectricalPartManuals.com

SETPOINTS MODE - PHASE CURRENT



Location Message Line Description

S 2.1

SETPOINTS PHASE CURRENT

The setpoints page 2 header. In this page you must enter information about the phase current transformers being used in your application. This allows the 565/575 Relay to accurately sense the feeder currents. This page also allows you to set the levels for various overcurrent alarms and trips and assign relays to be activated by these.

Each of the four phase currents are sampled at a rate of approximately 960 samples per second.

S 2.2

PHASE CT RATING PRIMARY 100 A

Enter the primary current rating of the phase current transformers being used. This value is found on the transformer nameplate. Values can be entered in the range of 10 to 5000 Amps, in steps of 5 Amp. If an attempt is made to enter a value outside this range an OUT OF RANGE error message will flash. If your transformer has a rating outside this range contact MULTILIN for information. Note that all three phase CT's must have the same rating.

S 2.3

PHASE TIMED O/C PICKUP 100 %CT
--

The phase overcurrent pickup level is entered here. This is given as a percentage of the CT rating, in the range of 25% to 250% in steps of 1%. This setting will determine the level of current which the 565 Relay will identify as too high, and then initiate a timed overcurrent trip of the breaker, according to the selected curve shape.

For example, if 50% is entered here, then the 565/575 Relay will initiate a timed trip of the feeder breaker when at least one of the phase currents reaches 50% of the full CT rating entered in message S 2.2. Determine this value by referring to the feeder design specifications.

S 2.4

PHASE O/C CURVE SHAPE EXTREM INV
--

The shape of the required protection curve must be entered here. The curve names are shown below together with the shortened form of the name which is displayed in this message.

CURVE NAME	DISPLAYED NAME
1. Moderately inverse.	MOD INV.
2. Normal Inverse.	NORMAL INV.
3. Very Inverse.	VERY INV.
4. Extremely Inverse.	EXTREM INV.
5. Custom Curve.	CUSTOM
6. IEC	IEC A
7. IEC	IEC B
8. IEC	IEC C

Once the correct curve has been chosen for your application, press the NEXT CHOICE key until the required curve is displayed in message S 2.4 and store the selected curve using the STORE key. The extremely inverse curve is shown in this example.

Message S 2.5 will not appear if CUSTOM CURVE is selected in message S 2.4.

S 2.5

PHASE O/C TIME DIAL 1

The phase overcurrent time dial number is entered here. This allows the user to fit the selected curve to the system requirements. Any of the 32 possible plots of the selected curve shape may be selected by entering the corresponding number between 1 and 32 here. Select the curve number by referring to the "use of standard curves" in section 3.

S 2.6

PHASE O/C TRIP RELAY TRIP

This message allows the user to select the relay which the phase overcurrent trip will activate.

Location	Message Line	Description
S 2.7 L _A	PHASE O/C ALARM DISABLED	This message allows the user to enable or disable the phase overcurrent alarm. Use the NEXT CHOICE key to select enabled or disabled.

Messages S 2.8 to 2.10 will only appear if ENABLED is selected in message S 2.7.

S 2.8 L _A	PHASE O/C ALARM LEVEL 1.5 X P/U	This is the value of current flowing in any phase which will cause the Relay to initiate an alarm. This value is entered as a multiple of the phase timed overcurrent pickup level chosen in message S 2.3. Values can be entered in these ranges:
-------------------------	------------------------------------	--

1). 0.5 to 3 in steps of 0.1.

If a value which is not an exact multiple of 0.1 or 0.5 is entered, the 565 Relay will select the closest number to the value entered, display and use it. For example, if 1.4 is entered then a value of 1.5 will be displayed and used by the 565 Relay. Attempting to enter a value outside these ranges will cause an OUT OF RANGE error message to flash.

Choose alarm values lower than the trip pickup levels by an amount which will give adequate warning of impending problems. For example a value of 80% of the phase timed overcurrent level might be chosen, and 0.8 would be entered here. A level of 1 times pickup can be programmed. The LCD will then indicate when the Relay is operating above pickup.

S 2.9 L _A	PHASE O/C ALARM DELAY 1 SEC	The value of the timed overcurrent alarm delay is entered here in the range of 1 to 255, in steps of 1 second. The purpose of the time delay is to prevent alarms due to momentary high currents which occur when large equipment is switched on or off the feeder. If the current drops below the alarm setting before the time delay which you select, no alarm will be initiated.
-------------------------	--------------------------------	--

S 2.10 L _A	PHASE O/C ALARM RELAY AUX1	This message allows the user to select the relay which the alarm generated in message S 2.8 will activate.
--------------------------	-------------------------------	--

S 2.11	PHASE INST TRIPS ENABLED	This setpoint allows the user to enable or disable the phase instantaneous trip protection in the 565 and 575.
--------	-----------------------------	--

(575)	PHASE HISET INST TRIPS ENABLED
-------	-----------------------------------

Messages S 2.12 to 2.14 will only appear if ENABLED is selected in message S 2.11.

S 2.12	PHASE INST TRIP LEVEL 3.0 X P/U	The instantaneous overcurrent trip level for all phases is entered here as a multiple of the pickup level already set in message S 2.3. The range is 1 to 18 in steps of 0.5. This feature protects the feeder from sudden very high currents which cannot be tolerated without machine damage.
--------	------------------------------------	---

(575)	PHASE HISET INST TRIPS 3.0 X P/U
-------	-------------------------------------

For example, if the phase overcurrent pickup level was 100 Amps, and a setting of 5 was chosen here then a current of 500 or higher amps in any phase, for longer than the time specified in the next message will cause a trip signal to be produced by the 565/575 Relay.

SETPOINTS MODE - PHASE CURRENT



Location	Message Line	Description
S 2.13	<div style="border: 1px solid black; padding: 5px;"> PHASE INST TRIP DELAY INST </div> <div style="border: 1px solid black; padding: 5px;"> PHASE HISET INST DELAY INST </div> (575)	<p>The intentional delay on the phase instantaneous trip is set here in the range 0 to 40 cycles in steps of one cycle. If 0 is selected, INST will be displayed and there will be no intentional delay. There is, however, a 1 cycle delay which is necessary for the 565/575 relay to react to the fault condition. If any other value is entered within the above range, the trip will occur in this above reaction time plus the entered value. Thus, for an entered delay of 2 cycles on a 60 Hz system, the actual time to trip on phase instantaneous is $3 \times 16.6 \text{ ms} = 50 \text{ ms}$.</p> <p>Definite time characteristics can be implemented by using the phase instantaneous trip and appropriate time delays. For example, the phase instantaneous trip setpoint can be enabled and a delay between 0–40 cycles programmed. This effectively will simulate a Definite Time curve.</p>
S 2.14	<div style="border: 1px solid black; padding: 5px;"> PHASE INST TRIP RELAY TRIP </div> <div style="border: 1px solid black; padding: 5px;"> PHASE HISET INST RELAY TRIP&AUX1 </div> (575)	<p>This message allows the user to select the relay or combination of relays which the trip generated in message S 2.11 will activate.</p>
<p>Messages S 2.15 to S 2.22 pertain to the 575 only. The remaining messages beginning at S 2.23 are for both the 565/575.</p>		
S 2.15	<div style="border: 1px solid black; padding: 5px;"> PH AUTOBLK INST HISET DISABLED </div>	<p>This setpoint allows the user to enable or disable the phase autoblock HISET feature.</p>
<p>Message S 2.16 will only appear if ENABLED is selected in message S 2.15.</p>		
S 2.16	<div style="border: 1px solid black; padding: 5px;"> PH AUTOBLK HISET AFTER RECL.# 4 </div>	<p>Determined after which reclosure the Phase Instantaneous Hiset Trip will be disabled (blocked).</p>
S 2.17	<div style="border: 1px solid black; padding: 5px;"> PHASE LOSET INST TRIPS ENABLED </div>	<p>Same as PHASE HISET INST TRIP feature except any two phases must be over the trip level to cause a trip.</p>
<p>Messages S 2.18 to S 2.22 will only appear if ENABLED is selected in message S 2.17.</p>		
S 2.18	<div style="border: 1px solid black; padding: 5px;"> PHASE LOSET INST TRIPS 2.0 X P/U </div>	<p>Similar to PHASE HISET INST TRIP feature (see above).</p>
S 2.19	<div style="border: 1px solid black; padding: 5px;"> PHASE LOSET INST DELAY INST </div>	<p>Similar to PHASE HISET INST TRIP feature (see above).</p>
S 2.20	<div style="border: 1px solid black; padding: 5px;"> PHASE LOSET INST RELAY TRIP&AUX1 </div>	<p>Select the desired output contact(s) to activate on a PHASE LOSET INST TRIP.</p>
S 2.21	<div style="border: 1px solid black; padding: 5px;"> PH AUTOBLK INST LOSET DISABLED </div>	<p>This setpoint allows the user to enable or disable the phase autoblock LOSET feature.</p>

Location	Message Line	Description
----------	--------------	-------------

Message S 2.22 will only appear if ENABLED is selected in message S 2.21.

S 2.22	<pre>PH AUTOBLK LOSET AFTER RECL.# 4</pre>	Determines after which reclosure the PHASE LOSET INST TRIP will be disabled (blocked).
--------	--	--

Messages S 2.23 and S 2.24 will only appear if CUSTOM CURVE1 was selected in message S 2.4.

S 2.23	<pre>TRIP TIME (SEC) 1.03 xPU= 1.0</pre>	<p>The programmable curve for the phase overcurrent protection is set up in the following messages. The trip time for the first breakpoint is requested here. There are 79 breakpoints in total, each corresponding to a multiple of the pickup current. A time to trip must be entered for each breakpoint, in the range of 0.1 seconds to 1092.2 seconds in steps of 0.1 second. Determine the required times by referring to the system plot. In the following messages the trip times are entered for each multiple of the pickup current in these ranges:</p> <p>a) 1.03, and 1.1 to 5.9 in steps of 0.1. b) 6.0 to 20.0 in steps of 0.5.</p> <p>All the values in these ranges will appear in the following messages automatically as the LINE DOWN key is pressed. As each message appears, enter the time to trip for current represented by this multiple of pickup current, and store the value. When the LINE DOWN is pressed, the message with the next increment of pickup current multiplier will appear until a multiplier of 20.0 is reached as shown in message S 2.16. The intermediate messages are in the same format and are not shown. When a time multiplier of 20 is reached, pressing the LINE DOWN key will cause the display to return to message S 2.15. When finished entering values, press the PAGE key to view setpoints page 3.</p>
L _A		

S 2.24	<pre>TRIP TIME (SEC) 20.0 xPU= 1.0</pre>	The trip time for the last breakpoint, 20 times the pickup level, is entered here. The Custom Curve should not be programmed with uphill specs since no positive slopes are maintained.
--------	--	---

S 2.25	<pre>PHASE CURRENT END OF PAGE</pre>	This is the last line of page 2 Setpoints when the custom curve is not selected as the overcurrent curve shape. Press PAGE to view page 3.
--------	--------------------------------------	--

SETPOINTS MODE - GROUND CURRENT



Location	Message Line	Description
S 3.1	<div style="border: 1px solid black; padding: 5px; text-align: center;"> SETPOINTS GROUND CURRENT </div>	The setpoints page 3 header. In this page the setpoints which determine the ground current protection are entered.

S 3.2	<div style="border: 1px solid black; padding: 5px; text-align: center;"> GROUND CURRENT SENSING ENABLED </div>	This message allows the user to enable or disable the Ground Current protection.
-------	--	--

Only message S 3.19 will appear if DISABLED is selected in message S 3.2.

S 3.3	<div style="border: 1px solid black; padding: 5px; text-align: center;"> SENSING SYSTEM RESIDUAL </div>	This message is asking if your system uses a separate zero sequence CT or if the phase CT's are connected in a residual sensing configuration to detect ground currents. Either RESIDUAL or ZERO SEQ can be selected. Select the one corresponding to your sensing system.
-------	---	--

Message S 3.4 will only appear if ZERO SEQ was selected in Message S 3.3.

S 3.4	<div style="border: 1px solid black; padding: 5px; text-align: center;"> CT RATIO PRIMARY 100 A </div>	This message asks for the primary ratio of the zero sequence transformer being used in your application. The range of values for this setpoint is 10 to 5000 in steps of 5 Amp. This value will be on the transformer nameplate.
-------	--	--

S 3.5	<div style="border: 1px solid black; padding: 5px; text-align: center;"> GROUND TIMED O/C PICKUP 40% CT </div>	The ground overcurrent pickup level is entered here as a percentage of the CT rating. The range of values allowed is 5% to 150% in steps of 1%. This setpoint sets the level of current at which the 565 Relay initiates a timed trip of the feeder breaker according to the curve selected in message S 3.6.
-------	--	---

For example, if 50% is entered here, then the 565/575 Relay will initiate a programmed trip of the feeder breaker when the ground current reaches 50% of the full CT rating. The CT rating used will be either:

- 1) The phase CT primary rating entered in message S 2.2, if residual current sensing is chosen in message S 3.3.
- 2) The zero sequence CT primary rating, if zero sequence sensing is chosen in message S 3.3.

If the ground current exceeds the limits of the Time/Overcurrent curve in use, a feeder breaker trip will occur. Determine the ground current pickup level for your application according to the grounding system used.

S 3.6	<div style="border: 1px solid black; padding: 5px; text-align: center;"> GND O/C CURVE SHAPE : EXTREM INV </div>	The shape of the required ground current protection curve must be entered here. The available curves are shown below, together with the shortened form of the name which is displayed in the message.
-------	--	---

CURVE NAME	DISPLAYED NAME
1. Moderately Inverse	MOD INV.
2. Normal Inverse	NORMAL INV.
3. Very Inverse	VERY INV.
4. Extremely Inverse	EXTREM INV.
5. Custom Curve	CUSTOM.
6. IEC	IEC A
7. IEC	IEC B
8. IEC	IEC C

Location	Message Line	Description
<i>Message S 3.7 will not appear if CUSTOM CURVE is selected in message S 3.6.</i>		
S 3.7	GROUND O/C TIME DIAL 1	The ground overcurrent time dial number is entered here. This allows the user to select a curve to match the system requirements. Refer to the "Use of standard curves" in section 3 to determine the correct curve and select it by entering its number here. Any number between 1 and 32 may be entered.
S 3.8	GROUND O/C RELAY TRIP	This message allows the user to select the relay which the ground overcurrent trip will activate.
S 3.9	GROUND O/C ALARM DISABLED	This message asks if you want the ground overcurrent alarm ENABLED or DISABLED.
L _A		
<i>Messages S 3.10 to 3.12 will only appear if ENABLED is selected in message S 3.9.</i>		
S 3.10	GND O/C ALARM LEVEL 1.5 X P/U	The ground overcurrent alarm level is entered here as a multiple of the pickup level. The range of values allowed is 0.5 to 3 in steps of 0.1. This setpoint sets the level of ground current at which the 565 Relay initiates an alarm. A level of 1 times pickup can be programmed. The LCD will then indicate when the Relay is operating above pickup.
L _A		
S 3.11	GND O/C ALARM DELAY 1 SEC	The time delay for the ground alarm is entered here. This feature prevents the alarm for the timed period and stops nuisance alarms due to momentary high ground currents. Should the alarm condition persist beyond the timed period the alarm will occur. The range for this setpoint is 1 to 255 seconds in steps of 1 second.
L _A		
S 3.12	GND O/C ALARM RELAY AUX1	This message allows the user to select the relay which the alarm signal generated in message S 3.10 will activate.
L _A		
S 3.13	GROUND INST TRIPS ENABLED	This message asks if you want the ground instantaneous trip ENABLED or DISABLED.
(575)	GND HISET INST TRIPS ENABLED	NOTE: This setpoint must be enabled and a proper trip level must be selected if a pickup level has been selected greater than 100% of CT (5A tap only). See caution in section "Protection Application Information."
<i>Messages S 3.14 to 3.16 will only appear if ENABLED is selected in message S 3.13.</i>		
S 3.14	GND HISET TRIP LEVEL 3.0 X P/U	The instantaneous ground current trip level is entered here as a multiple of the pickup level already chosen in message S 3.5. This feature protects the feeder from sudden very high ground current. For example, say the ground pickup level is 50 amps, and a setting of 2 was chosen here. If a ground current of 100 or more amps lasts for longer than the time delay set in message S 3.15, then a trip signal will be produced by the 565 Relay. The range of the ground current protection will be set by the value of the ground overcurrent pickup level. In addition, the pickup level selects the appropri-
(575)	GND HISET INST TRIP 3.0 X P/U	

SETPOINTS MODE - GROUND CURRENT



Location	Message Line	Description
----------	--------------	-------------

ate Ground Instantaneous Trip Level setpoint.

If a Ground Overcurrent Pickup Level is selected between 5 and 24%, the range of the ground protection will be from 1 to 8 times pickup. As a result, the Ground Instantaneous Trip Level setpoint at address 138_{HEX} will appear. With this setpoint, instantaneous trip levels will be selectable from 1 to 7 times pickup in steps of 0.1. The setpoint message will appear as above.

If a Ground Overcurrent Pickup Level is selected between 25 and 150%, the range of the ground protection will be from 1 to 20 times pickup. As a result, the Ground Instantaneous Trip Level setpoint at address 145_{HEX} will appear. With this setpoint, instantaneous trip levels will be selectable from 1 to 18 times pickup in steps of 0.1. The setpoint message will appear as below. (The preceding discussion addresses the Ground Current Autoranging feature.)

```
GND INST TRIP 2
LEVEL 3.0 X P/U
```

S 3.15	GND INST TRIP DELAY INST
	GND HISET INST DELAY INST

(575)

An intentional delay on the ground instantaneous trip is entered here, in the range of 0 to 40 cycles, in steps of 1 cycle. This prevents nuisance trips due to momentary high ground currents. Should the condition persist beyond the timed period the trip will occur. If 0 is selected, the message will display INST and there will be no intentional delay on the trip. There is, however, a 1 cyc delay which is necessary for the 565 relay to react to the fault condition. If any other value is entered within the above range, the trip will occur in the above reaction time plus the entered value.

Definite Time characteristics can be implemented by using the ground instantaneous trip and the appropriate time delays. For example, the ground instantaneous trip can be enabled and a delay between 0–40 cycles programmed. This effectively will simulate a Definite Time curve.

S 3.16	GND HISET TRIP RELAY TRIP
	GND HISET INST RELAY TRIP&AUX1

(575)

This message allows the user to select the relay which the trip signal generated in message S 3.14, will activate.

Messages S 3.17 to S 3.24 are specific to the 575 only. The remaining messages beginning with S 3.25 are for both the 565/575.

S 3.17	GND AUTOBLK INST HISET DISABLED
--------	------------------------------------

This setpoint allows the user to enable or disable the ground autoblock hiset feature.

Message S 3.18 will only appear if ENABLED is selected in message S 3.17.

S 3.18	GND AUTOBLK HISET AFTER RECL.# 4
--------	-------------------------------------

The GND HISET TRIP will be blocked after the selected reclosure shot.

Location	Message Line	Description
S 3.19	GND LOSET INST TRIPS ENABLED	Set to ENABLED to enable loset ground element.
<i>Messages S 3.20 to S 3.24 will only appear if ENABLED is selected in message S 3.19.</i>		
S 3.20	GND LOSET INST TRIP 2.0 X P/U	Same as GND HISET INST TRIP feature. Range: 1.0–7.0, increments of 0.5.
S 3.21	GND LOSET INST DELAY INST	Same as GND HISET INST TRIP DELAY. Range: 0–40 cycles.
S 3.22	GND LOSET INST RELAY TRIP&AUX1	Select the desired output contact(s) to activate on a GND LOSET INST trip.
S 3.23	GND AUTOBLK INST LOSET DISABLED	This setpoint allows the user to enable or disable the ground autoblock loset feature.
<i>Message S 3.24 will only appear if ENABLED is selected in message S 3.23.</i>		
S 3.24	GND AUTOBLK LOSET AFTER RECL.# 4	The G/F LOSET INST TRIP will be blocked after the selected reclosure shot.
<i>Messages S 3.25 and 3.26 will only appear if CUSTOM CURVE1 was selected in message S 3.6.</i>		
S 3.25 L _A	TRIP TIME (SEC) 1.03 xPU= 1.0	The trip time for the first breakpoint of the programmable curve for ground current protection is entered here. The breakpoints are multiples of the pickup current.
<i>The remainder of the messages in this section are identical to those in the phase current programmable curve setup. Follow all the same steps until message S 3.18 appears. When the time for this multiple of pickup is entered and stored, pressing the PAGE key will cause the display to move to the next page of setpoints mode.</i>		
<i>NOTE: When the overload is greater than eight times pickup, the 575 will cause a Ground Timed Overcurrent Trip in the time programmed for an eight times overload. This is regardless of how the Custom Curve is programmed for overloads greater than eight times pickup.</i>		
S 3.26 L _A	TRIP TIME (SEC) 20.0 xPU= 1.0	The trip time for the last breakpoint, a current of 20 times the pickup level is entered here.
S 3.27	GROUND CURRENT END OF PAGE	The last line of page 3, setpoints. Press the PAGE key to view page 4.

SETPOINTS MODE - CONFIGURATION



Location	Message Line	Description										
S 4.1	SETPOINTS CONFIGURATION	The setpoints page 4 header. In this page, switch and relay characteristics are set up to suit the particular application. These switch inputs are provided on the 565 Relay back panel to accept external signals for customer use. The use of switches 1 to 8 is user definable. External switches can have either normally open (N.O) or normally closed (N.C) contacts. A normally open switch will have its contacts in the open (non-conducting) state under inactive conditions. Similarly, a normally closed switch will have its contacts closed (conducting) in the inactive state. This information must be given to the 565 Relay if it is to use these inputs. Other features such as the time and date are also setup on this page.										
S 4.2	SET hh:mm:ss TIME 13:33:10	<p>The current time must be entered here in the following format:</p> <p>Hour:Minute:Second</p> <p>For example if the time is 33 minutes and 10 seconds past one in the afternoon, it would be entered as:</p> <p>13:33:10</p> <p>This time setting will not be lost if power supply to the 565 Relay is interrupted, because a lithium battery maintains the real time clock.</p>										
S 4.3	SET mm/dd/yy DATE AUG 04,1992	<p>The current date must be entered in this message. The Relay will use this to keep a record of when trips occurred. The date setting is laid out in the following form:</p> <p>Month:Day:Year</p> <p>For example, if the date is the 4th of August 1992 then the following data would be entered:</p> <p>08:04:92</p>										
S 4.4 L _A	RESET BLOCKED DISABLED	<p>This message allows the user to assign an external switch to the reset lockout function. This function assignment means that when the appropriate switch is active, it will stop a reset from occurring. This function can be used to provide an "interlock". For example, it could be used to prevent a breaker closure after a trip without permission from a remote source.</p> <p>Select the intended switch for the function, using the NEXT CHOICE key. The switch choices are:</p> <table><tbody><tr><td>1) DISABLED</td><td>6) SW.5</td></tr><tr><td>2) SW.1</td><td>7) SW.6</td></tr><tr><td>3) SW.2</td><td>8) SW.7</td></tr><tr><td>4) SW.3</td><td>9) SW.8</td></tr><tr><td>5) SW.4</td><td></td></tr></tbody></table> <p>The complete list of function/switch setpoints is shown as follows:</p>	1) DISABLED	6) SW.5	2) SW.1	7) SW.6	3) SW.2	8) SW.7	4) SW.3	9) SW.8	5) SW.4	
1) DISABLED	6) SW.5											
2) SW.1	7) SW.6											
3) SW.2	8) SW.7											
4) SW.3	9) SW.8											
5) SW.4												
S 4.5 L _A	BLOCK INST TRIPS DISABLED	This setpoint will stop an instantaneous trip from occurring when the switch is active.										
S 4.6 L _A	BLOCK TIMED O/C TRIPS DISABLED	If a switch is assigned this function it will stop all timed overcurrent trips when the switch is active.										

Location	Message Line	Description
S 4.7	BLOCK GND TRIPS DISABLED	If this function is assigned, all ground tripping is blocked for the length of time the external switch is active.
S 4.8 L _A	DEFINITE TIME #1 ALARM DISABLED	This function will assign a time delayed alarm to the selected switch. The switch will then have to be held active for the programmed delay time before an alarm occurs.

Message S 4.9 and S 4.10 will only appear if the Definite Time function in message S 4.8 is assigned to a switch.

S 4.9 L _A	DEFINITE TIME #1 DELAY 1 SEC	This message asks for any time delay needed on the operation of the switch. This means that if one of the internal relays is to be energized by this switch it will only be energized if the switch is activated for the assigned time. The range for this setpoint is 1 to 255 seconds, in steps of 1 second.
-------------------------	---------------------------------	--

S 4.10 L _A	DEFINITE TIME #1 RELAY AUX2	The switch being configured can be used to activate one of the internal relays in the 565 Relay. This message is asking you to select the relay or relays which the definite time function will activate. There are two relays to which the signal can be sent, called Aux.1 and 2. See Relay selection section for details of how to make this selection.
--------------------------	--------------------------------	--

S 4.11 L _A	DEFINITE TIME #2 ALARM DISABLED	This function will assign a time delayed alarm to the selected switch. The switch will then have to be held active for the programmed delay time before an alarm occurs.
--------------------------	------------------------------------	--

Messages S 4.12 and S 4.13 will only appear if the Definite Time function in message S 4.11 is assigned to a switch.

S 4.12 L _A	DEFINITE TIME #2 DELAY 1 SEC	Enter the amount of time the above switch must be active before an alarm will occur.
--------------------------	---------------------------------	--

S 4.13 L _A	DEFINITE TIME #2 RELAY AUX2	Enter which output relay will activate when the above alarm occurs.
--------------------------	--------------------------------	---

S 4.14 L _A	EXTERNAL TRIP #1 DISABLED	If this function is assigned to a switch then it will cause the input to act as an external trip for the feeder breaker. External trip devices are called "3T" devices.
--------------------------	------------------------------	---

(575)	EXTERNAL TRIP DISABLED
-------	---------------------------

Messages S 4.15 and S 4.16 will appear only if the External Trip function in message S 4.14 is assigned to a switch.

S 4.15 L _A	EXTERNAL TRIP #1 RELAY TRIP&AUX1	Enter which output relay will activate when the above trip occurs.
--------------------------	-------------------------------------	--

(575)	EXTERNAL TRIP RELAY TRIP&AUX1
-------	----------------------------------

SETPOINTS MODE - CONFIGURATION



Location	Message Line	Description
----------	--------------	-------------

The following are messages specific to the 565; messages specific to the 575 will be indicated as required.

S 4.16	<pre>EXTERNAL TRIP #1 DELAY 0 CYC</pre>	This message asks for any time delay needed on the operation of the switch. This means that if one of the internal relays is to be energized by this switch it will only be energized if the switch is activated for the assigned time. The range for this setpoint is 0 (Inst.) to 60 cycles, in steps of 1 cycle.
--------	--	---

S 4.17	<pre>EXTERNAL TRIP #2 DISABLED</pre>	If this function is assigned to a switch then it will cause the input to act as an external trip for the feeder breaker.
--------	--------------------------------------	--

Message S 4.18 and S 4.19 will appear only if the External Trip function in message S 4.17 is assigned to a switch.

S 4.18	<pre>EXTERNAL TRIP #2 RELAY TRIP&AUX1</pre>	Enter which output relay will activate when the above trip occurs.
--------	---	--

S 4.19	<pre>EXTERNAL TRIP #2 DELAY 0 CYC</pre>	This message asks for any time delay needed on the operation of the switch. This means that if one of the internal relays is to be energized by this switch it will only be energized if the switch is activated for the assigned time. The range for this setpoint is 0 (Inst.) to 60 cycles, in steps of 1 cycle.
--------	--	---

S 4.20	<pre>EXTERNAL TRIP #3 DISABLED</pre>	If this function is assigned to a switch then it will cause the input to act as an external trip for the feeder breaker.
--------	--------------------------------------	--

Message S 4.21 and S 4.22 will appear only if the External Trip function in message S 4.20 is assigned to a switch.

S 4.21	<pre>EXTERNAL TRIP #3 RELAY TRIP&AUX1</pre>	Enter which output relay will activate when the above trip occurs.
--------	---	--

S 4.22	<pre>EXTERNAL TRIP #3 DELAY 0 CYC</pre>	This message asks for any time delay needed on the operation of the switch. This means that if one of the internal relays is to be energized by this switch it will only be energized if the switch is activated for the assigned time. The range for this setpoint is 0 (Inst.) to 60 cycles, in steps of 1 cycle.
--------	--	---

S 4.23	<pre>EXTERNAL TRIP #4 DISABLED</pre>	If this function is assigned to a switch then it will cause the input to act as an external trip for the feeder breaker.
--------	--------------------------------------	--

Messages S 4.24 and S 4.25 will appear only if the External Trip function in message S 4.23 is assigned to a switch.

S 4.24	<pre>EXTERNAL TRIP #4 RELAY TRIP&AUX1</pre>	Enter which output relay will activate when the above trip occurs.
--------	---	--

S 4.25	<pre>EXTERNAL TRIP #4 DELAY 0 CYC</pre>	This message asks for any time delay needed on the operation of the switch. This means that if one of the internal relays is to be energized by this switch it will only be energized if the switch is activated for the assigned time. The range for this setpoint is 0 (Inst.) to 60 cycles, in steps of 1 cycle.
--------	--	---

S 4.26	<pre>CURVE ADJUSTMENT DISABLED</pre>	If an external switch is assigned this function then the timed overcurrent curve in use will not start to time out until the current is above pickup by 10%. Essentially, the bottom part of the curve that falls between 100 and 110% disappears, yet the time to trip above this level would remain the same.
--------	--------------------------------------	---

Location	Message Line	Description
<i>The following messages pertain to the 575.</i>		
S 4.16	<div style="border: 1px solid black; padding: 5px; text-align: center;"> RECLOSABLE TRIP DISABLED </div>	This function will provide an instantaneous trip that will allow the reclosing scheme to initiate/continue through the reclosure.
<i>Message S 4.17 will appear only if the Reclosable Trip function in message S 4.16 is assigned to a switch.</i>		
S 4.17	<div style="border: 1px solid black; padding: 5px; text-align: center;"> RECLOSABLE TRIP RELAY TRIP&AUX1 </div>	Enter which output relay will activate when the above trip occurs.
S 4.18	<div style="border: 1px solid black; padding: 5px; text-align: center;"> PROGRAMMABLE TRIP DISABLED </div>	This function will provide an instantaneous trip that will or will not allow the reclosing scheme to initiate/continue depending on setpoint S 4.20.
<i>Messages S 4.19 and S 4.20 will only appear if the Programmable Trip function in message S 4.18 is assigned to a switch.</i>		
S 4.19	<div style="border: 1px solid black; padding: 5px; text-align: center;"> PROGRAMMABLE TRIP RELAY TRIP&AUX1 </div>	Enter which output relay(s) will activate when the above trip occurs.
S 4.20	<div style="border: 1px solid black; padding: 5px; text-align: center;"> PROGRAMMABLE TRIP TYPE NON-RECLS </div>	This setpoint allows you to define this function to allow the reclosing scheme to initiate/continue or go straight to lockout.
S 4.21	<div style="border: 1px solid black; padding: 5px; text-align: center;"> CURVE ADJUSTMENT DISABLED </div>	If an external switch is assigned this function then the timed overcurrent curve in use will not start to time out until the current is above pickup by 10%. Essentially, the bottom part of the curve that falls between 100 and 110% disappears, yet the time to trip above this level would remain the same.
S 4.22	<div style="border: 1px solid black; padding: 5px; text-align: center;"> ALTERNATE PHASE CURVE DISABLED </div>	This function will switch the phase overcurrent curve to an alternative programmed curve after the specified autoreclosure shot if the assigned switch is active. Curve 1 is restored once autoreclosure reaches lockout or the scheme resets. This curve changeover will occur automatically if phase curve change is enabled in message S 13.2.
S 4.23	<div style="border: 1px solid black; padding: 5px; text-align: center;"> ALTERNATE GROUND CURVE DISABLED </div>	This function is the same as described above except it acts upon the ground overcurrent curve.
S 4.24	<div style="border: 1px solid black; padding: 5px; text-align: center;"> AUTO-RECLOSURE BLOCK DISABLED </div>	When active, all reclosures are blocked.
S 4.25 (565/575)	<div style="border: 1px solid black; padding: 5px; text-align: center;"> EXTERNAL RESET DISABLED </div>	This input operates just as the front RESET key would operate.
S 4.26 (565/575)	<div style="border: 1px solid black; padding: 5px; text-align: center;"> SW.1 CONTACT: NORMALLY OPEN </div>	This message allows the contact sense of the selected switch to be entered into the 565 Relay's memory. Determine whether the switch is normally open or normally closed from the manufacturer's data or system wiring diagram.
When switch 1 contact sense has been assigned, message S 4.28 will repeat for switches 2 through 8.		

SETPOINTS MODE - CONFIGURATION



Location Message Line Description

S 4.27	TRIP RELAY PULSED
(565)	
	AUX 1 RELAY PULSED
(575)	

This display indicates that the Trip relay is ready to have its mode of operation set up. This controls whether the relay will operate in a pulsed or latched mode, as follows:

Pulsed Operation

If pulsed operation is selected, the Trip relay is energized and the pulse timer is initiated upon a trip declaration. If the fault current drops below pick up before the pulse timer expires, this is taken as an indication that the breaker has opened successfully. In this case, the Trip relay will become de-energized when the pulse time does expire. Note that this pulse time, which is programmed in message S4.30, will be the minimum amount of time that the Trip relay will remain energized. On the other hand, if the pulse timer expires before the fault current drops below pick up, the relay will remain energized. When the fault current eventually drops below pick up, the 565 seal-in timer is initiated. After this 2.5 - 3.5 cycle seal-in delay elapses, the Trip relay de-energizes.

NOTE: The 565 relays are not designed to regularly break inductive current. Pulsed relay becomes latched to act as the seal-in contact as used in electromechanical relays.

CONDITION	OUTPUT TRIP RELAY	FACEPLATE TRIP LED	MODBUS READ EXCEPTION STATUS
NO TRIP	DE-ENERGIZED	OFF	00H
TRIPPED (Current > P/U)	ENERGIZED	ON	88H
TRIPPED (Current < P/U)	DE-ENERGIZED	FLASHING	08H
KEYPAD RESET	DE-ENERGIZED	OFF	00H

Latched Operation

If latched operation is chosen for the Trip relay, it will energize when a trip occurs. Pressing the RESET key on the front panel will unlatch the Trip relay only if the current is below the programmed trip level. This may be convenient if the relay is being used to annunciate a fault condition.

CONDITION	OUTPUT TRIP RELAY	FACEPLATE TRIP LED	MODBUS READ EXCEPTION STATUS
NO TRIP	DE-ENERGIZED	OFF	00H
TRIPPED (Current > Trip Level)	ENERGIZED	ON	88H
TRIPPED (Current < Trip Level)	ENERGIZED	ON	88H
KEYPAD RESET	DE-ENERGIZED	OFF	00H

Message S 4.28 will only appear if pulsed operation is assigned to the Trip relay.

S 4.28	TRIP RELAY PULSE TIME 0.6 SEC
(565)	

This message allows the user to set the length of the pulse for the Trip relay when selected for pulse operation. The pulse time controls the minimum length of time that the relay will be energized. The range of values for this setpoint is 0.1 to 0.6 seconds in steps of 0.1 seconds.

NOTE: The 565 Trip relay does not look at the status of the 52a/52b

Location	Message Line	Description
----------	--------------	-------------

contacts.

Message S 4.29 will only appear if pulsed operation is assigned to the Aux. 1 relay.

S 4.29 (575)	<div style="border: 1px solid black; padding: 5px;"> AUX1 RELAY PULSE TIME 0.1 SEC </div>	This message allows the user to set the length of the pulse for the Trip relay when selected for pulse operation. The pulse time controls the minimum length of time that the relay will be energized. The range of values for this setpoint is 0.1 to 0.6 seconds in steps of 0.1 seconds. Aux. 1 will act as Trip Annunciate with Trip & Aux. 1 acting together when a trip function is programmed to Trip & Aux. 1.
-----------------	--	--

S 4.30 (575)	<div style="border: 1px solid black; padding: 5px;"> AUX 2 RELAY UNLATCHED </div>	As with the Aux. 1 relay, this setpoint allows the mode of operation for the Aux. 2 relay to be selected. The available modes are pulsed, latched or unlatched.
-----------------	--	---

S 4.31 (565)	<div style="border: 1px solid black; padding: 5px;"> AUX 1 RELAY UNLATCHED </div>	This setpoint allows the user to select the mode of operation for the Aux 1 relay. The available modes are pulsed, latched, or unlatched. If the Aux 1 relay is programmed as pulsed, only trip conditions should be assigned to it. When programmed in this pulsed mode, Aux 1 is intended to be used as a trip follower. Alarm conditions assigned to a pulsed Aux 1 will only reset if the breaker is open.
-----------------	--	--

Pulsed Operation

If pulsed operation is selected, the Aux 1 relay is energized and the pulse timer is initiated upon a trip/alarm declaration. In order for the 565 to determine that the breaker has opened successfully, two conditions must be met. First, the fault current must be below pick up. Secondly, either the 52a contact must be detected as open or the 52b contact must be detected as closed. When this happens before the pulse timer expires, the Aux 1 relay will become de-energized when the pulse time does expire. Note that this pulse time which is programmed in message S4.32 will be the minimum amount of time that the trip relay will remain energized. On the other hand, if the pulse timer expires before the fault current drops below pick up and the 52a/52b contacts respond, the relay will remain energized. When these two conditions eventually occur, the 565 seal-in timer is initiated. After this 2.5 - 3.5 cycle seal-in delay elapses, the Aux 1 relay de-energizes.

CONDITION	OUTPUT AUX. 1 RELAY	FACEPLATE AUX. 1 LED	MODBUS READ EXCEPTION STATUS
NO TRIP	DE-ENERGIZED	OFF	00H
TRIPPED (Current > P/U)	ENERGIZED	ON	44H
TRIPPED (Current < P/U) (Brkr. Open)	DE-ENERGIZED	FLASHING	04H
KEYPAD RESET	DE-ENERGIZED	OFF	00H

SETPOINTS MODE - CONFIGURATION



Location Message Line Description

CONDITION	OUTPUT AUX. 1 RELAY	FACEPLATE AUX. 1 LED	MODBUS READ EXCEPTION STATUS
NO ALARM	DE-ENERGIZED	OFF	00H
ALARM (Alarm Level < Curr. < P/U) (Brkr. Open)	PULSES	ON	40H
ALARM (Curr. > Alarm & P/U Level)	ENERGIZED	OFF	40H
ALARM (Curr. < Alarm & P/U Level) (Brkr. Open)	DE-ENERGIZED	OFF	00H
KEYPAD RESET	DE-ENERGIZED	OFF	00H

Latched

If latched operation is chosen for the Aux 1 relay, it will energize when a trip/alarm occurs. Pressing the RESET key on the front panel will unlatch the Aux 1 relay only if the fault current is below the trip/alarm level. This may be convenient if the relay is being used to annunciate a fault condition. When programmed as latched, the Aux 1 relay does not look at the 52a/52b contacts.

CONDITION	OUTPUT AUX. 1 RELAY	FACEPLATE AUX. 1 LED	MODBUS READ EXCEPTION STATUS
NO TRIP	DE-ENERGIZED	OFF	00H
TRIPPED (Current > Trip Level)	ENERGIZED	ON	44H
TRIPPED (Current < Trip Level)	ENERGIZED	ON	44H
KEYPAD RESET	DE-ENERGIZED	OFF	00H

CONDITION	OUTPUT AUX. 1 RELAY	FACEPLATE AUX. 1 LED	MODBUS READ EXCEPTION STATUS
NO ALARM	DE-ENERGIZED	OFF	00H
ALARM (Current > Alarm Level)	ENERGIZED	ON	40H
ALARM (Current < Alarm Level)	ENERGIZED	ON	40H
KEYPAD RESET	DE-ENERGIZED	OFF	00H

Unlatched

If unlatched operation is selected, the Aux 1 relay becomes energized upon declaration of a fault/ alarm condition. When current drops below the alarm/trip level, the relay will de-energize. When programmed as unlatched, the Aux 1 relay does not look at the 52a/52b contacts.

Location Message Line Description

CONDITION	OUTPUT AUX. 1 RELAY	FACEPLATE AUX. 1 LED	MODBUS READ EXCEPTION STATUS
NO TRIP	DE-ENERGIZED	OFF	00H
TRIPPED (Current > Trip Level)	ENERGIZED	ON	44H
TRIPPED (Current < Trip Level)	DE-ENERGIZED	FLASHING	04H
KEYPAD RESET	DE-ENERGIZED	OFF	00H

CONDITION	OUTPUT AUX. 1 RELAY	FACEPLATE AUX. 1 LED	MODBUS READ EXCEPTION STATUS
NO ALARM	DE-ENERGIZED	OFF	00H
ALARM (Current > Alarm Level)	ENERGIZED	ON	40H
ALARM (Current < Alarm Level)	DE-ENERGIZED	OFF	00H
KEYPAD RESET	DE-ENERGIZED	OFF	00H

Message S4.32 will only appear if pulsed operation is assigned to the Aux 1 relay.

S 4.32

(565)

AUX1 RELAY PULSE TIME 0.6 SEC

This message allows the user to set the length of the pulse for the Aux 1 relay when selected for pulse operation. The pulse time controls the minimum length of time that the relay will be energized. The range of values for this setpoint is 0.1 to 0.6 seconds in steps of 0.1 seconds.

Message S4.33 will only appear if pulsed operation is assigned to the Aux . 2 relay.

S 4.33

(575)

AUX2 RELAY PULSE TIME 0.6 SEC

As with the Aux. 1 relay, this message allows the user to set the length of the pulse for the Aux. 2 relay.

S 4.34

AUX 2 RELAY UNLATCHED

This setpoint allows the user to select the mode of operation for the Aux 2 relay. The available modes are pulsed, latched or unlatched. The Aux 2 relay does not look at the 52a/52b contacts. **If the Aux 2 relay is programmed as pulsed, only alarm conditions should be assigned to it.**

Pulsed Operation

If pulsed operation is selected and a fault condition develops, the Aux 2 relay is energized and de-energized repeatedly. The rate at which the Aux 2 relay toggles is determined by the Aux 2 relay pulse timer setpoint S 4.34. Only when the fault current drops below pick up will Aux 2 relay stop pulsating.

SETPOINTS MODE - CONFIGURATION



Location Message Line Description

CONDITION	OUTPUT AUX. 2 RELAY	FACEPLATE AUX. 2 LED	MODBUS READ EXCEPTION STATUS
NO TRIP	DE-ENERGIZED	OFF	00H
TRIPPED (Current > P/U)	PULSES	ON	22H
TRIPPED (Current < P/U)	DE-ENERGIZED	FLASHING	02H
KEYPAD RESET	DE-ENERGIZED	OFF	00H

CONDITION	OUTPUT AUX. 2 RELAY	FACEPLATE AUX. 2 LED	MODBUS READ EXCEPTION STATUS
NO ALARM	DE-ENERGIZED	OFF	00H
ALARM (Current > Alarm Level)	PULSES	ON	20H
ALARM (Current < Alarm Level)	DE-ENERGIZED	OFF	00H
KEYPAD RESET	DE-ENERGIZED	OFF	00H

Latched

If latched operation is chosen for the Aux 2 relay, it will energize when a trip occurs. Pressing the RESET key on the front panel will unlatch the Aux 2 relay only if the fault current is below pick up. This may be convenient if the relay is being used to annunciate a fault condition.

CONDITION	OUTPUT AUX. 2 RELAY	FACEPLATE AUX. 2 LED	MODBUS READ EXCEPTION STATUS
NO TRIP	DE-ENERGIZED	OFF	00H
TRIPPED (Current > Trip Level)	ENERGIZED	ON	22H
TRIPPED (Current < Trip Level)	ENERGIZED	ON	22H
KEYPAD RESET	DE-ENERGIZED	OFF	00H

CONDITION	OUTPUT AUX. 2 RELAY	FACEPLATE AUX. 2 LED	MODBUS READ EXCEPTION STATUS
NO ALARM	DE-ENERGIZED	OFF	00H
ALARM (Current > Alarm Level)	ENERGIZED	ON	20H
ALARM (Current < Alarm Level)	ENERGIZED	ON	20H
KEYPAD RESET	DE-ENERGIZED	OFF	00H

Unlatched

If unlatched operation is selected, the Aux 2 relay becomes energized upon declaration of a fault condition. When current drops below pick up, the relay will de-energize.

Location Message Line Description

CONDITION	OUTPUT AUX. 1 RELAY	FACEPLATE AUX. 1 LED	MODBUS READ EXCEPTION STATUS
NO TRIP	DE-ENERGIZED	OFF	00H
TRIPPED (Current > Trip Level)	ENERGIZED	ON	22H
TRIPPED (Current < Trip Level)	DE-ENERGIZED	FLASHING	02H
KEYPAD RESET	DE-ENERGIZED	OFF	00H

CONDITION	OUTPUT AUX. 1 RELAY	FACEPLATE AUX. 1 LED	MODBUS READ EXCEPTION STATUS
NO ALARM	DE-ENERGIZED	OFF	00H
ALARM (Current > Alarm Level)	ENERGIZED	ON	20H
ALARM (Current < Alarm Level)	DE-ENERGIZED	OFF	00H
KEYPAD RESET	DE-ENERGIZED	OFF	00H

Message S4.34 will only appear if pulsed operation is assigned to the Aux 2 relay.

S 4.35

AUX2 RELAY PULSE TIME 0.6 SEC

This message allows the user to set the length of the pulse for the Aux 2 relay when selected for pulse operation. The pulse time controls the minimum length of time that the relay will be energized. The range of values for this setpoint is 0.1 to 0.6 seconds in steps of 0.1 seconds.

Note: The Auxiliary 3 relay is failsafe and designed to operate in an unlatched mode only. It is not programmable.

CONDITION	OUTPUT AUX. 3 RELAY	FACEPLATE AUX. 3 LED	MODBUS READ EXCEPTION STATUS
NO ALARM	ENERGIZED	OFF	00H
ALARM (Open Trip Coil)	DE-ENERGIZED	ON	10H
ALARM (Closed Trip Coil)	ENERGIZED	OFF	00H
KEYPAD RESET	ENERGIZED	OFF	00H

S 4.36

BREAKER RESPONSE DELAY 1 mS

This setpoint allows the user to enter the actual delay between the time when the trip contact closure is sent to the breaker and the opening of the breaker contacts. After the time delay specified, the 565/575 will begin to accumulate the KA² value of the breaker interruption. Determine this quantity from the breaker manufacturer's data of breaker opening time. The range of values which may be entered is 1 to 167 mS.

S 4.37

BREAKER DISCREP. (565) DISABLED

This message asks if you want the Breaker Discrepancy Alarm ENABLED or DISABLED (Aux4). This feature monitors the 52a and 52b breaker auxiliary contact and gives an alarm indication in two possible situations:

- a) The TRIP relay was activated but the breaker remained closed.

SETPOINTS MODE - CONFIGURATION



Location	Message Line	Description
		b) The CLOSE relay was activated but the breaker remained open. A breaker discrepancy causes the reclosure scheme to immediately lockout.
	OPTION NOT AVAILABLE	This message appears if ENABLED is selected in S 4.36 but the 565 does not have the option card installed.
<i>Message S 4.38 will only appear if enable is selected and stored in message S 4.36.</i>		
S 4.38	BREAKER DISCREP. DELAY 1000 mS	This setpoint defines the amount of time that the breaker has to clear a fault. If the 52b contact does not respond after this time, a Breaker Discrepancy Alarm occurs and Aux 4 output is activated.
S 4.39	TRIP COIL SUPERVISION DISABLED	This feature allows a small current to flow through the trip coil of the breaker to ensure it is continuous and the breaker will trip when called to do so. The function is only active when the breaker is closed. If the current flow is less than 0.8 mA, the failsafe Aux 3 relay will de-energize.
	OPTION NOT AVAILABLE	This message appears if ENABLED is selected in S 4.39 but the 565 does not have the option card installed.
S 4.40	ACCUMULATED KA ALARM DISABLED	This message asks if you want the accumulated KA ² alarm enabled or disabled.
<i>Messages S 4.40 and 4.41 will only appear if enable is selected and stored in message S 4.39.</i>		
S 4.41	ACCUMULATED KA ALARM 5000	The accumulated KA ² alarm level is entered here in the range of 5000 to 100000 in steps of 10. This accumulated value gives an indication of breaker pole wear and the alarm can be used to indicate when an inspection should occur.
S 4.42	KA ALARM RELAY AUX1	This message allows the user to select the relay which the alarm signal generated in message S 4.39 will activate.
S 4.43	EVENT RECORDING: ENABLED	This message allows the user to enable/disable the built in event recorder. The event recorder in the 575 will also recognize all events associated with autoreclosure. These include: trips, reclosures, alarms and lockout.
L _A	OPTION NOT AVAILABLE	This message appears if ENABLED is selected in S 4.43 but the 565 does not have the option card installed.
S 4.44	EVENT PRINTING: OFFLINE	This message allows users to choose whether to print events as they occur or not. If ONLINE is selected, each event is printed as it occurs.
L _A		
S 4.45	COLD LOAD P/U BLOCK LOSET	This setpoint allows the user to select whether LOWSET, HIGHSET, or BOTH types of instantaneous trips should be blocked after a manual breaker close.
L _A (575)		
S 4.45	COLD LOAD P/U DELAY 0.0 SEC	The time period after a manual breaker closure for which instantaneous phase and ground trips will be blocked is entered here. The range is 0 to 10 seconds in steps of 0.1 seconds. Entering a value of 0.0 disables this feature.
L _A		

Location	Message Line	Description
S 4.46	MTM COMM. : ENABLED	This message allows the user to enable or disable the Metering Transducer Module (MTM) communications. <i>** Available only with Option Card **</i>
S 4.47	CONFIGURATION END OF PAGE	The last line of page 4, setpoints. Press the PAGE key to view page 5.

SETPOINTS MODE - ANALOG INPUT



Location	Message Line	Description
S 5.1 L _A	SETPOINTS ANALOG INPUT	The setpoints page 5 header. This page allows the setpoints related to the analog input to be entered.
S 5.2 L _A	ANALOG INPUT: DISABLED	This message allows the user to enable or disable the analog input function.

Only message S 5.17 will appear if DISABLED is selected in message 5.2.

S 5.3 L _A	EDIT ANALOG INPUT TITLE? NO	This setpoint allows the user to enter any name of up to 16 characters, for the analog input. This name will then appear in the relevant displays. Use the NEXT CHOICE key to select YES and store this, if you intend to assign a name to the analog input.
-------------------------	--------------------------------	--

If YES is selected in message S 5.3, a brief description on how to store titles is displayed followed by message S 5.4.

S 5.4 L _A	__ USER TITLE	The display shows that the 565 Relay is ready to have the analog input name assigned. Press the LINE UP or LINE DOWN key to display each letter of the alphabet, one at a time. When the desired letter is displayed, press the NEXT CHOICE key to move the cursor to the next position. Repeat the same procedure for each additional letter of the title. Once the complete title is displayed, press the STORE key to save it in the 565 memory. After the STORE key has been pressed, the screen will return to message S 5.3.
-------------------------	---------------	--

S 5.5 L _A	EDIT ANALOG INPUT UNITS? NO	This setpoint allows the user to enter any name of up to 8 characters, for the analog input unit. This name will then appear in the relevant displays. Use the NEXT CHOICE key to select YES and store this, if you intend to assign a name to the analog input units.
-------------------------	--------------------------------	--

If YES is selected in message S 5.5 a brief description on how to store units is displayed followed by message S 5.6.

S 5.6 L _A	UNITS	This display appears when the 565 Relay is ready to have the analog input unit name assigned. Enter the required unit name, such as "DEG C" on the left hand side of the display, as described in message S 5.4. When the last character is displayed, press the STORE key to return to message S 5.5.
-------------------------	-------	--

S 5.7 L _A	MIN CURR SCALE VALUE: 4.00	The 565 Relay has the ability to accept an analog input signal in the range of 4-20 mA and this display asks for the scale factor which you intend to use for the minimum analog input.
-------------------------	-------------------------------	---

The quantity being monitored might be the temperature of a transformer on the feeder. This input can be used to initiate alarms if it exceeds safe levels. A scale factor can be chosen to change the displayed value from milliamps to degrees centigrade. The use of the minimum scale factor is shown by the following example. The 565 Relay logic is configured so that the value which you will see displayed when the analog signal is 4 mA will be the scale factor minimum value. Refer to the manufacturer's instructions for the monitor or device to determine the temperature (or other quantity) corresponding to its 4 mA output.

If this value is 50 degrees centigrade, for example, then set the minimum scale factor at 50. Now when a 4 mA input is presented to the 565 Relay it will display 50 indicating a temperature, which is more useful than a milliamp reading.

The range of possible values for the minimum scale factor is 0 to 1023 in

Location	Message Line	Description
		steps of 0.01. When the minimum scale factor has been set press STORE to place the value in the 565 memory.
S 5.8 L _A	<div style="border: 1px solid black; padding: 5px;"> MAX CURR SCALE VALUE: 20.00 </div>	<p>This display asks for the scale factor which you intend to use for the maximum analog input. In a similar way to the minimum scale factor, the maximum scale factor is used to set the value which will be displayed when the analog signal into the relay is 20 mA. Again, refer to the manufacturer's instructions for the monitor or device which you intend to use to determine the magnitude of the temperature (or other quantity) corresponding to its 20 mA output. Set the maximum scale value to this figure. Now, when a 20 mA input is presented to the 565 Relay it will display this figure, indicating a temperature for example, rather than a mA reading. The range of possible values for the maximum scale factor is 0 to 1023 in steps of 0.01.</p> <p>Once the minimum and maximum scale factors are set the 565 Relay logic will ensure that all milliamp values between these two will be linearly displayed.</p>
S 5.9 L _A	<div style="border: 1px solid black; padding: 5px;"> ANALOG INPUT TRIP DISABLED </div>	<p>This message allows the user to enable or disable analog input trips.</p>
<p><i>Messages S 5.10 to 5.12 will only appear if ENABLED is selected in message S 5.9</i></p>		
S 5.10 L _A	<div style="border: 1px solid black; padding: 5px;"> ANALOG IN TRIP 16.00 UNITS </div>	<p>This line allows the user to specify at what level of the input analog signal the 565 Relay will initiate a trip of the feeder breaker. The level must be entered within the range of the scaled values, see messages S 5.7 and 5.8. The units displayed here will be those entered in message S 5.6.</p>
S 5.11 L _A	<div style="border: 1px solid black; padding: 5px;"> ANALOG IN TRIP DELAY 1 SEC </div>	<p>The delay on the feeder breaker trip caused by the analog input is entered here, in the range of 1 to 255 seconds in steps of 1 second. This prevents nuisance trips due to momentary (normal) high levels. Should the condition persist beyond the timed period the trip will occur.</p>
S 5.12 L _A	<div style="border: 1px solid black; padding: 5px;"> ANALOG IN TRIP RELAY TRIP </div>	<p>This message allows the user to select the relay which the trip signal generated in message S 5.9, will activate.</p>
S 5.13 L _A	<div style="border: 1px solid black; padding: 5px;"> ANALOG INPUT ALARM DISABLED </div>	<p>This message allows the user to enable or disable analog input alarms.</p>
<p><i>Messages S 5.14 to 5.16 will only appear if ENABLED is selected in message S 5.13.</i></p>		
S 5.14 L _A	<div style="border: 1px solid black; padding: 5px;"> ANALOG IN ALARM 12.00 UNITS </div>	<p>This line allows the user to specify at what level of input analog signal the 565 Relay will initiate an alarm. The level must be entered within the range of the scaled values, see messages S 5.7 and 5.8. The units displayed here will be those entered in message S 5.6.</p>
S 5.15 L _A	<div style="border: 1px solid black; padding: 5px;"> ANALOG IN ALARM DELAY 1 SEC </div>	<p>The delay on the alarm for the analog input is entered here, in the range of 1 to 255 seconds in steps of 1 second. This prevents nuisance alarms due to momentary (normal) high signals. Should the condition persist beyond the timed period the alarm will occur.</p>
S 5.16 L _A	<div style="border: 1px solid black; padding: 5px;"> ANALOG IN ALARM RELAY AUX1 </div>	<p>This message allows the user to select the relay which the alarm signal generated in message S 5.13, will activate.</p>

SETPOINTS MODE - ANALOG INPUT



Location	Message Line	Description
S 5.17 L _A	ANALOG INPUT END OF PAGE	The last line of page 5, setpoints. Press the PAGE key to view page 6.

www.ElectricalPartManuals.com

Location	Message Line	Description
S 6.1 L _A	SETPOINTS ANALOG OUTPUT	The setpoints page 6 header. This page allows the setpoints related to the analog output to be entered.
S 6.2 L _A	ANALOG OUTPUT PARAMETER	This message appears for two seconds to indicate that the analog output parameter can now be specified. The 565 Relay is capable of sending out any one of 8 actual values as analog quantities from its Analog Out terminal on the rear of the unit. This message is replaced by a message showing the current selection for the analog out parameter. The NEXT CHOICE key can then be used to select the desired analog out parameter. These parameters are the 3 phase currents, the 3 phase voltages, the ground current, and the feeder frequency.
S 6.3 L _A	PHASE A CURRENT	

If external analog select is stored, the analog output parameter will be chosen by an external device such as a programmable controller via the 565 rear. The device can request any output by presenting the correct code at the 4 analog select terminals (A,B,C,D) on the unit. The outputs are shown in the figure below with ON for logic 1 and OFF for logic 0. "ON" indicates a closure or jumper between the specified terminal and the switch return. For example an input of 1 is at terminals A, and 0 at B and C and D, the analog out parameter will be Phase B current.

INPUT AT TERMINAL				SELECTED OUTPUT
D	C	B	A	
OFF	OFF	OFF	OFF	Phase A current.
OFF	OFF	OFF	ON	Phase B current.
OFF	OFF	ON	OFF	Phase C current.
OFF	OFF	ON	ON	Ground current.
OFF	ON	OFF	OFF	Phase A-X voltage.
OFF	ON	OFF	ON	Phase B-X voltage.
OFF	ON	ON	OFF	Phase C-X voltage.
OFF	ON	ON	ON	Feeder frequency.

Location	Message Line	Description
S 6.4 L _A	ANALOG OUTPUT RANGE : 4-20 mA	The range of the analog output may be selected using this message. Use the NEXT CHOICE key to select either 4-20 mA or 0-1 mA depending on the input range of the device to which the analog output is being sent. Store the selected value. The magnitude of the analog output will then vary linearly with the magnitude of the selected analog output parameter within the selected range.

Analog Output Parameter	Minimum Output	Maximum Output
1) Currents	0	2 times pickup (Phase and Ground)
2) Phase Voltages	0	2 times nominal feeder voltage
3) Frequency	57 Hz	63 Hz (60 cycle feeder)
4) Frequency	47 Hz	53 Hz (50 cycle feeder)

Location	Message Line	Description
S 6.5 L _A	ANALOG OUTPUT END OF PAGE	The last line of page 6, setpoints. Press the PAGE key to view page 7.

SETPOINTS MODE - COMMUNICATION



Location	Message Line	Description
S 7.1	SETPOINTS COMMUNICATIONS	The setpoints page 7 header. This page contains setpoints which affect how the 565 Relay communicates with other devices.
S 7.2	RELAY ADDRESS 1	This message is used to assign each relay a different address or number to distinguish it from all other relays being used in a serial communication link. The range of values which may be entered is 1 to 254 in steps of 1.
S 7.3	BAUDRATE 2400 BAUD	This setpoint is used to select the data transfer rate for serial communications via the front Programming Port or the rear Communication Port. Use NEXT CHOICE key to select either 1200, 2400, 4800, or 9600 BAUD.
S 7.4	COMMUNICATIONS END OF PAGE	The last line of page 7, setpoints. Press the PAGE key to view page 7.

Location	Message Line	Description
S 8.1	<div style="border: 1px solid black; padding: 5px; text-align: center;"> SETPOINTS CALIBRATION MODE </div>	The setpoints page 8 header. This page is used to test the operation of the 565 switch inputs and output relays. As well, the LCD display contrast can be adjusted on this page.
S 8.2	<div style="border: 1px solid black; padding: 5px; text-align: center;"> EXERCISE RELAY TRIP </div>	<p>This message is used to test the operation of the output relay contacts. The following choices are available:</p> <p>1) Trip. 4) Aux. 3. 7) ALL 2) Aux. 1. 5) Aux. 4 (575 only) 3) Aux. 2. 6) Block Tap Changer (575 only)</p> <p>Select the required relay using the NEXT CHOICE key. Press the store key to simulate the presence of a condition that will activate the selected relay.</p>

Before testing, verify that it is safe to do so. **(These tests can only be done with the feeder breaker open.)** If the breaker is closed, the following flash message will be displayed:

	<div style="border: 1px solid black; padding: 5px; text-align: center;"> BREAKER MUST BE OPEN </div>	
S 8.3	<div style="border: 1px solid black; padding: 5px; text-align: center;"> PRESS STORE TO END TEST... </div>	This message appears while the activating condition is present. The relay will be tested in the mode of operation assigned to it. For example, a latched relay will be energized and will then remain latched. Press the STORE key to remove the simulated activating condition.
S 8.4	<div style="border: 1px solid black; padding: 5px; text-align: center;"> PRESS RESET TO RESET RELAY </div>	This message appears on the display for two seconds to remind the user that if a latched relay has been tested, then the reset key must now be pressed to return the relay to its inactive state.
S 8.5 L _A	<div style="border: 1px solid black; padding: 5px; text-align: center;"> SWITCH NUMBER 1 STATUS OPEN </div>	This message allows each of the external switches to have its status checked. Use the LINE DOWN key to display each of the switches. The status of each switch, either OPEN or CLOSED will appear in the message.
S 8.6 L _A	<div style="border: 1px solid black; padding: 5px; text-align: center;"> BREAKER OPEN STATUS YES </div>	This message allows the breaker open external contacts to have their status checked.
S 8.7 L _A	<div style="border: 1px solid black; padding: 5px; text-align: center;"> BREAKER CLOSED STATUS NO </div>	This message allows the breaker closed external contacts to have their status checked.
S 8.8 L _A	<div style="border: 1px solid black; padding: 5px; text-align: center;"> ANALOG SELECT A STATUS OFF </div>	This message allows each of the analog select switches to have its status checked. Use the LINE DOWN key to display each of the switches. The status of each switch, either ON or OFF, will appear in the messages.
S 8.9 L _A	<div style="border: 1px solid black; padding: 5px; text-align: center;"> ACCESS JUMPER STATUS ENABLED </div>	This message indicates the status of the access jumper. ENABLED indicates jumper installed. DISABLED indicates jumper not installed.
S 8.10 L _A	<div style="border: 1px solid black; padding: 5px; text-align: center;"> REMOTE/LOCAL 43 STATUS LOCAL </div>	
S 8.11 L _A	<div style="border: 1px solid black; padding: 5px; text-align: center;"> RECLOSE ENABLED STATUS YES </div>	This message indicates the status of the internal hardware relay which enables or disables the reclosing scheme.

SETPOINTS MODE - CALIBRATION



Location	Message Line	Description
S 8.12	RECLOSE DISABLED STATUS NO	This message indicates the status of the internal hardware relay which enables or disables the reclosing scheme.
S 8.13	LCD DISPLAY CONTRAST 5	This message allows the contrast of the display to be adjusted to suit the user. The range of adjustment is 0-10.
S 8.14	58E271B.000 MAR 28,1994	This is the 565 Relay Firmware revision identifier.
S 8.15	SERVICE USE ONLY CODE 0	This message is used by service personnel for calibration and service of the 565 Relay. It is not intended for use by other than MULTILIN personnel.
S 8.16	CALIBRATION MODE END OF PAGE	The last line of page 8, setpoints. Press the PAGE key to view page 9.

Location	Message Line	Description
S 9.1	SETPOINTS VOLTAGE	The setpoints page 9 header. The 565 Relay can provide protection against voltage related faults. In this page the voltage related setpoints are entered.

Table 6-1 Phase Configuration for Voltage Alarms and Trips

VT CONNECTION	UNDERVOLTAGE TRIP	UNDERVOLTAGE ALARM	OVERVOLTAGE TRIP	OVERVOLTAGE ALARM
WYE	ANY TWO PHASE	ANY SINGLE PHASE	ANY SINGLE PHASE	ANY SINGLE PHASE
OPEN DELTA	TWO MEASURED PHASES (Vab & Vbc)	ONE MEASURED PHASE (Vab OR Vbc)	ONE MEASURED PHASE (Vab OR Vbc)	ONE MEASURED PHASE (Vab OR Vbc)

S 9.2	VT CONNECTION WYE	<p>This message asks for the type of voltage transformer sensing which you intend to use. There are three possible systems, as shown in wiring Figure 2.6. The choices for the setpoint are:</p> <ol style="list-style-type: none"> 1. Wye. 2. Open Delta. 3. Delta/Wye 4. None <p>The Delta/Wye choice allows the 565/575 to measure secondary voltages wired as Wye and display them as phase to phase quantities on the primary side of a Delta/Wye connected transformer. Hence, selecting Delta/Wye does not multiply the result by $\sqrt{3}$. For example:</p> <p>In a 2.4 kV:120V PT system (i.e. 120V into the relay), WYE displays 2.4 kV A-N, DELTA/WYE displays 2.4 kV A-B, <u>NOT</u> $2.4 \text{ kV} \times \sqrt{3}$.</p> <p>If none is selected, voltage sensing will be disabled.</p> <p>Refer to your system specifications or one line diagram to determine which your system is. Use the NEXT CHOICE key to select the appropriate one and press the STORE Key to save the new value.</p>
-------	----------------------	---

Only message S 9.21 will appear if the VT connection is selected as NONE in message S 9.2.

S 9.3	VT NOMINAL SEC VOLTS 120 VOLTS	<p>The voltage transformer which you are using to sense voltage may operate at various secondary voltages depending on the sensing system used.</p> <p>The 565/575 has the ability to be programmed for the desired secondary rating, which should be the rated secondary voltage stamped on the transformer's nameplate. This will be the phase to neutral voltage for a Wye system, or a phase to phase voltage for an Open Delta system. The range is from 48 to 240 V in steps of 0.1 V.</p>
S 9.4	VT PRIMARY VOLTS 1.20 kV	<p>The primary voltage of the VT which monitors the feeder is entered here. This is the "nameplate" primary voltage. The voltage transformer primary rating range is from 0.10 to 69 kV in steps of 0.01 kV.</p>
S 9.5	ZERO VOLTS DETECT ENABLED	<p>When enabled, this setpoint allows undervoltage alarms and trips to occur with the 565/575 reading <u>all</u> phase voltages as zero. For the 565/575, zero is when the voltage is below 48% of the nominal rating. When disabled, <u>all</u> phases reading below 48% are considered a normal no voltage condition. Thus, no alarms or trips will be declared. As always, undervoltage trips</p>

SETPOINTS MODE - VOLTAGE



Location	Message Line	Description
		only occur when the breaker is detected as closed.
S 9.6	<div style="border: 1px solid black; padding: 5px;"> UNDERVOLT TRIP DISABLED </div>	<p>This message allows the undervoltage trip to be enabled or disabled. The Undervoltage Trip feature will activate when any two line-to-line voltages stay below the trip setpoint for the selected time delay. NOTE: When an undervoltage condition is present the reclosure scheme will not issue a close command to the breaker. When the undervoltage condition is no longer present, the breaker should be closed manually.</p>
<p>Messages S 9.7 to S 9.9 will only appear if ENABLED is selected in message S 9.6.</p>		
S 9.7	<div style="border: 1px solid black; padding: 5px;"> UNDERVOLT TRIP LEVEL 80 %VT </div>	<p>The undervoltage trip level is entered here as a percentage of the VT rating. Feeder undervoltage protection is necessary because a significant drop in feeder voltage indicates a system fault.</p> <p>The 565/575 Relay monitors the phase voltages while the breaker is closed and provides a trip signal if the level drops to the value which you enter here. The range of possible settings for the undervoltage setpoint is 50% to 100% of the VT rating in steps of 1%. Refer to Table 2.1 to determine how many phases must be below the trip level to cause a trip for the VT connection being used.</p>
S 9.8	<div style="border: 1px solid black; padding: 5px;"> UNDERVOLT TRIP DELAY 1.0 SEC </div>	<p>The delay on the undervoltage trip is entered here, in the range of 0.1 to 25.5 seconds in steps of 0.1 seconds. This prevents nuisance trips caused by momentary low voltages due to sudden switching of heavy loads on or off the feeder. Should the condition persist beyond the timed period the trip will occur.</p>
S 9.9	<div style="border: 1px solid black; padding: 5px;"> UNDERVOLT TRIP RELAY TRIP&AUX1 </div>	<p>This message allows the user to select the relay which the trip signal generated in message S 9.6 will activate.</p>
S 9.10	<div style="border: 1px solid black; padding: 5px;"> UNDERVOLT ALARM DISABLED </div>	<p>This message allows the undervoltage alarm to be enabled or disabled.</p>
L _A		
<p>Messages S 9.11 to 9.13 will only appear if ENABLED is selected in message S 9.10.</p>		
S 9.11	<div style="border: 1px solid black; padding: 5px;"> UNDERVOLT ALARM LEVEL 85 %VT </div>	<p>The undervoltage alarm level is entered here as a percentage of the VT rating. Feeder undervoltage alarms are necessary to warn of impending voltage related problems. The range of possible settings for the undervoltage alarm setpoint is 50% to 100% of the VT rating in steps of 1%. Refer to Table 2.1 to determine how many phases must be below the alarm level to cause an alarm for the VT connection being used.</p>
L _A		
S 9.12	<div style="border: 1px solid black; padding: 5px;"> UNDERVOLT ALARM DELAY 1.0 SEC </div>	<p>The delay on the undervoltage alarm is entered here, in the range of 0.1 to 25.5 seconds in steps of 0.1 seconds. See message S 9.8 for more information.</p>
L _A		
S 9.13	<div style="border: 1px solid black; padding: 5px;"> UNDERVOLT ALARM RELAY AUX2 </div>	<p>This message allows the user to select the relay which the alarm signal generated in message S 9.10 will activate.</p>
L _A		
S 9.14	<div style="border: 1px solid black; padding: 5px;"> OVERVOLT TRIP DISABLED </div>	<p>This message allows the overvoltage trip to be enabled or disabled. The overvoltage trip feature will activate when any phase voltage stays above the trip setpoint for the selected time delay. NOTE: When an overvoltage condition is present the reclosure scheme will not issue a close command to the breaker. When the overvoltage condition is no longer present, the breaker should be closed manually.</p>
L _A		

Location	Message Line	Description
----------	--------------	-------------

Messages S 9.15 to 9.17 will only appear if ENABLED is selected in message S 9.14.

S 9.15	<div style="border: 1px solid black; padding: 5px;"> OVERVOLT TRIP LEVEL 120 %VT </div>	The overvoltage trip level is entered here as a percentage of the VT rating. The range of possible settings for the overvoltage trip setpoint is 101% to 125% of the VT rating in steps of 1%. The breaker must be closed for overvoltage trips to be detected. Refer to Table 2.1 to determine how many phases must be above the trip level to cause a trip for the VT connection being used.
--------	---	--

S 9.16	<div style="border: 1px solid black; padding: 5px;"> OVERVOLT TRIP DELAY 1.0 SEC </div>	The delay on the overvoltage trip is entered here, in the range of 0.1 to 25.5 seconds in steps of 0.1 seconds. This delay prevents nuisance trips. Should the condition persist beyond the timed period the trip will occur.
--------	---	---

S 9.17	<div style="border: 1px solid black; padding: 5px;"> OVERVOLT TRIP RELAY TRIP </div>	This message allows the user to select the relay which the trip signal generated in message S 9.14, will activate.
--------	--	--

S 9.18	<div style="border: 1px solid black; padding: 5px;"> OVERVOLT ALARM DISABLED </div>	This message allows the overvoltage alarm to be enabled or disabled.
--------	--	--

Messages S 9.19 to 9.21 will only appear if ENABLED is selected in message S 9.18.

S 9.19	<div style="border: 1px solid black; padding: 5px;"> OVERVOLT ALARM LEVEL 115 %VT </div>	The overvoltage alarm level is entered here as a percentage of the VT rating. The 565 Relay monitors the phase voltages and provides an alarm if the level rises to the level which you enter here. The range of possible settings for the overvoltage alarm setpoint is 101% to 125% of the VT rating in steps of 1%. Refer to Table 2.1 to determine how many phases must be above the alarm level to cause an alarm for the VT connection being used.
--------	--	--

S 9.20	<div style="border: 1px solid black; padding: 5px;"> OVERVOLT ALARM DELAY 1.0 SEC </div>	The delay on the overvoltage alarm is entered here, in the range of 0.1 to 25.5 seconds in steps of 0.1 seconds. As for the undervoltage delay, this delay prevents nuisance trips due to momentary high signals. Should the overvoltage persist beyond the timed period the alarm will occur.
--------	--	--

S 9.21	<div style="border: 1px solid black; padding: 5px;"> OVERVOLT ALARM RELAY AUX1 </div>	This message allows the user to select the relay which the alarm signal generated in message S 9.18 will activate.
--------	---	--

S 9.22	<div style="border: 1px solid black; padding: 5px;"> VOLTAGE END OF PAGE </div>	The last line of page 9, setpoints. Use the PAGE key to view page 10.
--------	--	---

SETPOINTS MODE - DEMAND METERING



Location	Message Line	Description
S 10.1	<div style="border: 1px solid black; padding: 5px; text-align: center;"> SETPOINTS DEMAND METERING </div>	Setpoints page 10 header. In this page are the setpoints which set up the demand metering functions.
S 10.2	<div style="border: 1px solid black; padding: 5px; text-align: center;"> AMPS DEMAND ENABLED </div>	<p>This message allows the user to enable or disable the Amps Demand feature. If this feature is disabled, the Peak Amps Demand value will be the last peak value before the function was disabled. The peak amps demand of each phase is obtained by a "sliding window" averaging scheme by which the current (averaged RMS values) is monitored at 1 minute intervals over the chosen demand time window and stored in memory. The demand time window is user selectable over the range 5–120 min. in 1 min. steps. The peak demand amps is updated only when the demand window current average exceeds the previous stored peak value.</p> <p>The 565/575 also allows the user to select and store an alarm level for peak demand which can be assigned to an output relay.</p>

Messages S 10.3 to S 10.6 will only appear if ENABLED is selected in message S 10.2.

S 10.3	<div style="border: 1px solid black; padding: 5px;"> AMPS DEMAND TIME PERIOD 5 MIN </div>	<p>This message allows the user to specify Amps Demand time period. The range of values is 5 to 120 in steps of 1 minute. This value is essentially the number of RMS current values used to determine the current demand. NOTE: If this setpoint or the Phase CT Primary Rating are changed, the Amps Demand function will be reset and the Peak Demand values shown in the Meter Data will be cleared.</p>
--------	--	--

S 10.4 L _A	<div style="border: 1px solid black; padding: 5px;"> AMPS DEMAND ALARM DISABLED </div>	This message allows users to enable or disable the alarm function.
--------------------------	---	--

Messages S 10.5 and S 10.6 will only appear if ENABLED is selected in message S 10.4.

S 10.5 L _A	<div style="border: 1px solid black; padding: 5px;"> AMP DEMAND ALARM LEVEL 100 A </div>	The Amps Demand alarm level is specified here. The range of values allowed is 10 to 5000 in steps of 5 amps.
--------------------------	---	--

S 10.6 L _A	<div style="border: 1px solid black; padding: 5px;"> AMP DEMAND ALARM RELAY AUX1 </div>	This message allows users to assign Aux.1 and/or Aux.2 relays to the alarm. When an alarm occurs, the selected relay will be activated.
--------------------------	--	---

The following messages will only be displayed if the Metering Transducer Module (MTM) has been enabled in page 4 of setpoints. Note that these features only function when an Option Card is installed.

S 10.7	<div style="border: 1px solid black; padding: 5px; text-align: center;"> KW DEMAND ENABLED </div>	<p>This message allows the user to enable or disable the kW demand feature. If this feature is disabled the peak kW demand value will be the last peak value before the feature was disabled.</p>
--------	---	---

Messages S 10.8 to S 10.11 will only appear if ENABLED is selected in message S 10.7.

S 10.8	<div style="border: 1px solid black; padding: 5px;"> KW DEMAND TIME PERIOD 5 MIN </div>	<p>This message allows the user to specify the time period over which the kW demand is calculated. The range of values is 5 to 120 minutes in steps of 1 minute. NOTE: If this setpoint or the Phase CT Primary rating are changed the kW demand function will be reset and the peak kW demand value shown in the Metering Data will be cleared.</p>
--------	--	--

S 10.9	<div style="border: 1px solid black; padding: 5px; text-align: center;"> KW DEMAND ALARM DISABLED </div>	This message allows the user to enable or disable the alarm function.
--------	--	---

Location	Message Line	Description
<i>Messages S 10.10 and S 10.11 will only appear if the Demand KW Alarm feature is enabled in message S 10.9.</i>		
S 10.10	<div style="border: 1px solid black; padding: 5px;"> KW DEMAND ALARM LEVEL 1000 kW </div>	The kW Demand alarm level is specified here. The range is 100 to 65000 kW in steps of 100 kW.
S 10.11	<div style="border: 1px solid black; padding: 5px;"> KW DEMAND ALARM RELAY AUX1 </div>	This message allows the user to select the relay which will be activated when an alarm occurs.
S 10.12	<div style="border: 1px solid black; padding: 5px;"> KVAR DEMAND ENABLED </div>	This message allows the user to enable or disable the kVAR demand feature. If this feature is disabled the Peak kVAR Demand value will be the last peak value before the feature was disabled.
<i>Messages S 10.13 to S 10.16 will only appear if ENABLED is selected in message S 10.12.</i>		
S 10.13	<div style="border: 1px solid black; padding: 5px;"> KVAR DEMAND TIME PERIOD 5 MIN </div>	This message allows the user to specify the time period over which the kVAR demand is calculated. The range of values is 5 to 120 minutes in steps of 1 minute. NOTE: If this setpoint or the Phase CT Primary rating are changed the kVAR demand function will be reset and the peak kVAR Demand value shown in the Metering Data will be cleared.
S 10.14	<div style="border: 1px solid black; padding: 5px;"> KVAR DEMAND ALARM DISABLED </div>	This message allows the user to enable or disable the alarm function.
<i>Messages S 10.15 and S 10.16 will only appear if the Demand kVAR Alarm feature is enabled in message S 10.14.</i>		
S 10.15	<div style="border: 1px solid black; padding: 5px;"> KVAR DEMAND AL'M LEVEL 1000 kVAR </div>	The kVAR Demand alarm level is specified here. The range is 100 to 65000 kW in steps of 100 kW.
S 10.16	<div style="border: 1px solid black; padding: 5px;"> KVAR DEMAND AL'M RELAY AUX1 </div>	The user is allowed to select the relay which will be activated when an alarm occurs.
S 10.17	<div style="border: 1px solid black; padding: 5px;"> DEMAND METERING END OF PAGE </div>	End of page 10, setpoints. Press the PAGE key to view page 11.

SETPOINTS MODE - MTM METERING



Location	Message Line	Description
S 11.1	<div style="border: 1px solid black; padding: 5px;"> SETPOINTS MTM METERING </div>	The setpoints page 11 header. In this page the MTM related setpoints are entered.
	<div style="border: 1px solid black; padding: 5px;"> OPTION NOT AVAILABLE </div>	This message appears if ENABLED is selected in S 11.1 but the 565 does not have the option card installed.

The following messages will only be displayed if the Metering Transducer Module (MTM) has been enabled in page 4 of setpoints.

S 11.2	<div style="border: 1px solid black; padding: 5px;"> MTM COMM. ALARM DISABLED </div>	<p>This message allows the user to enable or disable the MTM alarm feature. When enabled, an MTM communications breakdown will activate an alarm.</p> <p>A typical communication breakdown is confusion of whether the source of the MTM default power is LINE or PT. The default is line, not PT. If PT is required this must be selected by using the switches on the MTM.</p> <p>In order for a 565/575 Relay to communicate with an MTM Plus device prior to rev. E, the MTM Plus baud rate must be set to 1200.</p>
--------	--	--

Message S 11.3 will only appear if ENABLED is selected in message S 11.2.

S 11.3	<div style="border: 1px solid black; padding: 5px;"> MTM COMM. ALARM RELAY AUX2 </div>	This message lets the user assign a relay to be activated by the MTM communications alarm.
S 11.4	<div style="border: 1px solid black; padding: 5px;"> MTM CT SELECT COMMON </div>	When the MTM is connected, the same CTs can be used (COMMON) or another (SEPARATE) set of CTs are used.

Message S 11.5 will only appear if SEPARATE is selected in message S 11.4.

S 11.5	<div style="border: 1px solid black; padding: 5px;"> MTM CT RATING PRIMARY 100 A </div>	Enter the CT ratio for the MTM if you have chosen a SEPARATE set of CTs as selected above.
S 11.6	<div style="border: 1px solid black; padding: 5px;"> POWER FACTOR ALARM DISABLED </div>	This message allows the user to enable or disable the alarm feature for the Power Factor.

Messages S 11.7 to 11.10 will appear only if the Power Factor Alarm feature has been enabled in message S 11.6.

S 11.7	<div style="border: 1px solid black; padding: 5px;"> P/F LEADING ALARM LEVEL 0.75 </div>	The leading alarm level is chosen here. The range is 0 to 1 in steps of 0.05.
S 11.8	<div style="border: 1px solid black; padding: 5px;"> P/F LAGGING ALARM LEVEL 0.75 </div>	The lagging alarm level is chosen here. The range is 1 to 0 in steps of 0.05.
S 11.9	<div style="border: 1px solid black; padding: 5px;"> P/F ALARM DELAY 5.0 SEC </div>	The delay time before an alarm is given can be selected here. Range is 1 - 127 seconds in steps of 0.5 seconds.
S 11.10	<div style="border: 1px solid black; padding: 5px;"> P/F ALARM RELAY AUX1 </div>	This message indicates which relay will be activated when the alarm level is exceeded. The choices are: AUX1, AUX2, or AUX1&AUX2. For 575, they are: NONE, AUX1, AUX2, or AUX1&2.

Location	Message Line	Description
S 11.11	POWER FACTOR TRIP DISABLED	This message allows the user to enable or disable the trip feature for the Power Factor.
<i>Messages S 11.12 to S 11.15 appear only if the Power Factor Trip feature has been enabled in message S 11.11.</i>		
S 11.12	P/F LEADING TRIP LEVEL 0.70	The leading trip level is chosen here. The range is 0 to 1 in steps of 0.05.
S 11.13	P/F LAGGING TRIP LEVEL 0.70	The lagging trip level is chosen here. The range is 1 to 0 in steps of 0.05.
S 11.14	P/F TRIP DELAY 1.0 SEC	The delay time before a trip is given can be selected here. Range is 1 - 127 sec. in steps of 0.5 sec.
S 11.15	P/F TRIP RELAY AUX1	This message indicates which relay will be activated when the trip level is exceeded.
S 11.16	FREQUENCY ALARM DISABLED	This message allows the user to enable or disable the frequency alarm feature.
<i>Messages S 11.17 to S 11.20 appear only if the Frequency Alarm feature has been enabled in message S 11.16.</i>		
S 11.17	UNDER FREQ ALARM LEVEL 58.0 Hz	The under frequency alarm level is chosen here. The range is 40 - 60 Hz in steps of 0.1.
S 11.18	OVER FREQ ALARM LEVEL 62.0 Hz	The over frequency alarm level is chosen here. The range is 50 - 72 Hz in steps of 0.1.
S 11.19	FREQUENCY ALARM DELAY 5.0 SEC	The delay time before an alarm is given can be selected here. Range is 1 - 127 sec. in steps of 0.5 sec.
S 11.20	FREQUENCY ALARM RELAY AUX1	This message indicates which relay will be activated when the alarm level is exceeded.
S 11.21	FREQUENCY TRIP DISABLED	This message allows the user to enable or disable the frequency trip feature.
<i>Messages S 11.22 to S 11.25 appear only if the Frequency Trip feature has been enabled in message S 11.21.</i>		
S 11.22	UNDER FREQ. TRIP LEVEL 56.0 Hz	The under frequency trip level is chosen here. The range is 40 - 60 Hz in steps of 0.1.
S 11.23	OVER FREQ. TRIP LEVEL 64.0 Hz	The over frequency trip level is chosen here. The range is 50 - 72 Hz in steps of 0.1.

SETPOINTS MODE - MTM METERING



Location	Message Line	Description
S 11.24	FREQUENCY TRIP DELAY 1.0 SEC	The delay time before a trip is given can be selected here. Range is 1 - 127 sec. in steps of 0.5 sec.
S 11.25	FREQUENCY TRIP RELAY AUX1	This message indicates which relay will be activated when the trip level is exceeded.
S 11.26	MTM SCALING FACTOR 655	This setpoint ranges from 1 to 655 and is used to set the full scale value for the MTM analog outputs (KWatts and KVars). Full scale would then be as follows: 100KW x scaling factor 30KVar x scaling factor
S 11.27	VOLTAGE REVERSAL TRIP ENABLED	The 565/575 Relay incorporates the Voltage Reversal Trip feature. In order to operate the feature successfully, the 565/575 must be communicating with the MTM or MTM Plus, since the MTM/MTM Plus performs the calculations to determine phase reversals. The 565/575 Relay provides only Trip Relay Output and Programmable Trip Delay. The Phase Reversal Trip of the 565/575 is independent of the Phase Reversal setpoint in the MTM/MTM Plus. This means that whether the setpoint is ENABLED or DISABLED in the MTM/MTM Plus, the 565/575 still polls for and receives report on phase reversals.
S 11.28	VOLTAGE REVERSAL DELAY 1.0 SEC	The Voltage Phase Reversal Delay is entered here in the range of 1 to 127 sec. in steps of 0.5 sec.
S 11.29	VOLTAGE REVERSAL RELAY TRIP	This setpoint allows the selection of the relay that will be activated when a voltage reversal is detected.
S 11.30	MTM METERING END OF PAGE	This is the last line of Setpoints, page 11. This is the last page of setpoints.

NOTE: Prior to describing the setpoints pertaining to Autoreclosure, the following is a discussion of the Multilin 575 reclosure scheme and input terminals.

Auto-Reclosure Application for 575

1. Introduction

Utility statistics indicate that a large percentage of feeder faults are of a transient nature, for example, phase conductors blown together by the wind, branches falling across phase conductors, or animals shorting to a grounded structure. In most cases, after the fault arc is initiated, the shorting media is burned off and the feeder is cleared.

A variety of overcurrent protective devices are used on feeders, starting with a feeder circuit breaker at the distribution station and fused sectionalizers as well as various reclosers downstream. All these devices are in series with each other. Should the transient fault current magnitude be larger than the melting current of the fuses, sections of the feeder will be incapacitated until line crews are sent out to locate the open device, replace the fuses and place the feeder back in service. Many customers will then be inconvenienced unnecessarily. It is for this reason that reclosure is necessary.

Ideally, when a fault is sensed on a feeder, the relaying scheme at the distribution station will cause the appropriate circuit breaker to trip, thus clearing the fault regardless of its location along the feeder. At the same time a reclosure scheme will be initiated causing only a very short disturbance to the system if the fault is transient.

Essentially, a reclosure scheme is a pre-programmed sequence of commands to reclose a circuit breaker a pre-determined number of times (or shots) after pre-determined time delays (dead times), after the feeder circuit breaker is tripped initially by the feeder protection scheme. When the maximum number of reclosures has been reached the breaker will be locked out since the fault has not been cleared and thus is likely not of a transient nature.

Sequentially, the events leading to a lockout situation in a four shot reclosure scheme are as follows:

1. First trip.
2. Wait until dead time #1 has expired.
3. Reclose breaker.
4. Second trip.
5. Wait until dead time #2 has expired.
6. Reclose breaker.
7. Third trip.
8. Wait until dead time #3 has expired.
9. Reclose breaker.
10. Fourth trip.
11. Wait until dead time #4 has expired.
12. Reclose breaker.
13. Fifth trip.
14. Breaker is locked out.

After this sequence of events the reclosure & relay must be manually reset at the relay or through remote supervisory.

Certain trip features may also be blocked (disabled) after the

nth reclosure attempt. For example, Phase Lowset Instantaneous trips may be blocked after the nth reclosure to allow whatever is causing the fault to burn off at a higher fault current level than that allowed by the Phase Lowset setting. Phase Lowset trips would then be re-enabled after the scheme is reset.

The scheme can be "reset" to its initial condition if, after any of the reclosures, a reclaim or reset timer expires without a new trip being initiated.

2. Multilin 575 Reclosure Scheme

The Multilin 575 reclosure scheme is based on a scheme developed by some major North American utilities. The scheme follows the overview shown in Figure 3.5 with some additional features unique to the Multilin 575, but allows some flexibility through user setpoint programming. Note that Figure 3.5 is a conceptual drawing to develop the 575 software and is not intended to be implemented in hardware.

Two modes of 575 operation are provided: LOCAL and REMOTE. LOCAL mode indicates that control is provided by the 575 keypad. REMOTE mode indicates that control is provided by dry contacts external to the 575.

Reclosure Enable/Disable can be executed in either LOCAL or REMOTE mode. A LOCAL/REMOTE switch (device #43) must be wired to the 575 to select the mode.

A hardware latching relay is used in the 575 to enable or disable the reclosure scheme. This is implemented in hardware to provide another level of security. If the reclosure scheme is disabled the breaker cannot be reclosed by incorrect operation of the reclosure algorithm.

The reclosure routine will not perform any function until the reclosure scheme is enabled (either locally or remotely) and one of the following conditions occurs:

1. Low set instantaneous trip (any two phases or ground).
2. High set instantaneous trip (any phase or ground).
3. Timed overcurrent trip (phase or ground).
4. External Initiate of Reclosing.

To improve co-ordination with OCR line reclosures the 575 can be programmed to change the time overcurrent curve shapes during reclosure. The curve shapes are custom, extremely inverse, very inverse, normal inverse and moderately inverse.

As soon as the scheme is initiated the BLOCKTAP CHANGER output relay activates to block operation of a transformer tap changer. This relay resets when lockout condition is reached or the reset time causes the scheme to reset. Thus, this output relay is also an indication of "auto-reclosure in progress".

The PHASE INST HISET and/or GROUND INST HISET trip feature can be blocked (disabled) after any reclosure if

SETPOINTS MODE - AUTORECLOSURE



selected. The PHASE INST LOSET and/or GROUND INST LOSET trip feature can also be blocked after any reclosure as selected.

The scheme will be reset to its initial condition if, after any of the reclosures, the breaker closes and the current in all phases is less than the PHASE O/C PICKUP setpoint for a time greater than the reclosure SCHEME RESET time delay. This is an improvement over the traditional "reclaim" time since current sensing is used to ensure that the phase current is below the pickup level. The scheme will also be reset if the RESET key is pressed after a lockout condition has been reached.

3. 575 Output Relays

The following 575 output relays are used by the reclosure scheme:

NAME	FUNCTION	TERMINALS	CONTACT
TRIP	Trips C.B.	41 and 57 25 and 57	N/O N/C
CLOSE	Closes C.B.	42 and 58	N/O
AUX. 1	Operates with TRIP relay or is programmable to alarm function.	43 and 59 46 and 59	N/O N/C
AUX. 2	Programmable alarm function.	44 and 60 47 and 60	N/O N/C
AUX. 3	Failsafe operation on loss of control volts, and trip coil supervision.	45 and 61 48 and 61	N/C N/O
AUX. 4	Operates on occurrence of Breaker Discrepancy Alarm only.	30 and 31 32 and 31	N/O N/C
BLOCK TAP CHANGER			
	Operates to block operation of external transformer tap changer or can be used as reclosure in progress indication.	16 and 15 29 and 15	N/O N/C

4. 575 Input Terminals

The following inputs are required by the 575:

TERMINALS FUNCTION

- 9 and 10 Breaker auxiliary contacts (52b) must be wired here. These contacts are closed when the breaker is open.
- 11 and 10 Breaker auxiliary contacts (52a) must be wired here. These contacts are open when the breaker is open.
- 39 and 40 A LOCAL/REMOTE selector switch (43) should be wired here. When these contacts are open LOCAL mode is selected. When these contacts are closed REMOTE mode is selected.
- 26 and 27 Remote Trip contacts can be wired here. A contact closure here will cause the TRIP output relay to activate for as long as the input remains shorted.
- 28 and 27 Remote Close contacts can be wired here. A

contact closure here will cause the CLOSE output relay to activate for as long as the input remains shorted.

12 and 13 Remote Reclose Enable contacts can be wired here. When REMOTE mode is selected a contact closure here will cause the reclosure scheme to be enabled. These contacts drive a hardware latching relay in the 575 and can therefore be momentary.

14 and 13 Remote Reclose Disable contacts can be wired here. When remote mode is selected a contact closure here will cause the reclosure scheme to be disabled. These contacts drive a hardware latching relay in the 575 and can therefore be momentary.

Analog Input Trip and External Switch Trip

When either of these trips occur, the reclosure scheme will immediately go to the lockout condition. The lockout is software driven and not shown in hardware form on the Autoreclose logic schematic.

Location	Message Line	Description
S 12.1	<div style="border: 1px solid black; padding: 5px; text-align: center;"> SETPOINTS AUTO RECLOSURE </div>	The setpoints page 12 header. All the setpoints required for Auto Reclosure are entered in this page.
S 12.2	<div style="border: 1px solid black; padding: 5px; text-align: center;"> AUTO RECLOSURE DISABLED </div>	<p>This setpoint determines whether the reclosure scheme is enabled or disabled when LOCAL mode is selected. When REMOTE mode is selected this setpoint cannot be changed and the flash message</p> <div style="border: 1px solid black; padding: 5px; text-align: center; margin: 10px 0;"> ILLEGAL STORE IN REMOTE MODE </div> <p>will be displayed.</p> <p>The setpoints in messages S12.3 to S12.9 can only be stored while autoreclosure is disabled. If an attempt is made to store a setpoint while reclosure is enabled, the following message will flash:</p> <div style="border: 1px solid black; padding: 5px; text-align: center; margin: 10px 0;"> NO STORE WHILE RECLOSE ENABLE </div> <p>Range: DISABLED/ENABLED.</p>
S 12.3	<div style="border: 1px solid black; padding: 5px;"> NO. OF RECLOSE SHOTS 4 </div>	<p>This setpoint determines the number of reclose shots to implement. Range: 0-4.</p>
S 12.4	<div style="border: 1px solid black; padding: 5px;"> SHOT 1 DEAD TIME 2.0 SEC </div>	<p>This setpoint determines the dead time after the first trip. The first reclosure will be initiated after this time has elapsed. Range: 0.3-300 sec. This is part of 79R14 in the Autoreclosure Logic schematic.</p>
S 12.5	<div style="border: 1px solid black; padding: 5px;"> SHOT 2 DEAD TIME 4.0 SEC </div>	<p>Same as above for the second trip. Range: 0.3-300 sec. This is part of 79R14 in the Autoreclosure Logic schematic.</p>
S 12.6	<div style="border: 1px solid black; padding: 5px;"> SHOT 3 DEAD TIME 6.0 SEC </div>	<p>Same as above for the third trip. Range: 0.3-300 sec. This is part of 79R14 in the Autoreclosure Logic schematic.</p>
S 12.7	<div style="border: 1px solid black; padding: 5px;"> SHOT 4 DEAD TIME 8.0 SEC </div>	<p>Same as above for the fourth trip. Range: 0.3-300 sec. This is part of 79R14 in the Autoreclosure Logic schematic.</p>
S 12.8	<div style="border: 1px solid black; padding: 5px;"> SCHEME RESET TIME 5 SEC </div>	<p>The time required for the reclosure TIME scheme to reset itself. This timer will not operate unless the phase current in all phases is below the pickup level. Range: 1-255, increments of 1. This is 79TR18, 79TR20, 79TR22, and 79TR24 in the Autoreclosure Logic schematic.</p>
S 12.9	<div style="border: 1px solid black; padding: 5px;"> RECLOSURE ENABLE RELAY AUX2 </div>	<p>This setpoint determines which relay will activate when reclosure is enabled.</p>

SETPOINTS MODE - AUTORECLOSURE



Location	Message Line	Description
S 12.10	AUTO RECLOSURE END OF PAGE	Last line of Setpoints, page 12, autoreclosure. Use the PAGE key to view page 13.

www.ElectricalPartManuals.com

Location	Message Line	Description
S 13.1	<pre> SETPOINTS PHASE CURVES </pre>	The setpoints page 13 header. Setpoints required to program an alternate phase curve are entered here.
S 13.2	<pre> PHASE CURVE CHANGE DISABLED </pre>	This will enable the changing of the phase curve when enabled.
<i>Only message S 13.8 will appear if DISABLED is selected in message S 13.2.</i>		
S 13.3	<pre> SWITCH TO CURVE2 AFTER RECL. # 1 </pre>	Enter which reclosure you wish to close onto using the alternative phase curve. Alternative curves will remain until lockout occurs.
S 13.4	<pre> PH. O/C CURVE 2 SHAPE EXTREM INV </pre>	Enter the curve shape for the alternative phase curve.
<i>Message S 13.5 will not appear if CUSTOM2 was selected in message S 13.4.</i>		
S 13.5	<pre> PHASE O/C TIME DIAL 2 1 </pre>	Enter the time dial for the alternative phase curve.
<i>Messages S13.6 and S13.7 will only appear if CUSTOM2 was selected in message S13.4.</i>		
S 13.6	<pre> TRIP TIME2 (SEC) 1.03 xP/U= 1.0 </pre>	The trip time for the first breakpoint of the programmable alternative phase curve is entered here. The breakpoints are multiples of the pickup current.
L _A		
The remainder of the messages in this section are identical to those found in the PHASE CURRENT page of setpoints.		
S 13.7	<pre> TRIP TIME2 (SEC) 20.0 xP/U= 1.0 </pre>	The last trip time is entered here.
L _A		
S 13.8	<pre> PHASE CURVES END OF PAGE </pre>	Last line of Setpoints, page 13. Use the PAGE key to view page 14.

SETPOINTS MODE - GROUND CURVES



Location	Message Line	Description
S 14.1	<div style="border: 1px solid black; padding: 5px; text-align: center;"> SETPOINTS GROUND CURVES </div>	The setpoints page 14 header. Setpoints required to program an alternate ground curve are entered here.
S 14.2	<div style="border: 1px solid black; padding: 5px; text-align: center;"> GROUND CURVE CHANGE DISABLED </div>	This will enable the changing of the ground curve.
<i>Only message S 14.8 will appear if DISABLED is selected in message S 14.2.</i>		
S 14.3	<div style="border: 1px solid black; padding: 5px; text-align: center;"> SWITCH TO CURVE2 AFTER RECL. # 1 </div>	Enter which reclosure you wish to close onto using the alternative ground curve. Alternative curves will remain until lockout occurs.
S 14.4	<div style="border: 1px solid black; padding: 5px; text-align: center;"> GND O/C CURVE 2 SHAPE EXTREM INV </div>	Enter the curve shape for the alternative ground curve.
<i>Message S 14.5 will not appear if CUSTOM2 was selected in message S 14.4.</i>		
S 14.5	<div style="border: 1px solid black; padding: 5px; text-align: center;"> GROUND O/C TIME DIAL 2 1 </div>	Enter the time dial for the alternative ground curve.
<i>Messages S14.6 and S14.7 will only appear if CUSTOM2 was selected in message S14.4.</i>		
S 14.6 L _A	<div style="border: 1px solid black; padding: 5px; text-align: center;"> TRIP TIME2 (SEC) 1.03 xP/U= 1.0 </div>	The trip time for the first breakpoint of the programmable alternative ground curve is entered here. The breakpoints are multiples of the pickup current.
The remainder of the messages in this section are identical to those found in the GROUND CURRENT page of setpoints.		
S 14.7 L _A	<div style="border: 1px solid black; padding: 5px; text-align: center;"> TRIP TIME2 (SEC) 20.0 xP/U= 1.0 </div>	The last trip time is entered here.
S 14.8	<div style="border: 1px solid black; padding: 5px; text-align: center;"> GROUND CURVES END OF PAGE </div>	Last line of Setpoints, page 14. This is the last page of Setpoints.

Event Recording Information

Event recording is a feature of the 565 feeder relays. Data relating to one or more “events” is saved in memory and can be viewed by the operator through the front panel display or the rear RS232 printer port.

In order to use the Event Recording feature, the function must be enabled. In Setpoint mode, the lines of the Configuration page allow users to enable the Event Recording and Event Printing features.

(1.0) “Event” Definition

An “event” is defined as:

- a) occurrence of any set trip conditions,
- b) occurrence or disappearance of any set alarm condition, or
- c) occurrence of other extraordinary event (eg. install/removal of access jumper, enable/disable curve adjustment ...etc).

(1.1) Trip Event

Currently available trip events:

- a) any of the 4 timed overcurrent trips,
- b) any of the 4 instantaneous overcurrent trips,
- c) overvoltage or undervoltage trip,
- d) analog input trip,
- e) any of 4 external trips,
- f) power factor, and frequency trip (with Option Card).

(1.2) Alarm Event

Currently available alarm events:

- a) any of the 2 overcurrent alarms,
- b) overvoltage alarm,
- c) undervoltage alarm,
- d) analog input alarm,
- e) accumulated KA2 alarm,
- f) definite time alarms (or switch alarms),
- g) amps demand metering
- h) kW, and kVAR demand alarms (with Option Card),
- i) power factor and frequency alarms (with Option Card),
- j) breaker discrepancy and trip coil supervision alarms (with Option Card),
- k) MTM communications alarm (with Option Card).

(1.3) “Others” Event

Currently available “others” events:

- a) installation/removal of the access jumper,

- b) enable/disable of block instantaneous trip,
- c) enable/disable of block non-instantaneous trip,
- d) enable/disable of overcurrent curve adjustment,
- e) illegal access to setpoint,
- f) disappearance of alarm conditions,
- g) system manual reset,
- h) local/remote mode switch.

(2.0) Event Storage

All events will be stored in a memory buffer of the 565 unit, and up to 40 events will be accumulated. The buffer is operated in First-In-First-Out (FIFO) mode. If the buffer is full with 40 stored events, then as each new event occurs the oldest will be lost.

(2.1) Event Format

Each event is characterized by cause, time and date, and the magnitude of several measured feeder parameters, which are pertinent to the event, at the time of occurrence. The parameters which will be saved are:

- a) the cause of the event;
- b) the time and date of the event;
- c) each of the 4 RMS currents if it was a trip or alarm event, with the exception of Analog Input Trip, Analog Input Alarm and Accumulated KA2 Alarm events; and
- d) each of the 3 RMS phase (or line) voltages if it was a trip or an alarm event, with the exception of Analog Input Trip, Analog Input Alarm and Accumulated KA2 Alarm.

(3.0) Event Display Format

To view all the recorded events, users must enter the Actual Value mode, and select the “Event” page.

FEATURE INFORMATION



Cause of Event	Displayed Message
1) Phase A Timed O/C Trip	PH-A TIME O/C T
2) Phase B Timed O/C Trip	PH-B TIME O/C T
3) Phase C Timed O/C Trip	PH-C TIME O/C T
4) Ground Timed O/C Trip	GND TIMED O/C T
5) Phase A Inst Trip	PH-A INST O/C T
6) Phase B Inst Trip	PH-B INST O/C T
7) Phase C Inst Trip	PH-C INST O/C T
8) Ground Inst Trip	GND INST O/C T
9) Overvoltage Trip	OVERVOLTAGE T
10) Undervoltage Trip	UNDERVOLTAGE T
11) Analog Input Trip	ANALOG INPUT T
12) External Trip #1	EXT. TRIP #1 T
13) External Trip #2	EXT. TRIP #2 T
14) External Trip #3	EXT. TRIP #3 T
15) External Trip #4	EXT. TRIP #4 T
16) Power Factor Trip	P/F TRIP T
17) Frequency Trip	FREQ. TRIP T
18) Phase O/C Alarm	PH O/C ALARM A
19) Ground O/C Alarm	GND O/C ALARM A
20) Overvoltage Alarm	OVERVOLTAGE A
21) Undervoltage Alarm	UNDERVOLTAGE A
22) Analog Input Alarm	ANALOG INPUT A
23) Accumulated KA2 Alarm	ACCUM KA A
24) Definite Time Alarm 1	SWITCH ALARM1 A
25) Definite Time Alarm 2	SWITCH ALARM2 A
26) Amps Demand Alarm	AMPS DEMAND A
27) KW Demand Alarm	KW DEMAND A
28) KVAR Demand Alarm	KVAR DEMAND A
29) Power Factor Alarm	P/F ALARM A
30) Frequency Alarm	FREQ. ALARM A
31) Breaker Discepancy Alarm	BRK DISCRPNCY A
32) Trip Coil Alarm	TRIP COIL A
33) MTM Communications Alarm	MTM COMM ALM A
34) Phase O/C Alarm Reset	PH OC ALM RST O
35) Ground O/C Alarm Reset	GD OC ALM RST O
36) Overvoltage Alarm Reset	OV ALARM RST O
37) Undervoltage Alarm Reset	UV ALARM RST O
38) Analog Input Alarm Reset	AI ALARM RST O
39) Definite Time Alarm1 Reset	SW ALM1 RST O
40) Definite Time Alarm2 Reset	SW ALM2 RST O
41) Breaker Discrepancy Alarm Reset	BRK ALM RST O
42) Access Jumper Installed	AC JUMPER INS O
43) Access Jumper Removed	AC JUMPER REM O
44) Block Inst Trip Enabled	INST-BLOCK EN O
45) Block Inst Trip Disabled	INST-BLOCK DI O
46) Block Timed O/C Trips Enabled	TIMED-BLK ENB O
47) Block Timed O/C Trips Disabled	TIMED-BLK DIS O
48) Curve Adjust Enabled	CURVE ADJ. EN O
49) Curve Adjust Disabled	CURVE ADJ. DI O
50) Illegal Setpoint Access	ILL-ACCESS O
51) System Manual Reset	MANUAL RESET O
52) Control Switch to Remote	SWITCH REMOTE O
53) Control Switch to Local	SWITCH LOCAL O

(4.0) Event Print Format

Since there is a large variety of printers and it is impossible to interface with all of them, the 565 feeder relays are standardized to interface with EPSON FX-80 printers with serial input or other compatible printer. See section 2 of this manual for additional details.

The format of the event printout is specified as follows:

a) page size of 8.5"x11".

b) a header line is printed at the top of each page, on which the column fields are specified; they are:

- event reference number
- cause of event
- date and time
- any applicable measured parameters at the time of event (ie. 4 currents and 3 voltages)

c) each event takes two lines (because both cause of event and time/date fields require two lines).

For event printing, the header line is printed at the top of each page.

The following is an example of event printout:

No.	Cause of Event	Time/Date	Ia (A)	Ib (A)	Ic (A)	Ig (A)	Vax (KV)	Vbx (KV)	Vcx (KV)
01	Phase A Timed O/C Trip	16:42:56 03/15/92	1800	400	400	0	2.3	4.6	4.6
02	System Manual Reset	16:06:35 03/15/92							
03	Undervolt Alarm Reset	09:57:43 03/15/92	400	400	400	0	4.6	4.6	4.6
04	Undervoltage Alarm	09:53:09 03/15/92	400	400	400	0	4.2	4.6	4.6
05	Analog Input Alarm Reset	09:49:32 03/15/92							
06	Analog Input Alarm	21:02:16 03/14/92							

www.ElectricalPartManuals.com

FEATURE INFORMATION



The following lists all "Cause of Event" printout messages:

Cause of Event	Printout Message
1) Phase A Timed Overcurrent Trip	Phase A Timed O/C Trip
2) Phase B Timed Overcurrent Trip	Phase B Timed O/C Trip
3) Phase C Timed Overcurrent Trip	Phase C Timed O/C Trip
4) Ground Timed Overcurrent Trip	Ground Timed O/C Trip
5) Phase A Instantaneous Trip	Phase A Inst. O/C Trip
6) Phase B Instantaneous Trip	Phase B Inst. O/C Trip
7) Phase C Instantaneous Trip	Phase C Inst. O/C Trip
8) Ground Instantaneous Overcurrent Trip	Ground Inst. O/C Trip
9) Overvoltage Trip	Overvoltage Trip
10) Undervoltage Trip	Undervoltage Trip
11) Analog Input Trip	Analog Input Trip
12) External Trip #1	External Trip #1
13) External Trip #2	External Trip #2
14) External Trip #3	External Trip #3
15) External Trip #4	External Trip #4
16) Power Factor Trip	Power Factor Trip
17) Frequency Trip	Frequency Trip
18) Phase Overcurrent Alarm	Phase O/C Alarm
19) Ground Overcurrent Alarm	Ground O/C Alarm
20) Overvoltage Alarm	Overvoltage Alarm
21) Undervoltage Alarm	Undervoltage Alarm
22) Analog Input Alarm	Analog Input Alarm
23) Accumulate KA2 Alarm	Accumulated KA Alarm
24) Definite Time Alarm 1	Switch Alarm #1
25) Definite Time Alarm 2	Switch Alarm #2
26) Amps Demand Alarm	Amps Demand Alarm
27) KW Demand Alarm	KW Demand Alarm
28) KVAR Demand Alarm	KVAR Demand Alarm

29) Power Factor Alarm	Power Factor Alarm
30) Frequency Alarm	Frequency Alarm
31) Breaker Discrepancy Alarm	Breaker Discrep. Alarm
32) Trip Coil Alarm	Trip Coil Alarm
33) MTM Communications Alarm	MTM Comm. Alarm
34) Phase Overcurrent Alarm Condition Reset	Phase O/C Alarm Reset
35) Ground Overcurrent Alarm Condition Reset	Ground O/C Alarm Reset
36) Overvoltage Alarm Condition Reset	Overvoltage Alarm Reset
37) Undervoltage Alarm Condition Reset	Undervoltage Alarm Reset
38) Analog Input Alarm Condition Reset	Analog Input Alarm Reset
39) Definite Time Alarm 1 Condition Reset	Switch Alarm#1 Reset
40) Definite Time Alarm 2 Condition Reset	Switch Alarm#2 Reset
41) Breaker Discrepancy Alarm Reset	Breaker Alarm Reset
42) Installation of the Access Jumper	Access Jumper Installed
43) Removal of the Access Jumper	Access Jumper Removed
44) Enable of Block Instantaneous Trip	Block Inst. Trip Enabled
45) Disable of Block Instantaneous Trip	Block Inst. Trip Disabled
46) Enable of Block Timed Overcurrent Trips	Block Timed Trips Enabled
47) Disable of Block Timed Overcurrent Trips	Block Timed Trips Disabled
48) Enable of Overcurrent Curve Adjustment	Curve Adjust. Enabled
49) Disable of Overcurrent Curve Adjustment	Curve Adjust. Disabled
50) Illegal Access to Setpoint	Illegal Setpoint Access
51) System Manual Reset	System Manual Reset
52) Control Switch to Remote	Control Switch to Remote
53) Control Switch to Local	Control Switch to Local

AEG MODICON MODBUS PROTOCOL

Overview

The 565 Feeder Management Relay implements a subset of the AEG Modicon Modbus serial communication standard. Modbus protocol is hardware-independent. That is, the physical layer can be any of a variety of standard hardware configurations. This includes RS232, RS422, RS485, fibre optics, etc. Modbus is a single master/multiple slave type of protocol suitable for a multi-drop configuration as provided by RS485 hardware. The 565 Feeder Management Relay Modbus implementation employs two-wire RS485 hardware. Using RS485, up to 32 slaves can be daisy-chained together on a single communication channel.

565 Feeder Management Relays are always Modbus slaves. They can not be programmed as Modbus masters. Computers or PLCs are commonly programmed as masters.

Modbus protocol exists in two versions: Remote Terminal Unit (RTU, binary) and ASCII. Only the RTU version is supported by the 565 Feeder Management Relay.

Both monitoring and control are possible using read and write register commands. Additional commands are supported to provide additional functions.

This information is also available on diskette for customers who wish to write their own communications programs.

Electrical Interface

The hardware or electrical interface in the 565 Feeder Management Relay is two-wire RS485. In a two-wire link data flow is bidirectional. That is, data is transmitted and received over the same two wires. This means that the data flow is half duplex. That is, data is never transmitted and received at the same time.

RS485 lines should be connected in a daisy chain configuration with terminating resistors installed at each end of the link (ie. at the master end and at the slave farthest from the master). The value of the terminating resistors should be approximately equal to the characteristic impedance of the line. This will be approximately 120 ohms for standard #22 AWG twisted pair wire. Shielded wire should always be used to minimize noise.

Note: polarity is important in RS485 communications. The '+' terminals of every device must be connected together.

Data Frame Format and Rate

One data frame of an asynchronous transmission to or from a 565 Feeder Management Relay consists of 1 start bit, 8 data bits, and 1 stop bit. This produces a 10 bit data frame. This is important for transmission through modems at high bit rates (11 bit data frames are not supported by Hayes

modems at bit rates of greater than 300 bps).

Modbus protocol can be implemented at any standard communication speed. The 565 Feeder Management Relay supports operation at 1200, 2400, 4800 and 9600 baud.

Data Packet Format

A complete request/response sequence consists of the following bytes (transmitted as separate data frames):

Master Request Transmission:

SLAVE ADDRESS	- 1 byte
FUNCTION CODE	- 1 byte
DATA	- variable number of bytes depending on FUNCTION CODE
CRC	- 2 bytes

Slave Response Transmission:

SLAVE ADDRESS	- 1 byte
FUNCTION CODE	- 1 byte
DATA	- variable number of bytes depending on FUNCTION CODE
CRC	- 2 bytes

SLAVE ADDRESS - This is the first byte of every transmission. This byte represents the user-assigned address of the slave device that is to receive the message sent by the master. Each slave device must be assigned a unique address and only the addressed slave will respond to a transmission that starts with its address.

In a master request transmission the **SLAVE ADDRESS** represents the address of the slave to which the request is being sent.

In a slave response transmission the **SLAVE ADDRESS** represents the address of the slave that is sending the response.

NOTE: A master transmission with a **SLAVE ADDRESS** of 0 indicates a broadcast command. All slaves on the communication link will take action based on the transmission but no response will be made.

FUNCTION CODE - This is the second byte of every transmission. Modbus defines function codes of 1 to 127. The 565 Feeder Management Relay implements some of these functions.

In a master request transmission the **FUNCTION CODE** tells the slave what action to perform.

In a slave response transmission if the **FUNCTION CODE** sent from the slave is the same as the **FUNCTION CODE** sent from the master then the slave performed the function as requested. If the high order bit of the **FUNCTION CODE** sent from the slave is a 1 (ie. if the **FUNCTION CODE** is > 127) then the slave did not perform the function as requested and is sending an error or exception response.

DATA - This will be a variable number of bytes depending on the **FUNCTION CODE**. This may be addresses, actual values or setpoints, sent by the master to the slave or by the slave to the master.

CRC - This is a two byte error checking code.

Error Checking

The RTU version of Modbus includes a two byte CRC-16 (16 bit cyclic redundancy check) with every transmission. The CRC-16 algorithm essentially treats the entire data stream (data bits only; start, stop and parity ignored) as one continuous binary number. This number is first shifted left 16 bits and then divided by a characteristic polynomial (1100000000000101B). The 16 bit remainder of the division is appended to the end of the transmission, MSByte first. The resulting message including CRC, when divided by the same polynomial at the receiver will give a zero remainder if no transmission errors have occurred.

If a 565 Feeder Management Relay Modbus slave device receives a transmission in which an error is indicated by the CRC-16 calculation, the slave device will not respond to the transmission. A CRC-16 error indicates that one or more bytes of the transmission were received incorrectly and thus the entire transmission should be ignored in order to avoid the slave device performing any incorrect operation.

The CRC-16 calculation is an industry standard method used for error detection. An algorithm is included here to assist programmers in situations where no standard CRC-16 calculation routines are available.

CRC-16 Algorithm

Once the following algorithm is complete, the working register "A" will contain the CRC value to be transmitted. Note that this algorithm requires the characteristic polynomial to be reverse bit ordered. The MSbit of the characteristic polynomial is dropped since it does not affect the value of the remainder. The following symbols are used in the algorithm:

—> data transfer
 A 16 bit working register
 AL low order byte of A
 AH high order byte of A
 CRC 16 bit CRC-16 value
 i,j loop counters
 (+) logical "exclusive or" operator
 Di i-th data byte (i = 0 to N-1)
 G 16 bit characteristic polynomial = 1010000000000001 with MSbit dropped and bit order reversed
 shr(x) shift right (the LSbit of the low order byte of x shifts into a carry flag, a '0' is shifted into the MSbit of the high order byte of x, all other bits shift right one location)

algorithm:

1. FFFF hex —> A
2. 0 —> i
3. 0 —> j
4. Di (+) AL —> AL
5. j+1 —> j
6. shr(A)
7. is there a carry? No: go to 8.
 Yes: G (+) A —> A
8. is j = 8? No: go to 5.
 Yes: go to 9.

9. i+1 —> i
10. is i = N? No: go to 3.
 Yes: go to 11.
11. A —> CRC

Timing

Data packet synchronization is maintained by timing constraints. The receiving device must measure the time between the reception of characters. If three and one half character times elapse without a new character or completion of the packet, then the communication link must be reset (ie. all slaves start listening for a new transmission from the master). Thus at 9600 baud a delay of greater than $3.5 \times 1/9600 \times 10 = 3.65$ ms will cause the communication link to be reset.

Explanation of 565 Supported Functions

The following functions are supported by the 565 Feeder Management Relay:

- 03 - Read Holding Registers (Read Setpoints)
- 04 - Read Input registers (Read Actual Values)
- 05 - Force Single Coil (Execute Operation)
- 06 - Preset Single Register (Store Single Setpoint)
- 07 - Read Exception Status (Read Device Status)
- 16 - Preset Multiple Registers (Store Multiple Setpoints)

FUNCTION CODE 03

Modbus implementation: Read Holding Registers
 565 Feeder Management Relay implementation: Read Setpoints

This function code allows the master to read a group of setpoints from a slave device. The maximum number of holding registers that can be read in one transmission is 125. Number of holding registers should match the total length of required setpoints. In other words, reading half of a setpoint is not recommended. For the 565 Feeder Management Relay implementation of Modbus, "holding registers" are equivalent to 565 Feeder Management Relay setpoints. Holding registers are 16 bit (two byte) values transmitted high order byte first. But all 565 Feeder Management Relay setpoints are not made of two bytes. Some of them are four bytes long and in that case two consecutive holding register addresses are used to transmit data of one setpoint. Holding register with lower address number carries two more significant bytes.

The slave response to this function code is the slave address, function code, a count of the number of data bytes to follow, the data itself and the CRC. Each data item (setpoint) is sent as a two byte number with the high order byte sent first.

Note: Broadcast mode is not allowed with this function code. The master transmission will be ignored by all slaves if broadcast mode is used with this function code.

FEATURE INFORMATION



Message Format and Example (numbers are expressed in HEX)

Request slave 11 to respond with 3 setpoints starting at address 006B. For this example the setpoints data in these addresses is:

Address	Data
006B	022B
006C	0000
006D	0064

Master Transmission:

11	03	HI LO	HI LO	HI LO
ADDRESS	FUNCTION CODE	START ADDRESS	SETPOINT COUNT	CRC
11	03	00 6B	00 03	?? ??

Slave Response:

11	03	06	HI LO	HI LO	HI LO	HI LO
ADDRESS	FUNCTION CODE	BYTE COUNT	02 2B	00 00	00 64	?? ??
			DATA	DATA	DATA	CRC
11	03	06	02 2B	00 00	00 64	?? ??

FUNCTION CODE 04

Modbus Implementation: Read Input Registers
565 Feeder Management Relay Implementation: Read Actual Values

This function code allows the master to read a group of actual values from a slave device. The maximum number of input registers that can be read in one transmission is 125. Number of input registers should match the total length of required actual values. In other words, reading half of an actual value is not recommended. For the 565 Feeder Management Relay implementation of Modbus, "input registers" are equivalent to 565 Feeder Management Relay actual values. Input registers are 16 bit (two byte) values transmitted high order byte first. But all 565 Feeder Management Relay actual values are not made of two bytes. Some of them are four bytes long and in that case two consecutive input register addresses are used to transmit data of one actual value. Input register with lower address number carries two more significant bytes.

The slave response to this function code is the slave address, function code, a count of the number of data bytes to follow, the data itself, and the CRC. Each data item (actual value) is sent as a two byte number with the high order byte sent first.

Note: Broadcast mode is not allowed with this function code. The master transmission will be ignored by all slaves if broadcast mode is used with this function code.

Message Format and Example

Request slave 11 to respond with 1 actual value starting at address 0008. For this example the actual value in this address (0008) is 0000.

Master Transmission:

11	04	HI LO	HI LO	HI LO
ADDRESS	FUNCTION CODE	START ADDRESS	ACT. VAL. COUNT	CRC
11	04	00 08	00 01	?? ??

Slave Response:

11	04	02	HI LO	HI LO
ADDRESS	FUNCTION CODE	BYTE COUNT	00 00	?? ??
			DATA	CRC
11	04	02	00 00	?? ??

FUNCTION CODE 05

Modbus Implementation: Force Single Coil
565 Feeder Management Relay Implementation: Execute Operation

This function code allows the master to request the 565 Feeder Management Relay to perform specific operations. The operations that can be performed by the 565 Feeder Management Relay are as follows:

Operation Code	Function
00	Reset (keypad)
01	End of Relay Test
02	End of LED Test
03	End of Analog Output Test
04	Test LCD Display
05	Test LEDs
0FH	Clear Maintenance Data
10H	Clear Operations Data
11H	Clear Amp Demand Data
12H	Clear KW Demand Data
13H	Clear KVAR Demand Data
14H	Clear Events

Note: Broadcast mode is allowed with this function code. When a broadcast transmission is sent by the master (ie. SLAVE ADDRESS = 0) the selected operation will be executed by all slave devices on the communication link. No response will be sent from any of the slaves.

Message Format and Example

Request slave 11 to execute operation code 1.

Master Transmission:

11	05	HI LO	HI LO	HI LO
ADDRESS	FUNCTION CODE	OPERATION CODE	CODE VALUE	CRC
11	05	00 01	FF 00	?? ??

(Perform Function)

Slave Response:

11	05	HI LO	HI LO	HI LO
ADDRESS	FUNCTION CODE	OPERATION CODE	CODE VALUE	CRC
11	05	00 01	FF 00	?? ??

FUNCTION CODE 06

Modbus Implementation: Preset Single Register
565 Feeder Management Relay Implementation: Store Sin-

gle Setpoint

This command allows the master to store a single setpoint into the memory of a slave device. Only two bytes setpoints can be stored via this function. The slave device response to this function code is to echo the entire master transmission.

Note: Broadcast mode is allowed with this function code. When a broadcast transmission is sent by the master (ie. SLAVE ADDRESS = 0) the selected setpoint will be stored by all slave devices on the communication link. No response will be sent from any of the slaves.

Message Format and Example

Request slave 11 to store the value 039E in setpoint address 0087. After the transmission in this example is complete, setpoints address 0087 will contain the value 039E.

Master Transmission:

11	06	HI LO 00 87	HI LO 03 9E	HI LO ?? ??
ADDRESS	FUNCTION CODE	START ADDRESS	DATA	CRC

Slave Response:

11	06	HI LO 00 87	HI LO 03 9E	HI LO ?? ??
ADDRESS	FUNCTION CODE	START ADDRESS	DATA	CRC

FUNCTION CODE 07

Modbus Implementation: Read Exception Status
565 Feeder Management Relay Implementation: Read Device Status

This is a function used to quickly read the status of a selected device. A short message length allows for rapid reading of status. The status byte returned will have individual bits set to 1 or 0 depending on the status of the slave device.

Note: Broadcast mode is not allowed with this function code. The master transmission will be ignored by all slaves if broadcast mode is used with this function code.

Message Format and Example

Request status from slave 11.

Master Transmission:

11	07	HI LO ?? ??
ADDRESS	FUNCTION CODE	CRC

Slave Response:

11	07	6D	HI LO ?? ??
ADDRESS	FUNCTION CODE	DEVICE STATUS	CRC
= 01101101			

FUNCTION CODE 16

Modbus Implementation: Preset Multiple Registers
565 Feeder Management Relay Implementation: Store Multiple Setpoints

This function code allows the master to store a group of setpoints. The maximum number of holding registers that can be stored in one transmission is 60. Number of holding registers has to match the total length of required setpoints. In the other words writing half of a setpoint is not allowed. Modbus "registers" are 16 bit (two byte) values transmitted high order byte first. But all 565 Feeder Management Relay setpoints are not made of two bytes. Some of them are four bytes long and in that case two consecutive holding register addresses are used to transmit data of one setpoint. Holding register with lower address number carries two more significant bytes. The slave device response to this function code is to echo the slave address, function code, starting address, the number of setpoints loaded, and the CRC.

Note: Broadcast mode is allowed with this function code. When a broadcast transmission is sent by the master (ie. SLAVE ADDRESS = 0) the selected setpoint(s) will be stored by all slave devices on the communication link. No response will be sent from any of the slaves.

Message Format and Example

Request slave 11 to store the value 000A to setpoint address 0087 and the value 0102 to setpoint address 0088. After the transmission in this example is complete, 565 Feeder Management Relay slave 11 will have the following setpoints information stored:

Address	Data
0087	000A
0088	0102

Master Transmission:

11	10	HI LO 00 87	HI LO 00 02	04	HI LO 00 0a	HI LO 01 02	HI LO ?? ??
ADDRESS	FUNCTION CODE	START ADDRESS	SETPOINT COUNT	BYTE COUNT	DATA	DATA	CRC

Slave Response:

11	10	HI LO 00 87	HI LO 00 02	HI LO ?? ??
ADDRESS	FUNCTION CODE	START ADDRESS	SETPOINT COUNT	CRC

Error Responses

When a 565 Feeder Management Relay detects an error other than a CRC error, a response will be sent to the master. The MSbit of the FUNCTION CODE byte will be set to 1 (ie. the function code sent from the slave will be equal to the function code sent from the master plus 128). The following byte will be an exception code indicating the type of error that occurred. Transmissions received from the master with CRC errors will be ignored by the 565 Feeder Management Relay.

FEATURE INFORMATION



The slave response to an error (other than CRC error) will be:

SLAVE ADDRESS	- 1 byte
FUNCTION CODE	- 1 byte (with MSbit set to 1)
EXCEPTION CODE	- 1 byte
CRC	- 2 bytes

The 565 Feeder Management Relay implements or reserves the following exception response codes:

01 - ILLEGAL FUNCTION

The function code transmitted is not one of the functions supported by the 565 Feeder Management Relay.

02 - ILLEGAL DATA ADDRESS

The address referenced in the data field transmitted by the master is not an allowable address for the 565 Feeder Management Relay, or requested number of registers does not match total length of referenced internal registers.

03 - ILLEGAL DATA VALUE

The value referenced in the data field transmitted by the master is not within range for the selected data address. Could be implemented in the future.

04 - FAILURE IN ASSOCIATED DEVICE

A device connected to the addressed slave device has failed and the data requested cannot be sent.

06 - BUSY, REJECTED MESSAGE

The transmission was received without error but the request could not be performed. Reserved.

08 - MEMORY PARITY ERROR

A hardware error has occurred in the 565 Feeder Management Relay. For example, a RAM failure has occurred and the data requested cannot be sent. Reserved.

565/575 MEMORY MAP (REVISION E2.73)									
ADDRESS (DEC)	ADDRESS (HEX)	GROUP	DESCRIPTION	RANGE	STEP	UNITS	SCALE	FORMAT CODE	FACTORY DEFAULT
Actual Values - READ ONLY									
0000	0000	PRODUCT I.D.	MULTILIN PRODUCT DEVICE CODE	18 or 58	---	---	---	F1	18 (565), 58 (575)
0001	0001		565/575 HARDWARE REVISION	A to Z	---	---	---	F2	E
0002	0002		565/575 FIRMWARE REVISION	0.00 to 2.73	---	---	---	F3	2.73
0003	0003		565/575 FIRMWARE MODIFICATION	0 to 508	---	---	---	F4	0
0004	0004		RESERVED						
:	:		:						
0024	0018		RESERVED						
0025	0019	STATUS	START OF EVENT QUEUE (POINTER TO MOST RECENT EVENT)	---	---	---	---	F5	---
0026	001A		565/575 TRIP STATUS	0 or 1	---	---	---	F6	0
0027	001B		BREAKER POSITION STATUS	16 or 32	---	---	---	F7	---
0028	001C		ALARM STATUS I	---	---	---	---	F8	---
0029	001D		ALARM STATUS II	---	---	---	---	F9	---
0030	001E		EXTERNAL SWITCH STATUS	---	---	---	---	F10	---
0031	001F		OUTPUT CONTACT STATUS	---	---	---	---	F11	---
0032	0020	CURRENT	PHASE A CURRENT	0 TO 100000	---	AMPS	0.01	F12	---
0034	0022		PHASE B CURRENT	0 TO 100000	---	AMPS	0.01	F12	---
0036	0024		PHASE C CURRENT	0 TO 100000	---	AMPS	0.01	F12	---
0038	0026		GROUND CURRENT	0 TO 100000	---	AMPS	0.01	F12	---
0040	0028		SEE ACTUAL VALUES VOLTAGE GROUP						
:	:		:						
0043	002B	ANALOG INPUT	SEE ACTUAL VALUES VOLTAGE GROUP						
0044	002C		ANALOG INPUT	---	---	---	0.01	F12	---
0046	002E		RESERVED						
:	:		:						
0047	002F		RESERVED						
0048	0030	MAINTENANCE DATA	BREAKER DATE	---	---	---	---	F13	---
0050	0032		BREAKER TRIPS	0 TO 10000	---	---	1.00	F14	---
0051	0033		PHASE A ACCUMULATED KA	0 TO 9999999	---	KA ²	0.01	F12	---
0053	0035		PHASE B ACCUMULATED KA	0 TO 9999999	---	KA ²	0.01	F12	---
0055	0037		PHASE C ACCUMULATED KA	0 TO 9999999	---	KA ²	0.01	F12	---
0057	0039		MAINTENANCE DATA CLEAR? (RESERVED)						
0058	003A		DATA CLEARED LAST:	---	---	---	---	F13	---
0060	003C	OPERATIONS DATA	TIMED PHASE O/C TRIPS	0 TO 10000	---	---	1.00	F14	---
0061	003D		INST PHASE O/C TRIPS	0 TO 10000	---	---	1.00	F14	---
0062	003E		TIMED GROUND O/C TRIPS	0 TO 10000	---	---	1.00	F14	---
0063	003F		INST GROUND O/C TRIPS	0 TO 10000	---	---	1.00	F14	---
0064	0040		OVERVOLTAGE TRIPS	0 TO 10000	---	---	1.00	F14	---
0065	0041		UNDERVOLTAGE TRIPS	0 TO 10000	---	---	1.00	F14	---
0066	0042		ANALOG INPUT TRIPS	0 TO 10000	---	---	1.00	F14	---
0067	0043		CLEAR OPERATIONS DATA? (RESERVED)						
0068	0044		DATA CLEARED LAST?	---	---	---	---	F13	---
0070	0046		RESERVED						
:	:		:						
0071	0047		RESERVED						
0072	0048	PRETRIP DATA	CAUSE OF LAST TRIP	---	---	---	---	F15	---
0074	004A		PHASE A PRE-TRIP CURRENT	0 TO 100000	---	AMPS	0.01	F12	---
0076	004C		PHASE B PRE-TRIP CURRENT	0 TO 100000	---	AMPS	0.01	F12	---
0078	004E		PHASE C PRE-TRIP CURRENT	0 TO 100000	---	AMPS	0.01	F12	---
0080	0050		GROUND PRE-TRIP CURRENT	0 TO 100000	---	AMPS	0.01	F12	---
0082	0052		PHASE A-X PRE-TRIP VOLTAGE	0 TO 431.25	---	KVOLTS	0.01	F14	---
0083	0053		PHASE B-X PRE-TRIP VOLTAGE	0 TO 431.25	---	KVOLTS	0.01	F14	---
0084	0054		PHASE C-X PRE-TRIP VOLTAGE	0 TO 431.25	---	KVOLTS	0.01	F14	---
0085	0055		FREQUENCY AT TRIP	---	---	Hz	0.01	F14	---
0086	0056		DATE OF TRIP	---	---	---	---	F13	---
0088	0058		TIME OF TRIP	---	---	---	---	F13	---

565/575 MEMORY MAP (REVISION E2.73)										
ADDRESS (DEC)	ADDRESS (HEX)	GROUP	DESCRIPTION	RANGE	STEP	UNITS	SCALE	FORMAT CODE	FACTORY DEFAULT	
Actual Values - READ ONLY										
0090	005A	VOLTAGE	RESERVED							
:	:									
0091	005B		RESERVED							
0040	0028		VOLTS PHASE A-X	0 TO 431.25	---	KVOLTS	0.01	F14	---	
0041	0029		VOLTS PHASE B-X	0 TO 431.25	---	KVOLTS	0.01	F14	---	
0042	002A		VOLTS PHASE C-X	0 TO 431.25	---	KVOLTS	0.01	F14	---	
0043	002B		FREQUENCY OF FEEDER	---	---	Hz	0.01	F14	---	
0092	005C		SEE ACTUAL VALUES DEMAND & METERING DATA							
:	:									
0114	0072		EVENT	SEE ACTUAL VALUES DEMAND & METERING DATA						
0115	0073	RESERVED								
0116	0074	NO. OF EVENTS:		0 TO 40	---	---	1.00	F14	---	
0117	0075	VIEW EVENTS? (RESERVED)								
0118	0076	RESERVED								
0119	0077	PRINT EVENTS? (RESERVED)								
0120	0078	CLEAR EVENTS? (RESERVED)								
0121	0079	EVENTS CLEARED LAST:		---	---	---	---	F13	---	
0092	005C	DEMAND DATA		PH-A PEAK DEMAND	---	---	AMPS	0.01	F12	---
0094	005E			PH-B PEAK DEMAND	---	---	AMPS	0.01	F12	---
0096	0060		PH-C PEAK DEMAND	---	---	AMPS	0.01	F12	---	
0098	0062		CLEAR AMP DEMAND DATA? (RESERVED)							
0099	0063		DATA CLEARED LAST:	---	---	---	---	F13	---	
0101	0065	METERING DATA	PEAK KW DEMAND	---	---	KW	1.00	F14	---	
0102	0066		CLEAR KW DEMAND DATA? (RESERVED)							
0103	0067		KW DEMAND DATA CL'D:	---	---	---	---	F13	---	
0105	0069		PEAK KVAR DEMAND	---	---	KVAR	1.00	F14	---	
0106	006A		CLEAR KVAR DEM'D DATA? (RESERVED)							
0107	006B		KVAR DEMAND DATA CL'D:	---	---	---	---	F13	---	
0109	006D		KW AND KVAR POWER SIGNS	---	---	---	---	F16	---	
0110	006E		POWER FACTOR	---	---	---	0.01	F17	---	
0111	006F		FREQUENCY MTM	---	---	Hz	0.10	F14	---	
0112	0070		REAL POWER	0 TO +/- 65535	---	KW	1.00	F18	---	
0113	0071	REACTIVE POWER	0 TO +/- 65535	---	KVAR	1.00	F18	---		
0114	0072	REAL ENERGY USED	---	---	MWHR	1.00	F14	---		
0123	007B	RESERVED								
:	:									
0255	00FF	RESERVED								
Setpoints - READ/WRITE										
0256	0100	USER LEVEL	USER LEVEL	0 or 1	-	-	-	F19	1	
0257	0101		SECURITY FEATURE	0 or 1	-	-	-	F20	1	
0258	0102		SETPOINT ACCESS	0 or 1	-	-	-	F20	0	
0259	0103	RESERVED								
0260	0104	PHASE CURRENT	PHASE CT RATING PRIMARY	10 - 5000	5	AMPS	1.00	F14	100	
0261	0105		SEE SETPOINTS PHASE CURRENT GROUP							
0262	0106		PHASE TIMED O/C PICKUP	25 - 250	1	%CT	1.00	F14	100	
0261	0105		PHASE O/C CURVE SHAPE (565) or PH. O/C CURVE 1 SHAPE (575)	0 - 7	-	-	-	F21	3	
0263	0107		PHASE O/C TIME DIAL (565) or PHASE O/C TIME DIAL 1 (575)	1 - 32	1	-	1.00	F14	1	
0264	0108		PHASE O/C TRIP RELAY	0 - 6	-	-	-	F22	0 (565), 1 (575)	
0265	0109		PHASE O/C ALARM	0 or 1	-	-	-	F20	1	
0266	010A		PHASE O/C ALARM LEVEL	0.5 - 3.0	0.1	X P/U	0.10	F14	1.5	
0267	010B		PHASE O/C ALARM DELAY	1 - 255	1	SEC	1.00	F14	1	
0268	010C		PHASE O/C ALARM RELAY	0 - 3	-	-	-	F23	0 (565), 1 (575)	
0269	010D		PHASE INST TRIPS (565) or PHASE HISET INST TRIPS (575)	0 or 1	-	-	-	F20	0	
0270	010E		PHASE INST TRIP LEVEL (565) or PHASE HISET INST TRIP LEVEL (575)	1.0 - 18.0	0.1	X P/U	0.10	F14	3.0	
0271	010F		PHASE INST TRIP DELAY (565) or PHASE HISET INST DELAY (575)	0 - 40	1	CYC	1.00	F14	0	
0272	0110		PHASE INST TRIP RELAY (565) or PHASE HISET INST RELAY (575)	0 - 6	-	-	-	F22	0 (565), 1 (575)	
0273	0111		(575 Only) PH AUTOBLK INST HISET	0 or 1	-	-	-	F20	1	
0274	0112		(575 Only) PH AUTOBLK HISET AFTER RECL.#	1 - 4	1	-	1.00	F14	4	
0275	0113		(575 Only) PHASE LOSET INST TRIPS	0 or 1	-	-	-	F20	0	
0276	0114		(575 Only) PHASE LOSET INST TRIP LEVEL	1.0 - 18.0	0.1	X P/U	0.10	F14	2.0	
0277	0115	(575 Only) PHASE LOSET INST DELAY	0 - 40	1	CYC	1.00	F14	0		
0278	0116	(575 Only) PHASE LOSET INST RELAY	0 - 2	-	-	-	F22	1		
0279	0117	(575 Only) PH AUTOBLK INST LOSET	0 or 1	-	-	-	F20	1		
0280	0118	(575 Only) PH AUTOBLK LOSET AFTER RECL.#	1 - 4	1	-	1.00	F14	4		

565/575 MEMORY MAP (REVISION E2.73)									
ADDRESS (DEC)	ADDRESS (HEX)	GROUP	DESCRIPTION	RANGE	STEP	UNITS	SCALE	FORMAT CODE	FACTORY DEFAULT
Actual Values - READ ONLY									
0281	0119		TRIP TIME (SEC) (RESERVED)						
0282	011A		RESERVED						
:	:		:						
0299	012B		RESERVED						
0300	012C	GROUND CURRENT	GROUND CURRENT SENSING	0 or 1	-	-	-	F20	0
0301	012D		SENSING SYSTEM	0 or 1	-	-	-	F24	0
0302	012E		CT RATIO PRIMARY	10 - 5000	5	AMPS	1.00	F14	100
0303	012F		SEE SETPOINTS GROUND CURRENT GROUP						
0304	0130		GROUND TIMED O/C PICKUP	5 - 150	1	% CT	1.00	F14	40
0303	012F		GND O/C CURVE SHAPE (565) or GND O/C CURVE 1 SHAPE (575)	0 - 7	-	-	-	F21	3
0305	0131		GROUND O/C TIME DIAL (565) or GROUND O/C TIME DIAL 1 (575)	1 - 32	1	-	1.00	F14	1
0306	0132		GROUND O/C RELAY	0 - 6	-	-	-	F22	0 (565), 1 (575)
0307	0133		GROUND O/C ALARM	0 or 1	-	-	-	F20	1
0308	0134		GND O/C ALARM LEVEL	0.5 - 3.0	0.1	X P/U	0.10	F14	1.5
0309	0135		GND O/C ALARM DELAY	1 - 255	1	SEC	1.00	F14	1
0310	0136		GND O/C ALARM RELAY	0 - 3	-	-	-	F23	0 (565), 1 (575)
0311	0137		GROUND INST TRIPS (565) or GND HISET INST TRIPS (575)	0 or 1	-	-	-	F20	0
0312	0138		GND INST TRIP LEVEL (565) or GND HISET INST TRIP LEVEL (575)	1.0 - 7.0	0.1	X P/U	0.10	F14	3.0
0325	0145		GND INST TRIP 2 LEVEL (565) or GND HISET INST TRIP2 LEVEL (575)	1.0 - 18.0	0.1	X P/U	0.10	F14	3.0
0313	0139		GND INST TRIP DELAY (565) or GND HISET INST DELAY (575)	0 - 40	1	CYC	1.00	F14	0
0314	013A		GND INST TRIP RELAY (565) or GND HISET INST RELAY (575)	0 - 6	-	-	-	F22	0 (565), 1 (575)
0315	013B	(575 Only)	GND AUTOBLK INST HISET	0 or 1	-	-	-	F20	1
0316	013C	(575 Only)	GND AUTOBLK HISET AFTER RECL.#	1 - 4	1	-	1.00	F14	4
0317	013D	(575 Only)	GND LOSET INST TRIPS	0 or 1	-	-	-	F20	0
0318	013E	(575 Only)	GND LOSET INST TRIP LEVEL	1.0 - 7.0	0.1	X P/U	0.10	F14	3.0
0326	0146	(575 Only)	GND LOSET INST TRIP2 LEVEL	1.0 - 18.0	0.1	X P/U	0.10	F14	3.0
0319	013F	(575 Only)	GND LOSET INST DELAY	0 - 40	1	CYC	1.00	F14	0
0320	0140	(575 Only)	GND LOSET INST RELAY	0 - 2	-	-	-	F22	1
0321	0141	(575 Only)	GND AUTOBLK INST LOSET	0 or 1	-	-	-	F20	1
0322	0142	(575 Only)	GND AUTOBLK LOSET AFTER RECL.#	1 - 4	1	-	1.00	F14	4
0323	0143		TRIP TIME (SEC) (RESERVED)						
0324	0144		RESERVED						
0325	0145		SEE SETPOINTS GROUND CURRENT GROUP						
:	:		:						
0326	0146		SEE SETPOINTS GROUND CURRENT GROUP						
0327	0147		RESERVED						
:	:		:						
0328	0148		RESERVED						
0329	0149	CONFIGURATION	SEE SETPOINTS CONFIGURATION GROUP						
:	:		:						
0339	0153		SEE SETPOINTS CONFIGURATION GROUP						
0340	0154		SET TIME	-	-	-	-	F13	-
0342	0156		SET DATE	-	-	-	-	F13	-
0344	0158		RESET BLOCKED	0 - 8	-	-	-	F26	0
0345	0159		BLOCK INST TRIPS	0 - 8	-	-	-	F26	0
0346	015A		BLOCK TIMED O/C TRIPS	0 - 8	-	-	-	F26	0
0339	0153		BLOCK GND TRIPS	0 - 8	-	-	-	F26	0
0347	015B		DEFINITE TIME #1 ALARM	0 - 8	-	-	-	F26	0
0348	015C		DEFINITE TIME #1 DELAY	1 - 255	1	SEC	1.00	F14	1
0349	015D		DEFINITE TIME #1 RELAY	0 - 3	-	-	-	F23	1 (565), 2 (575)
0373	0175		DEFINITE TIME #2 ALARM	0 - 8	-	-	-	F26	0
0374	0176		DEFINITE TIME #2 DELAY	1 - 255	1	SEC	1.00	F14	1
0375	0177		DEFINITE TIME #2 RELAY	0 - 3	-	-	-	F23	1 (565), 2 (575)
0350	015E		EXTERNAL TRIP #1 (565) or EXTERNAL TRIP (575)	0 - 8	-	-	-	F26	0
0351	015F		EXTERNAL TRIP #1 RELAY (565) or EXTERNAL TRIP RELAY (575)	0 - 6	-	-	-	F22	3 (565), 1 (575)
0329	0149	(565 Only)	EXTERNAL TRIP #1 DELAY	0 - 60	1	CYC	1.00	F14	0
0352	0160		SEE SETPOINTS CONFIGURATION GROUP						
:	:		:						
0362	016A		SEE SETPOINTS CONFIGURATION GROUP						
0363	016B		RESERVED						
:	:		:						
0364	016C		RESERVED						
0365	016D		SEE SETPOINTS CONFIGURATION GROUP						
:	:		:						
0375	0177		SEE SETPOINTS CONFIGURATION GROUP						
0376	0178		EXTERNAL TRIP #2 (565) or RECLOSABLE TRIP (575)	0 - 8	-	-	-	F26	0
0377	0179		EXTERNAL TRIP #2 RELAY (565) or RECLOSABLE TRIP RELAY (575)	0 - 6	-	-	-	F22	3 (565), 1 (575)
0330	014A	(565 Only)	EXTERNAL TRIP #2 DELAY	0 - 60	1	CYC	1.00	F14	0
0378	017A		EXTERNAL TRIP #3 (565) or PROGRAMMABLE TRIP (575)	0 - 8	-	-	-	F26	0
0379	017B		EXTERNAL TRIP #3 RELAY (565) or PROGRAMMABLE TRIP RELAY (575)	0 - 6	-	-	-	F22	3 (565), 1 (575)

565/575 MEMORY MAP (REVISION E2.73)									
ADDRESS (DEC)	ADDRESS (HEX)	GROUP	DESCRIPTION	RANGE	STEP	UNITS	SCALE	FORMAT CODE	FACTORY DEFAULT
Actual Values - READ ONLY									
0331	014B	(565 Only)	EXTERNAL TRIP #3 DELAY	0 - 60	1	CYC	1.00	F14	0
0380	017C	(575 Only)	PROGRAMABLE TRIP TYPE	0 or 1	-	-	-	F27	0
0332	014C	(565 Only)	EXTERNAL TRIP #4	0 - 8	-	-	-	F26	0
0333	014D	(565 Only)	EXTERNAL TRIP #4 RELAY	0 - 6	-	-	-	F22	3 (565), 1 (575)
0334	014E	(565 Only)	EXTERNAL TRIP #4 DELAY	0 - 60	1	CYC	1.00	F14	0
0352	0160		CURVE ADJUSTMENT	0 - 8	-	-	-	F26	0
0380	017C		SEE SETPOINTS CONFIGURATION GROUP						
0381	017D	(575 Only)	ALTERNATE PHASE CURVE	0 - 8	-	-	-	F26	0
0382	017E	(575 Only)	ALTERNATE GROUND CURVE	0 - 8	-	-	-	F26	0
0383	017F	(575 Only)	AUTO-RECLOSURE BLOCK	0 - 8	-	-	-	F26	0
0384	0180		EXTERNAL RESET	0 - 8	-	-	-	F26	0
0353	0161		SW 1 CONTACT: NORMALLY	0 or 1	-	-	-	F28	0
0354	0162		SW 2 CONTACT: NORMALLY	0 or 1	-	-	-	F28	0
0355	0163		SW 3 CONTACT: NORMALLY	0 or 1	-	-	-	F28	0
0356	0164		SW 4 CONTACT: NORMALLY	0 or 1	-	-	-	F28	0
0385	0181		SW 5 CONTACT: NORMALLY	0 or 1	-	-	-	F28	0
0386	0182		SW 6 CONTACT: NORMALLY	0 or 1	-	-	-	F28	0
0387	0183		SW 7 CONTACT: NORMALLY	0 or 1	-	-	-	F28	0
0388	0184		SW 8 CONTACT: NORMALLY	0 or 1	-	-	-	F28	0
0357	0165	(565 Only)	TRIP RELAY	0 or 1	-	-	-	F29	1
0358	0166	(565 Only)	TRIP RELAY PULSE TIME	0.1 - 0.6	0.1	SEC	0.10	F14	0.6
0359	0167		AUX 1 RELAY	0 - 2	-	-	-	F30	1 (565), 2 (575)
0360	0168		AUX 1 RELAY PULSE TIME	0.1 - 0.6	0.1	SEC	0.10	F14	0.6 (565), 0.1 (575)
0361	0169		AUX 2 RELAY	0 - 2	-	-	-	F30	1
0362	016A		AUX 2 RELAY PULSE TIME	0.1 - 0.6	0.1	SEC	0.10	F14	0.6
0365	016D		BREAKER RESPONSE DELAY	1 - 167	1	ms	1.00	F14	1
0335	014F	(565 Only)	BREAKER DISCREP.	0 or 1	-	-	-	F20	1
0389	0185		BREAKER DISCREP. DELAY	100 - 1000	10	ms	1.00	F14	1000
0338	0152		TRIP COIL SUPER-VISION	0 or 1	-	-	-	F20	1
0366	016E		ACCUMULATED KA ALARM	0 or 1	-	-	-	F20	1
0367	016F		ACCUMULATED KA ALARM LEVEL	5000 - 100000	10	kA	1.00	F12	5000
0369	0171		KA ALARM RELAY	0 - 3	-	-	-	F23	0
0370	0172		EVENT RECORDING	0 or 1	-	-	-	F20	0
0371	0173		EVENT PRINTING	0 or 1	-	-	-	F31	0
0336	0150	(575 Only)	COLD LOAD P/U BLOCK	0 - 2	-	-	-	F25	0
0337	0151		COLD LOAD P/U DELAY	0.0 - 10.0	0.1	SEC	0.10	F14	0.0
0372	0174		MTM COMM.:	0 or 1	-	-	-	F20	0
0390	0186	ANALOG INPUT	ANALOG INPUT:	0 or 1	-	-	-	F20	1
0391	0187		EDIT ANALOG INPUT TITLE? (RESERVED)						
0392	0188		EDIT ANALOG INPUT UNITS? (RESERVED)						
0393	0189		MIN CURR SCALE VALUE:	0.00 - 1023.00	0.01	-	0.01	F12	4.00
0395	018B		MAX CURR SCALE VALUE	0.00 - 1023.00	0.01	-	0.01	F12	20.00
0397	018D		ANALOG INPUT TRIP	0 or 1	-	-	-	F20	1
0398	018E		ANALOG IN TRIP LEVEL	(See 393 to 396 _{DEC})	-	-	-	F32	16.00
0400	0190		ANALOG IN TRIP DELAY	1 - 255	1	SEC	1.00	F14	1
0401	0191		ANALOG IN TRIP RELAY	0 - 6	-	-	-	F22	0 (565), 1 (575)
0402	0192		ANALOG INPUT ALARM	0 or 1	-	-	-	F20	1
0403	0193		ANALOG IN ALARM LEVEL	(See 393 to 396 _{DEC})	-	-	-	F32	12.00
0405	0195		ANALOG IN ALARM DELAY	1 - 255	1	SEC	1.00	F14	1
0406	0196		ANALOG IN ALARM RELAY	0 - 3	-	-	-	F23	0 (565), 2 (575)
0407	0197		RESERVED						
:	:		RESERVED						
0419	01A3		RESERVED						
0420	01A4	ANALOG OUTPUT	ANALOG OUTPUT PARAMETER	0 - 8	-	-	-	F33	0
0421	01A5		ANALOG OUTPUT RANGE	0 or 1	-	-	-	F34	1
0422	01A6		RESERVED						
:	:		RESERVED						
0429	01AD		RESERVED						
0430	01AE	COMMUNICATIONS	RELAY ADDRESS	1 - 254	1	-	1.00	F14	1
0431	01AF		BAUDRATE	0 - 3	-	-	-	F35	1
0432	01B0		RESERVED						
:	:		RESERVED						
0439	01B7		RESERVED						
0440	01B8	CALIBRATION MODE	EXERCISE RELAY	0 - 6	-	-	-	F36	0
0441	01B9		SWITCH NUMBER 1 STATUS	0 or 1	-	-	-	F28	0
0442	01BA		SWITCH NUMBER 2 STATUS	0 or 1	-	-	-	F28	0
0443	01BB		SWITCH NUMBER 3 STATUS	0 or 1	-	-	-	F28	0

565/575 MEMORY MAP (REVISION E2.73)									
ADDRESS (DEC)	ADDRESS (HEX)	GROUP	DESCRIPTION	RANGE	STEP	UNITS	SCALE	FORMAT CODE	FACTORY DEFAULT
Actual Values - READ ONLY									
0444	01BC		SWITCH NUMBER 4 STATUS	0 or 1	-	-	-	F28	0
0471	01D7		SWITCH NUMBER 5 STATUS	0 or 1	-	-	-	F28	0
0472	01D8		SWITCH NUMBER 6 STATUS	0 or 1	-	-	-	F28	0
0473	01D9		SWITCH NUMBER 7 STATUS	0 or 1	-	-	-	F28	0
0474	01DA		SWITCH NUMBER 8 STATUS	0 or 1	-	-	-	F28	0
0445	01BD		BREAKER OPEN STATUS	0 or 1	-	-	-	F37	0
0446	01BE		BREAKER CLOSED STATUS	0 or 1	-	-	-	F37	0
0447	01BF		ANALOG SELECT A STATUS	0 or 1	-	-	-	F38	0
0448	01C0		ANALOG SELECT B STATUS	0 or 1	-	-	-	F38	0
0449	01C1		ANALOG SELECT C STATUS	0 or 1	-	-	-	F38	0
0450	01C2		ANALOG SELECT D STATUS	0 or 1	-	-	-	F38	0
0451	01C3		ACCESS JUMPER STATUS	0 or 1	-	-	-	F20	1
0452	01C4		REMOTE/LOCAL 43 STATUS	0 or 1	-	-	-	F39	0
0453	01C5		RESERVED						
:	:		:						
0454	01C6		RESERVED						
0455	01C7	(575 Only)	RECLOSE ENABLE STATUS	0 or 1	-	-	-	F37	0
0456	01C8	(575 Only)	RECLOSE DISABLE STATUS	0 or 1	-	-	-	F37	1
0457	01C9		RESERVED						
:	:		:						
0459	01CB		RESERVED						
0460	01CC		LCD DISPLAY CONTRAST	0 - 10	1	-	1.00	F14	5
0461	01CD		SOFTWARE RELEASE DATE					F13	Mar 12, 1996
0463	01CF		RESERVED						
0464	01D0	FACTORY SERVICE	ANALOG OUTPUT FORCED TO	0 - 255	1	-	1.00	F14	0
0465	01D1		RESERVED						
0466	01D2		TEST LCD DISPLAY? (RESERVED)						
0467	01D3		RESERVED						
0468	01D4		LOAD FACTORY SETTINGS (RESERVED)						
0469	01D5		CAL. ANALOG IN AT 4 mA (RESERVED)						
0470	01D6		CAL. ANALOG IN AT 20 mA (RESERVED)						
0471	01D7		SEE SETPOINTS CALIBRATION MODE GROUP						
:	:		:						
0474	01DA		SEE SETPOINTS CALIBRATION MODE GROUP						
0475	01DB		RESERVED						
:	:		:						
0489	01E9		RESERVED						
0490	01EA	VOLTAGE	VT CONNECTION	0 - 3	-	-	-	F40	1
0491	01EB		VT NOMINAL SEC VOLTS	48.0 - 240.0	0.1	VOLTS	0.10	F14	120.0
0492	01EC		VT PRIMARY VOLTS	0.10 - 138.00	0.01	kV	0.01	F14	1.20
0615	0267		ZERO VOLTS DETECT	0 or 1	-	-	-	F20	1
0493	01ED		UNDERVOLT TRIP	0 or 1	-	-	-	F20	1
0494	01EE		UNDERVOLT TRIP LEVEL	50 - 100	1	%VT	1.00	F14	80
0495	01EF		UNDERVOLT TRIP DELAY	0.1 - 25.5	0.1	SEC	0.10	F14	1.0
0496	01F0		UNDERVOLT TRIP RELAY	0 - 6	-	-	-	F22	3 (565), 1 (575)
0497	01F1		UNDERVOLT ALARM	0 or 1	-	-	-	F20	1
0498	01F2		UNDERVOLT ALARM LEVEL	50 - 100	1	%VT	1.00	F14	85
0499	01F3		UNDERVOLT ALARM DELAY	0.1 - 25.5	0.1	SEC	0.10	F14	1.0
0500	01F4		UNDERVOLT ALARM RELAY	0 - 3	-	-	-	F23	1 (565), 2 (575)
0501	01F5		OVERVOLT TRIP	0 or 1	-	-	-	F20	1
0502	01F6		OVERVOLT TRIP LEVEL	101 - 125	1	%VT	1.00	F14	120
0503	01F7		OVERVOLT TRIP DELAY	0.1 - 25.5	0.1	SEC	0.10	F14	1.0
0504	01F8		OVERVOLT TRIP RELAY	0 - 6	-	-	-	F22	0 (565), 1 (575)
0505	01F9		OVERVOLT ALARM	0 or 1	-	-	-	F20	1
0506	01FA		OVERVOLT ALARM LEVEL	101 - 125	1	%VT	1.00	F14	115
0507	01FB		OVERVOLT ALARM DELAY	0.1 - 25.5	0.1	SEC	0.10	F14	1.0
0508	01FC		OVERVOLT ALARM RELAY	0 - 3	-	-	-	F23	0
0509	01FD		RESERVED						
:	:		:						
0519	0207		RESERVED						
0520	0208	DEMAND METERING	AMPS DEMAND	0 or 1	-	-	-	F20	0
0521	0209		AMPS DEMAND TIME PERIOD	5 - 120	1	MIN	1.00	F14	5
0522	020A		AMPS DEMAND ALARM	0 or 1	-	-	-	F20	1
0523	020B		AMP DEMAND ALARM LEVEL	10 - 5000	5	AMPS	1.00	F14	100
0524	020C		AMP DEMAND ALARM RELAY	0 - 3	-	-	-	F23	0 (565), 2 (575)
0525	020D		KW DEMAND	0 or 1	-	-	-	F20	0
0526	020E		KW DEMAND TIME PERIOD	5 - 120	1	MIN	1.00	F14	5
0527	020F		KW DEMAND ALARM	0 or 1	-	-	-	F20	1
0528	0210		KW DEMAND ALARM LEVEL	100 - 65000	100	kW	1.00	F14	1000
0529	0211		KW DEMAND ALARM RELAY	0 - 3	-	-	-	F23	0 (565), 2 (575)
0530	0212		KVAR DEMAND	0 or 1	-	-	-	F20	0

565/575 MEMORY MAP (REVISION E2.73)									
ADDRESS (DEC)	ADDRESS (HEX)	GROUP	DESCRIPTION	RANGE	STEP	UNITS	SCALE	FORMAT CODE	FACTORY DEFAULT
Actual Values - READ ONLY									
0531	0213		KVAR DEMAND TIME PERIOD	5 - 120	1	MIN	1.00	F14	5
0532	0214		KVAR DEMAND ALARM	0 or 1	-	-	-	F20	1
0533	0215		KVAR DEMAND AL'M LEVEL	100 - 65000	100	KVAR	1.00	F14	1000
0534	0216		KVAR DEMAND AL'M RELAY	0 - 3	-	-	-	F23	0 (565), 2 (575)
0535	0217		RESERVED						
:	:		:						
0545	0221		RESERVED						
0546	0222	MTM METERING	MTM COMM. ALARM	0 or 1	-	-	-	F20	1
0547	0223		MTM COMM. ALARM RELAY	0 - 3	-	-	-	F23	1 (565), 2 (575)
0548	0224		MTM CT SELECT	0 or 1	-	-	-	F41	0
0549	0225		MTM CT RATING PRIMARY	5 - 5000	5	AMPS	1.00	F14	100
0550	0226		POWER FACTOR ALARM	0 or 1	-	-	-	F20	1
0551	0227		P/F LEADING ALARM LEVEL	0.00 - 1.00	0.05	-	0.01	F14	0.75
0552	0228		P/F LAGGING ALARM LEVEL	0.00 - 1.00	0.05	-	0.01	F14	0.75
0553	0229		P/F ALARM DELAY	1.0 - 127.0	0.5	SEC	0.10	F14	5.0
0554	022A		P/F ALARM RELAY	0 - 3	-	-	-	F23	0 (565), 2 (575)
0555	022B		POWER FACTOR TRIP	0 or 1	-	-	-	F20	1
0556	022C		P/F LEADING TRIP LEVEL	0.00 - 1.00	0.05	-	0.01	F14	0.70
0557	022D		P/F LAGGING TRIP LEVEL	0.00 - 1.00	0.05	-	0.01	F14	0.70
0558	022E		P/F TRIP DELAY	1.0 - 127.0	0.5	SEC	0.10	F14	1.0
0559	022F		P/F TRIP RELAY	0 - 6	-	-	-	F22	1
0560	0230		FREQUENCY ALARM	0 or 1	-	-	-	F20	1
0561	0231		UNDER FREQ ALARM LEVEL	40.0 - 60.0	0.1	Hz	0.10	F14	58.0
0562	0232		OVER FREQ. ALARM LEVEL	50.0 - 72.0	0.1	Hz	0.10	F14	62.0
0563	0233		FREQUENCY ALARM DELAY	1.0 - 127.0	0.5	SEC	0.10	F14	5.0
0564	0234		FREQUENCY ALARM RELAY	0 - 3	-	-	-	F23	0 (565), 1 (575)
0565	0235		FREQUENCY TRIP	0 or 1	-	-	-	F20	1
0566	0236		UNDER FREQ. TRIP LEVEL	40.0 - 60.0	0.1	Hz	0.10	F14	56.0
0567	0237		OVER FREQ. TRIP LEVEL	50.0 - 72.0	0.1	Hz	0.10	F14	64.0
0568	0238		FREQUENCY TRIP DELAY	1.0 - 127.0	0.5	SEC	0.10	F14	1.0
0569	0239		FREQUENCY TRIP RELAY	0 - 6	-	-	-	F22	1
0570	023A		MTM SCALING FACTOR	1 - 655	1	-	1.00	F14	655
0571	023B		VOLTAGE REVERSAL TRIP	0 or 1	-	-	-	F20	1
0572	023C		VOLTAGE REVERSAL DELAY	1.0 - 127.0	0.5	SEC	0.10	F14	1.0
0573	023D		VOLTAGE REVERSAL RELAY	0 - 6	-	-	-	F22	0
0574	023E		RESERVED						
:	:		:						
0582	0246		RESERVED						
0583	0247	AUTO RECLOSURE	AUTO RECLOSURE	0 or 1	-	-	-	F20	1
0584	0248	(575 Only)	NO. OF RECLOSE SHOTS	1 - 4	1	-	1.00	F14	4
0585	0249	(575 Only)	SHOT 1 DEAD TIME	0.3 - 300.0	0.1	SEC	0.10	F14	2.0
0586	024A	(575 Only)	SHOT 2 DEAD TIME	0.3 - 300.0	0.1	SEC	0.10	F14	4.0
0587	024B	(575 Only)	SHOT 3 DEAD TIME	0.3 - 300.0	0.1	SEC	0.10	F14	6.0
0588	024C	(575 Only)	SHOT 4 DEAD TIME	0.3 - 300.0	0.1	SEC	0.10	F14	8.0
0589	024D	(575 Only)	SCHEME RESET TIME	1 - 255	1	SEC	1.00	F14	5
0590	024E	(575 Only)	RECLOSURE ENABLE RELAY	0 - 3	-	-	-	F23	2
0591	024F		RESERVED						
:	:		:						
0599	0257		RESERVED						
0600	0258	PHASE CURVES	PHASE CURVE CHANGE	0 or 1	-	-	-	F20	1
0601	0259	(575 Only)	SWITCH TO CURVE2 AFTER RECL. #	1 - 4	1	-	1.00	F14	1
0602	025A	(575 Only)	PH. O/C CURVE 2 SHAPE	0 - 7	-	-	-	F21	3
0603	025B	(575 Only)	PHASE O/C TIME DIAL 2	1 - 32	1	-	1.00	F14	1
0604	025C	(575 Only)	TRIP TIME2 (SEC) (RESERVED)						
0610	0262	GROUND CURVES	GROUND CURVE CHANGE	0 or 1	-	-	-	F20	1
0611	0263	(575 Only)	SWITCH TO CURVE2 AFTER RECL. #	1 - 4	1	-	1.00	F14	1
0612	0264	(575 Only)	GND O/C CURVE 2 SHAPE	0 - 7	-	-	-	F21	3
0613	0265	(575 Only)	GROUND O/C TIME DIAL 2	1 - 32	1	-	1.00	F14	1
0614	0266	(575 Only)	TRIP TIME2 (SEC) (RESERVED)						
0615	0267		SEE SETPOINTS VOLTAGE GROUP						
0616	0268		RESERVED						
:	:		:						
0999	03E7		RESERVED						
1000	03E8	CUSTOM PHASE CURVE 1	1.03 x PU =	0.1 - 1092.2	0.1	SEC	0.10	F14	1.0
1001	03E9		1.1 x PU =	0.1 - 1092.2	0.1	SEC	0.10	F14	1.0
1002	03EA		1.2 x PU =	0.1 - 1092.2	0.1	SEC	0.10	F14	1.0
1003	03EB		1.3 x PU =	0.1 - 1092.2	0.1	SEC	0.10	F14	1.0
1004	03EC		1.4 x PU =	0.1 - 1092.2	0.1	SEC	0.10	F14	1.0
1005	03ED		1.5 x PU =	0.1 - 1092.2	0.1	SEC	0.10	F14	1.0
1006	03EE		1.6 x PU =	0.1 - 1092.2	0.1	SEC	0.10	F14	1.0
1007	03EF		1.7 x PU =	0.1 - 1092.2	0.1	SEC	0.10	F14	1.0
1008	03F0		1.8 x PU =	0.1 - 1092.2	0.1	SEC	0.10	F14	1.0

565/575 MEMORY MAP (REVISION E2.73)									
ADDRESS (DEC)	ADDRESS (HEX)	GROUP	DESCRIPTION	RANGE	STEP	UNITS	SCALE	FORMAT CODE	FACTORY DEFAULT
Actual Values - READ ONLY									
1009	03F1		1.9 x PU =	0.1 - 1092.2	0.1	SEC	0.10	F14	1.0
1010	03F2		2.0 x PU =	0.1 - 1092.2	0.1	SEC	0.10	F14	1.0
1011	03F3		2.1 x PU =	0.1 - 1092.2	0.1	SEC	0.10	F14	1.0
1012	03F4		2.2 x PU =	0.1 - 1092.2	0.1	SEC	0.10	F14	1.0
1013	03F5		2.3 x PU =	0.1 - 1092.2	0.1	SEC	0.10	F14	1.0
1014	03F6		2.4 x PU =	0.1 - 1092.2	0.1	SEC	0.10	F14	1.0
1015	03F7		2.5 x PU =	0.1 - 1092.2	0.1	SEC	0.10	F14	1.0
1016	03F8		2.6 x PU =	0.1 - 1092.2	0.1	SEC	0.10	F14	1.0
1017	03F9		2.7 x PU =	0.1 - 1092.2	0.1	SEC	0.10	F14	1.0
1018	03FA		2.8 x PU =	0.1 - 1092.2	0.1	SEC	0.10	F14	1.0
1019	03FB		2.9 x PU =	0.1 - 1092.2	0.1	SEC	0.10	F14	1.0
1020	03FC		3.0 x PU =	0.1 - 1092.2	0.1	SEC	0.10	F14	1.0
1021	03FD		3.1 x PU =	0.1 - 1092.2	0.1	SEC	0.10	F14	1.0
1022	03FE		3.2 x PU =	0.1 - 1092.2	0.1	SEC	0.10	F14	1.0
1023	03FF		3.3 x PU =	0.1 - 1092.2	0.1	SEC	0.10	F14	1.0
1024	0400		3.4 x PU =	0.1 - 1092.2	0.1	SEC	0.10	F14	1.0
1025	0401		3.5 x PU =	0.1 - 1092.2	0.1	SEC	0.10	F14	1.0
1026	0402		3.6 x PU =	0.1 - 1092.2	0.1	SEC	0.10	F14	1.0
1027	0403		3.7 x PU =	0.1 - 1092.2	0.1	SEC	0.10	F14	1.0
1028	0404		3.8 x PU =	0.1 - 1092.2	0.1	SEC	0.10	F14	1.0
1029	0405		3.9 x PU =	0.1 - 1092.2	0.1	SEC	0.10	F14	1.0
1030	0406		4.0 x PU =	0.1 - 1092.2	0.1	SEC	0.10	F14	1.0
1031	0407		4.1 x PU =	0.1 - 1092.2	0.1	SEC	0.10	F14	1.0
1032	0408		4.2 x PU =	0.1 - 1092.2	0.1	SEC	0.10	F14	1.0
1033	0409		4.3 x PU =	0.1 - 1092.2	0.1	SEC	0.10	F14	1.0
1034	040A		4.4 x PU =	0.1 - 1092.2	0.1	SEC	0.10	F14	1.0
1035	040B		4.5 x PU =	0.1 - 1092.2	0.1	SEC	0.10	F14	1.0
1036	040C		4.6 x PU =	0.1 - 1092.2	0.1	SEC	0.10	F14	1.0
1037	040D		4.7 x PU =	0.1 - 1092.2	0.1	SEC	0.10	F14	1.0
1038	040E		4.8 x PU =	0.1 - 1092.2	0.1	SEC	0.10	F14	1.0
1039	040F		4.9 x PU =	0.1 - 1092.2	0.1	SEC	0.10	F14	1.0
1040	0410		5.0 x PU =	0.1 - 1092.2	0.1	SEC	0.10	F14	1.0
1041	0411		5.1 x PU =	0.1 - 1092.2	0.1	SEC	0.10	F14	1.0
1042	0412		5.2 x PU =	0.1 - 1092.2	0.1	SEC	0.10	F14	1.0
1043	0413		5.3 x PU =	0.1 - 1092.2	0.1	SEC	0.10	F14	1.0
1044	0414		5.4 x PU =	0.1 - 1092.2	0.1	SEC	0.10	F14	1.0
1045	0415		5.5 x PU =	0.1 - 1092.2	0.1	SEC	0.10	F14	1.0
1046	0416		5.6 x PU =	0.1 - 1092.2	0.1	SEC	0.10	F14	1.0
1047	0417		5.7 x PU =	0.1 - 1092.2	0.1	SEC	0.10	F14	1.0
1048	0418		5.8 x PU =	0.1 - 1092.2	0.1	SEC	0.10	F14	1.0
1049	0419		5.9 x PU =	0.1 - 1092.2	0.1	SEC	0.10	F14	1.0
1050	041A		6.0 x PU =	0.1 - 1092.2	0.1	SEC	0.10	F14	1.0
1051	041B		6.5 x PU =	0.1 - 1092.2	0.1	SEC	0.10	F14	1.0
1052	041C		7.0 x PU =	0.1 - 1092.2	0.1	SEC	0.10	F14	1.0
1053	041D		7.5 x PU =	0.1 - 1092.2	0.1	SEC	0.10	F14	1.0
1054	041E		8.0 x PU =	0.1 - 1092.2	0.1	SEC	0.10	F14	1.0
1055	041F		8.5 x PU =	0.1 - 1092.2	0.1	SEC	0.10	F14	1.0
1056	0420		9.0 x PU =	0.1 - 1092.2	0.1	SEC	0.10	F14	1.0
1057	0421		9.5 x PU =	0.1 - 1092.2	0.1	SEC	0.10	F14	1.0
1058	0422		10.0 x PU =	0.1 - 1092.2	0.1	SEC	0.10	F14	1.0
1059	0423		10.5 x PU =	0.1 - 1092.2	0.1	SEC	0.10	F14	1.0
1060	0424		11.0 x PU =	0.1 - 1092.2	0.1	SEC	0.10	F14	1.0
1061	0425		11.5 x PU =	0.1 - 1092.2	0.1	SEC	0.10	F14	1.0
1062	0426		12.0 x PU =	0.1 - 1092.2	0.1	SEC	0.10	F14	1.0
1063	0427		12.5 x PU =	0.1 - 1092.2	0.1	SEC	0.10	F14	1.0
1064	0428		13.0 x PU =	0.1 - 1092.2	0.1	SEC	0.10	F14	1.0
1065	0429		13.5 x PU =	0.1 - 1092.2	0.1	SEC	0.10	F14	1.0
1066	042A		14.0 x PU =	0.1 - 1092.2	0.1	SEC	0.10	F14	1.0
1067	042B		14.5 x PU =	0.1 - 1092.2	0.1	SEC	0.10	F14	1.0
1068	042C		15.0 x PU =	0.1 - 1092.2	0.1	SEC	0.10	F14	1.0
1069	042D		15.5 x PU =	0.1 - 1092.2	0.1	SEC	0.10	F14	1.0
1070	042E		16.0 x PU =	0.1 - 1092.2	0.1	SEC	0.10	F14	1.0
1071	042F		16.5 x PU =	0.1 - 1092.2	0.1	SEC	0.10	F14	1.0
1072	0430		17.0 x PU =	0.1 - 1092.2	0.1	SEC	0.10	F14	1.0
1073	0431		17.5 x PU =	0.1 - 1092.2	0.1	SEC	0.10	F14	1.0
1074	0432		18.0 x PU =	0.1 - 1092.2	0.1	SEC	0.10	F14	1.0
1075	0433		18.5 x PU =	0.1 - 1092.2	0.1	SEC	0.10	F14	1.0
1076	0434		19.0 x PU =	0.1 - 1092.2	0.1	SEC	0.10	F14	1.0
1077	0435		19.5 x PU =	0.1 - 1092.2	0.1	SEC	0.10	F14	1.0
1078	0436		20.0 x PU =	0.1 - 1092.2	0.1	SEC	0.10	F14	1.0
1079	0437		RESERVED						

565/575 MEMORY MAP (REVISION E2.73)									
ADDRESS (DEC)	ADDRESS (HEX)	GROUP	DESCRIPTION	RANGE	STEP	UNITS	SCALE	FORMAT CODE	FACTORY DEFAULT
Actual Values - READ ONLY									
1099	044B		RESERVED						
1100	044C	CUSTOM GROUND CURVE 1	1.03 x PU =	0.1 - 1092.2	0.1	SEC	0.10	F14	1.0
1101	044D		1.1 x PU =	0.1 - 1092.2	0.1	SEC	0.10	F14	1.0
1102	044E		1.2 x PU =	0.1 - 1092.2	0.1	SEC	0.10	F14	1.0
1103	044F		1.3 x PU =	0.1 - 1092.2	0.1	SEC	0.10	F14	1.0
1104	0450		1.4 x PU =	0.1 - 1092.2	0.1	SEC	0.10	F14	1.0
1105	0451		1.5 x PU =	0.1 - 1092.2	0.1	SEC	0.10	F14	1.0
1106	0452		1.6 x PU =	0.1 - 1092.2	0.1	SEC	0.10	F14	1.0
1107	0453		1.7 x PU =	0.1 - 1092.2	0.1	SEC	0.10	F14	1.0
1108	0454		1.8 x PU =	0.1 - 1092.2	0.1	SEC	0.10	F14	1.0
1109	0455		1.9 x PU =	0.1 - 1092.2	0.1	SEC	0.10	F14	1.0
1110	0456		2.0 x PU =	0.1 - 1092.2	0.1	SEC	0.10	F14	1.0
1111	0457		2.1 x PU =	0.1 - 1092.2	0.1	SEC	0.10	F14	1.0
1112	0458		2.2 x PU =	0.1 - 1092.2	0.1	SEC	0.10	F14	1.0
1113	0459		2.3 x PU =	0.1 - 1092.2	0.1	SEC	0.10	F14	1.0
1114	045A		2.4 x PU =	0.1 - 1092.2	0.1	SEC	0.10	F14	1.0
1115	045B		2.5 x PU =	0.1 - 1092.2	0.1	SEC	0.10	F14	1.0
1116	045C		2.6 x PU =	0.1 - 1092.2	0.1	SEC	0.10	F14	1.0
1117	045D		2.7 x PU =	0.1 - 1092.2	0.1	SEC	0.10	F14	1.0
1118	045E		2.8 x PU =	0.1 - 1092.2	0.1	SEC	0.10	F14	1.0
1119	045F		2.9 x PU =	0.1 - 1092.2	0.1	SEC	0.10	F14	1.0
1120	0460	3.0 x PU =	0.1 - 1092.2	0.1	SEC	0.10	F14	1.0	
1121	0461	3.1 x PU =	0.1 - 1092.2	0.1	SEC	0.10	F14	1.0	
1122	0462	3.2 x PU =	0.1 - 1092.2	0.1	SEC	0.10	F14	1.0	
1123	0463	3.3 x PU =	0.1 - 1092.2	0.1	SEC	0.10	F14	1.0	
1124	0464	3.4 x PU =	0.1 - 1092.2	0.1	SEC	0.10	F14	1.0	
1125	0465	3.5 x PU =	0.1 - 1092.2	0.1	SEC	0.10	F14	1.0	
1126	0466	3.6 x PU =	0.1 - 1092.2	0.1	SEC	0.10	F14	1.0	
1127	0467	3.7 x PU =	0.1 - 1092.2	0.1	SEC	0.10	F14	1.0	
1128	0468	3.8 x PU =	0.1 - 1092.2	0.1	SEC	0.10	F14	1.0	
1129	0469	3.9 x PU =	0.1 - 1092.2	0.1	SEC	0.10	F14	1.0	
1130	046A	4.0 x PU =	0.1 - 1092.2	0.1	SEC	0.10	F14	1.0	
1131	046B	4.1 x PU =	0.1 - 1092.2	0.1	SEC	0.10	F14	1.0	
1132	046C	4.2 x PU =	0.1 - 1092.2	0.1	SEC	0.10	F14	1.0	
1133	046D	4.3 x PU =	0.1 - 1092.2	0.1	SEC	0.10	F14	1.0	
1134	046E	4.4 x PU =	0.1 - 1092.2	0.1	SEC	0.10	F14	1.0	
1135	046F	4.5 x PU =	0.1 - 1092.2	0.1	SEC	0.10	F14	1.0	
1136	0470	4.6 x PU =	0.1 - 1092.2	0.1	SEC	0.10	F14	1.0	
1137	0471	4.7 x PU =	0.1 - 1092.2	0.1	SEC	0.10	F14	1.0	
1138	0472	4.8 x PU =	0.1 - 1092.2	0.1	SEC	0.10	F14	1.0	
1139	0473	4.9 x PU =	0.1 - 1092.2	0.1	SEC	0.10	F14	1.0	
1140	0474	5.0 x PU =	0.1 - 1092.2	0.1	SEC	0.10	F14	1.0	
1141	0475	5.1 x PU =	0.1 - 1092.2	0.1	SEC	0.10	F14	1.0	
1142	0476	5.2 x PU =	0.1 - 1092.2	0.1	SEC	0.10	F14	1.0	
1143	0477	5.3 x PU =	0.1 - 1092.2	0.1	SEC	0.10	F14	1.0	
1144	0478	5.4 x PU =	0.1 - 1092.2	0.1	SEC	0.10	F14	1.0	
1145	0479	5.5 x PU =	0.1 - 1092.2	0.1	SEC	0.10	F14	1.0	
1146	047A	5.6 x PU =	0.1 - 1092.2	0.1	SEC	0.10	F14	1.0	
1147	047B	5.7 x PU =	0.1 - 1092.2	0.1	SEC	0.10	F14	1.0	
1148	047C	5.8 x PU =	0.1 - 1092.2	0.1	SEC	0.10	F14	1.0	
1149	047D	5.9 x PU =	0.1 - 1092.2	0.1	SEC	0.10	F14	1.0	
1150	047E	6.0 x PU =	0.1 - 1092.2	0.1	SEC	0.10	F14	1.0	
1151	047F	6.5 x PU =	0.1 - 1092.2	0.1	SEC	0.10	F14	1.0	
1152	0480	7.0 x PU =	0.1 - 1092.2	0.1	SEC	0.10	F14	1.0	
1153	0481	7.5 x PU =	0.1 - 1092.2	0.1	SEC	0.10	F14	1.0	
1154	0482	8.0 x PU =	0.1 - 1092.2	0.1	SEC	0.10	F14	1.0	
1155	0483	8.5 x PU =	0.1 - 1092.2	0.1	SEC	0.10	F14	1.0	
1156	0484	9.0 x PU =	0.1 - 1092.2	0.1	SEC	0.10	F14	1.0	
1157	0485	9.5 x PU =	0.1 - 1092.2	0.1	SEC	0.10	F14	1.0	
1158	0486	10.0 x PU =	0.1 - 1092.2	0.1	SEC	0.10	F14	1.0	
1159	0487	10.5 x PU =	0.1 - 1092.2	0.1	SEC	0.10	F14	1.0	
1160	0488	11.0 x PU =	0.1 - 1092.2	0.1	SEC	0.10	F14	1.0	
1161	0489	11.5 x PU =	0.1 - 1092.2	0.1	SEC	0.10	F14	1.0	
1162	048A	12.0 x PU =	0.1 - 1092.2	0.1	SEC	0.10	F14	1.0	
1163	048B	12.5 x PU =	0.1 - 1092.2	0.1	SEC	0.10	F14	1.0	
1164	048C	13.0 x PU =	0.1 - 1092.2	0.1	SEC	0.10	F14	1.0	
1165	048D	13.5 x PU =	0.1 - 1092.2	0.1	SEC	0.10	F14	1.0	
1166	048E	14.0 x PU =	0.1 - 1092.2	0.1	SEC	0.10	F14	1.0	
1167	048F	14.5 x PU =	0.1 - 1092.2	0.1	SEC	0.10	F14	1.0	
1168	0490	15.0 x PU =	0.1 - 1092.2	0.1	SEC	0.10	F14	1.0	
1169	0491	15.5 x PU =	0.1 - 1092.2	0.1	SEC	0.10	F14	1.0	
1170	0492	16.0 x PU =	0.1 - 1092.2	0.1	SEC	0.10	F14	1.0	

565/575 MEMORY MAP (REVISION E2.73)									
ADDRESS (DEC)	ADDRESS (HEX)	GROUP	DESCRIPTION	RANGE	STEP	UNITS	SCALE	FORMAT CODE	FACTORY DEFAULT
Actual Values - READ ONLY									
1171	0493		16.5 x PU =	0.1 - 1092.2	0.1	SEC	0.10	F14	1.0
1172	0494		17.0 x PU =	0.1 - 1092.2	0.1	SEC	0.10	F14	1.0
1173	0495		17.5 x PU =	0.1 - 1092.2	0.1	SEC	0.10	F14	1.0
1174	0496		18.0 x PU =	0.1 - 1092.2	0.1	SEC	0.10	F14	1.0
1175	0497		18.5 x PU =	0.1 - 1092.2	0.1	SEC	0.10	F14	1.0
1176	0498		19.0 x PU =	0.1 - 1092.2	0.1	SEC	0.10	F14	1.0
1177	0499		19.5 x PU =	0.1 - 1092.2	0.1	SEC	0.10	F14	1.0
1178	049A		20.0 x PU =	0.1 - 1092.2	0.1	SEC	0.10	F14	1.0
1179	049B		RESERVED						
:	:		:						
1199	04AF		RESERVED						
1200	04B0	CUSTOM PHASE	1.03 x PU =	0.1 - 1092.2	0.1	SEC	0.10	F14	1.0
1201	04B1	CURVE 2	1.1 x PU =	0.1 - 1092.2	0.1	SEC	0.10	F14	1.0
1202	04B2	(575 Only)	1.2 x PU =	0.1 - 1092.2	0.1	SEC	0.10	F14	1.0
1203	04B3	(575 Only)	1.3 x PU =	0.1 - 1092.2	0.1	SEC	0.10	F14	1.0
1204	04B4	(575 Only)	1.4 x PU =	0.1 - 1092.2	0.1	SEC	0.10	F14	1.0
1205	04B5	(575 Only)	1.5 x PU =	0.1 - 1092.2	0.1	SEC	0.10	F14	1.0
1206	04B6	(575 Only)	1.6 x PU =	0.1 - 1092.2	0.1	SEC	0.10	F14	1.0
1207	04B7	(575 Only)	1.7 x PU =	0.1 - 1092.2	0.1	SEC	0.10	F14	1.0
1208	04B8	(575 Only)	1.8 x PU =	0.1 - 1092.2	0.1	SEC	0.10	F14	1.0
1209	04B9	(575 Only)	1.9 x PU =	0.1 - 1092.2	0.1	SEC	0.10	F14	1.0
1210	04BA	(575 Only)	2.0 x PU =	0.1 - 1092.2	0.1	SEC	0.10	F14	1.0
1211	04BB	(575 Only)	2.1 x PU =	0.1 - 1092.2	0.1	SEC	0.10	F14	1.0
1212	04BC	(575 Only)	2.2 x PU =	0.1 - 1092.2	0.1	SEC	0.10	F14	1.0
1213	04BD	(575 Only)	2.3 x PU =	0.1 - 1092.2	0.1	SEC	0.10	F14	1.0
1214	04BE	(575 Only)	2.4 x PU =	0.1 - 1092.2	0.1	SEC	0.10	F14	1.0
1215	04BF	(575 Only)	2.5 x PU =	0.1 - 1092.2	0.1	SEC	0.10	F14	1.0
1216	04C0	(575 Only)	2.6 x PU =	0.1 - 1092.2	0.1	SEC	0.10	F14	1.0
1217	04C1	(575 Only)	2.7 x PU =	0.1 - 1092.2	0.1	SEC	0.10	F14	1.0
1218	04C2	(575 Only)	2.8 x PU =	0.1 - 1092.2	0.1	SEC	0.10	F14	1.0
1219	04C3	(575 Only)	2.9 x PU =	0.1 - 1092.2	0.1	SEC	0.10	F14	1.0
1220	04C4	(575 Only)	3.0 x PU =	0.1 - 1092.2	0.1	SEC	0.10	F14	1.0
1221	04C5	(575 Only)	3.1 x PU =	0.1 - 1092.2	0.1	SEC	0.10	F14	1.0
1222	04C6	(575 Only)	3.2 x PU =	0.1 - 1092.2	0.1	SEC	0.10	F14	1.0
1223	04C7	(575 Only)	3.3 x PU =	0.1 - 1092.2	0.1	SEC	0.10	F14	1.0
1224	04C8	(575 Only)	3.4 x PU =	0.1 - 1092.2	0.1	SEC	0.10	F14	1.0
1225	04C9	(575 Only)	3.5 x PU =	0.1 - 1092.2	0.1	SEC	0.10	F14	1.0
1226	04CA	(575 Only)	3.6 x PU =	0.1 - 1092.2	0.1	SEC	0.10	F14	1.0
1227	04CB	(575 Only)	3.7 x PU =	0.1 - 1092.2	0.1	SEC	0.10	F14	1.0
1228	04CC	(575 Only)	3.8 x PU =	0.1 - 1092.2	0.1	SEC	0.10	F14	1.0
1229	04CD	(575 Only)	3.9 x PU =	0.1 - 1092.2	0.1	SEC	0.10	F14	1.0
1230	04CE	(575 Only)	4.0 x PU =	0.1 - 1092.2	0.1	SEC	0.10	F14	1.0
1231	04CF	(575 Only)	4.1 x PU =	0.1 - 1092.2	0.1	SEC	0.10	F14	1.0
1232	04D0	(575 Only)	4.2 x PU =	0.1 - 1092.2	0.1	SEC	0.10	F14	1.0
1233	04D1	(575 Only)	4.3 x PU =	0.1 - 1092.2	0.1	SEC	0.10	F14	1.0
1234	04D2	(575 Only)	4.4 x PU =	0.1 - 1092.2	0.1	SEC	0.10	F14	1.0
1235	04D3	(575 Only)	4.5 x PU =	0.1 - 1092.2	0.1	SEC	0.10	F14	1.0
1236	04D4	(575 Only)	4.6 x PU =	0.1 - 1092.2	0.1	SEC	0.10	F14	1.0
1237	04D5	(575 Only)	4.7 x PU =	0.1 - 1092.2	0.1	SEC	0.10	F14	1.0
1238	04D6	(575 Only)	4.8 x PU =	0.1 - 1092.2	0.1	SEC	0.10	F14	1.0
1239	04D7	(575 Only)	4.9 x PU =	0.1 - 1092.2	0.1	SEC	0.10	F14	1.0
1240	04D8	(575 Only)	5.0 x PU =	0.1 - 1092.2	0.1	SEC	0.10	F14	1.0
1241	04D9	(575 Only)	5.1 x PU =	0.1 - 1092.2	0.1	SEC	0.10	F14	1.0
1242	04DA	(575 Only)	5.2 x PU =	0.1 - 1092.2	0.1	SEC	0.10	F14	1.0
1243	04DB	(575 Only)	5.3 x PU =	0.1 - 1092.2	0.1	SEC	0.10	F14	1.0
1244	04DC	(575 Only)	5.4 x PU =	0.1 - 1092.2	0.1	SEC	0.10	F14	1.0
1245	04DD	(575 Only)	5.5 x PU =	0.1 - 1092.2	0.1	SEC	0.10	F14	1.0
1246	04DE	(575 Only)	5.6 x PU =	0.1 - 1092.2	0.1	SEC	0.10	F14	1.0
1247	04DF	(575 Only)	5.7 x PU =	0.1 - 1092.2	0.1	SEC	0.10	F14	1.0
1248	04E0	(575 Only)	5.8 x PU =	0.1 - 1092.2	0.1	SEC	0.10	F14	1.0
1249	04E1	(575 Only)	5.9 x PU =	0.1 - 1092.2	0.1	SEC	0.10	F14	1.0
1250	04E2	(575 Only)	6.0 x PU =	0.1 - 1092.2	0.1	SEC	0.10	F14	1.0
1251	04E3	(575 Only)	6.5 x PU =	0.1 - 1092.2	0.1	SEC	0.10	F14	1.0
1252	04E4	(575 Only)	7.0 x PU =	0.1 - 1092.2	0.1	SEC	0.10	F14	1.0
1253	04E5	(575 Only)	7.5 x PU =	0.1 - 1092.2	0.1	SEC	0.10	F14	1.0
1254	04E6	(575 Only)	8.0 x PU =	0.1 - 1092.2	0.1	SEC	0.10	F14	1.0
1255	04E7	(575 Only)	8.5 x PU =	0.1 - 1092.2	0.1	SEC	0.10	F14	1.0
1256	04E8	(575 Only)	9.0 x PU =	0.1 - 1092.2	0.1	SEC	0.10	F14	1.0
1257	04E9	(575 Only)	9.5 x PU =	0.1 - 1092.2	0.1	SEC	0.10	F14	1.0
1258	04EA	(575 Only)	10.0 x PU =	0.1 - 1092.2	0.1	SEC	0.10	F14	1.0
1259	04EB	(575 Only)	10.5 x PU =	0.1 - 1092.2	0.1	SEC	0.10	F14	1.0
1260	04EC	(575 Only)	11.0 x PU =	0.1 - 1092.2	0.1	SEC	0.10	F14	1.0

565/575 MEMORY MAP (REVISION E2.73)									
ADDRESS (DEC)	ADDRESS (HEX)	GROUP	DESCRIPTION	RANGE	STEP	UNITS	SCALE	FORMAT CODE	FACTORY DEFAULT
Actual Values - READ ONLY									
1261	04ED	(575 Only)	11.5 x PU =	0.1 - 1092.2	0.1	SEC	0.10	F14	1.0
1262	04EE	(575 Only)	12.0 x PU =	0.1 - 1092.2	0.1	SEC	0.10	F14	1.0
1263	04EF	(575 Only)	12.5 x PU =	0.1 - 1092.2	0.1	SEC	0.10	F14	1.0
1264	04F0	(575 Only)	13.0 x PU =	0.1 - 1092.2	0.1	SEC	0.10	F14	1.0
1265	04F1	(575 Only)	13.5 x PU =	0.1 - 1092.2	0.1	SEC	0.10	F14	1.0
1266	04F2	(575 Only)	14.0 x PU =	0.1 - 1092.2	0.1	SEC	0.10	F14	1.0
1267	04F3	(575 Only)	14.5 x PU =	0.1 - 1092.2	0.1	SEC	0.10	F14	1.0
1268	04F4	(575 Only)	15.0 x PU =	0.1 - 1092.2	0.1	SEC	0.10	F14	1.0
1269	04F5	(575 Only)	15.5 x PU =	0.1 - 1092.2	0.1	SEC	0.10	F14	1.0
1270	04F6	(575 Only)	16.0 x PU =	0.1 - 1092.2	0.1	SEC	0.10	F14	1.0
1271	04F7	(575 Only)	16.5 x PU =	0.1 - 1092.2	0.1	SEC	0.10	F14	1.0
1272	04F8	(575 Only)	17.0 x PU =	0.1 - 1092.2	0.1	SEC	0.10	F14	1.0
1273	04F9	(575 Only)	17.5 x PU =	0.1 - 1092.2	0.1	SEC	0.10	F14	1.0
1274	04FA	(575 Only)	18.0 x PU =	0.1 - 1092.2	0.1	SEC	0.10	F14	1.0
1275	04FB	(575 Only)	18.5 x PU =	0.1 - 1092.2	0.1	SEC	0.10	F14	1.0
1276	04FC	(575 Only)	19.0 x PU =	0.1 - 1092.2	0.1	SEC	0.10	F14	1.0
1277	04FD	(575 Only)	19.5 x PU =	0.1 - 1092.2	0.1	SEC	0.10	F14	1.0
1278	04FE	(575 Only)	20.0 x PU =	0.1 - 1092.2	0.1	SEC	0.10	F14	1.0
1279	04FF		RESERVED						
:	:		:						
1299	0513		RESERVED						
1300	0514	CUSTOM GROUND	1.03 x PU =	0.1 - 1092.2	0.1	SEC	0.10	F14	1.0
1301	0515	CURVE 2	1.1 x PU =	0.1 - 1092.2	0.1	SEC	0.10	F14	1.0
1302	0516	(575 Only)	1.2 x PU =	0.1 - 1092.2	0.1	SEC	0.10	F14	1.0
1303	0517	(575 Only)	1.3 x PU =	0.1 - 1092.2	0.1	SEC	0.10	F14	1.0
1304	0518	(575 Only)	1.4 x PU =	0.1 - 1092.2	0.1	SEC	0.10	F14	1.0
1305	0519	(575 Only)	1.5 x PU =	0.1 - 1092.2	0.1	SEC	0.10	F14	1.0
1306	051A	(575 Only)	1.6 x PU =	0.1 - 1092.2	0.1	SEC	0.10	F14	1.0
1307	051B	(575 Only)	1.7 x PU =	0.1 - 1092.2	0.1	SEC	0.10	F14	1.0
1308	051C	(575 Only)	1.8 x PU =	0.1 - 1092.2	0.1	SEC	0.10	F14	1.0
1309	051D	(575 Only)	1.9 x PU =	0.1 - 1092.2	0.1	SEC	0.10	F14	1.0
1310	051E	(575 Only)	2.0 x PU =	0.1 - 1092.2	0.1	SEC	0.10	F14	1.0
1311	051F	(575 Only)	2.1 x PU =	0.1 - 1092.2	0.1	SEC	0.10	F14	1.0
1312	0520	(575 Only)	2.2 x PU =	0.1 - 1092.2	0.1	SEC	0.10	F14	1.0
1313	0521	(575 Only)	2.3 x PU =	0.1 - 1092.2	0.1	SEC	0.10	F14	1.0
1314	0522	(575 Only)	2.4 x PU =	0.1 - 1092.2	0.1	SEC	0.10	F14	1.0
1315	0523	(575 Only)	2.5 x PU =	0.1 - 1092.2	0.1	SEC	0.10	F14	1.0
1316	0524	(575 Only)	2.6 x PU =	0.1 - 1092.2	0.1	SEC	0.10	F14	1.0
1317	0525	(575 Only)	2.7 x PU =	0.1 - 1092.2	0.1	SEC	0.10	F14	1.0
1318	0526	(575 Only)	2.8 x PU =	0.1 - 1092.2	0.1	SEC	0.10	F14	1.0
1319	0527	(575 Only)	2.9 x PU =	0.1 - 1092.2	0.1	SEC	0.10	F14	1.0
1320	0528	(575 Only)	3.0 x PU =	0.1 - 1092.2	0.1	SEC	0.10	F14	1.0
1321	0529	(575 Only)	3.1 x PU =	0.1 - 1092.2	0.1	SEC	0.10	F14	1.0
1322	052A	(575 Only)	3.2 x PU =	0.1 - 1092.2	0.1	SEC	0.10	F14	1.0
1323	052B	(575 Only)	3.3 x PU =	0.1 - 1092.2	0.1	SEC	0.10	F14	1.0
1324	052C	(575 Only)	3.4 x PU =	0.1 - 1092.2	0.1	SEC	0.10	F14	1.0
1325	052D	(575 Only)	3.5 x PU =	0.1 - 1092.2	0.1	SEC	0.10	F14	1.0
1326	052E	(575 Only)	3.6 x PU =	0.1 - 1092.2	0.1	SEC	0.10	F14	1.0
1327	052F	(575 Only)	3.7 x PU =	0.1 - 1092.2	0.1	SEC	0.10	F14	1.0
1328	0530	(575 Only)	3.8 x PU =	0.1 - 1092.2	0.1	SEC	0.10	F14	1.0
1329	0531	(575 Only)	3.9 x PU =	0.1 - 1092.2	0.1	SEC	0.10	F14	1.0
1330	0532	(575 Only)	4.0 x PU =	0.1 - 1092.2	0.1	SEC	0.10	F14	1.0
1331	0533	(575 Only)	4.1 x PU =	0.1 - 1092.2	0.1	SEC	0.10	F14	1.0
1332	0534	(575 Only)	4.2 x PU =	0.1 - 1092.2	0.1	SEC	0.10	F14	1.0
1333	0535	(575 Only)	4.3 x PU =	0.1 - 1092.2	0.1	SEC	0.10	F14	1.0
1334	0536	(575 Only)	4.4 x PU =	0.1 - 1092.2	0.1	SEC	0.10	F14	1.0
1335	0537	(575 Only)	4.5 x PU =	0.1 - 1092.2	0.1	SEC	0.10	F14	1.0
1336	0538	(575 Only)	4.6 x PU =	0.1 - 1092.2	0.1	SEC	0.10	F14	1.0
1337	0539	(575 Only)	4.7 x PU =	0.1 - 1092.2	0.1	SEC	0.10	F14	1.0
1338	053A	(575 Only)	4.8 x PU =	0.1 - 1092.2	0.1	SEC	0.10	F14	1.0
1339	053B	(575 Only)	4.9 x PU =	0.1 - 1092.2	0.1	SEC	0.10	F14	1.0
1340	053C	(575 Only)	5.0 x PU =	0.1 - 1092.2	0.1	SEC	0.10	F14	1.0
1341	053D	(575 Only)	5.1 x PU =	0.1 - 1092.2	0.1	SEC	0.10	F14	1.0
1342	053E	(575 Only)	5.2 x PU =	0.1 - 1092.2	0.1	SEC	0.10	F14	1.0
1343	053F	(575 Only)	5.3 x PU =	0.1 - 1092.2	0.1	SEC	0.10	F14	1.0
1344	0540	(575 Only)	5.4 x PU =	0.1 - 1092.2	0.1	SEC	0.10	F14	1.0
1345	0541	(575 Only)	5.5 x PU =	0.1 - 1092.2	0.1	SEC	0.10	F14	1.0
1346	0542	(575 Only)	5.6 x PU =	0.1 - 1092.2	0.1	SEC	0.10	F14	1.0
1347	0543	(575 Only)	5.7 x PU =	0.1 - 1092.2	0.1	SEC	0.10	F14	1.0
1348	0544	(575 Only)	5.8 x PU =	0.1 - 1092.2	0.1	SEC	0.10	F14	1.0
1349	0545	(575 Only)	5.9 x PU =	0.1 - 1092.2	0.1	SEC	0.10	F14	1.0
1350	0546	(575 Only)	6.0 x PU =	0.1 - 1092.2	0.1	SEC	0.10	F14	1.0

565/575 MEMORY MAP (REVISION E2.73)									
ADDRESS (DEC)	ADDRESS (HEX)	GROUP	DESCRIPTION	RANGE	STEP	UNITS	SCALE	FORMAT CODE	FACTORY DEFAULT
Actual Values - READ ONLY									
1351	0547	(575 Only)	6.5 x PU =	0.1 - 1092.2	0.1	SEC	0.10	F14	1.0
1352	0548	(575 Only)	7.0 x PU =	0.1 - 1092.2	0.1	SEC	0.10	F14	1.0
1353	0549	(575 Only)	7.5 x PU =	0.1 - 1092.2	0.1	SEC	0.10	F14	1.0
1354	054A	(575 Only)	8.0 x PU =	0.1 - 1092.2	0.1	SEC	0.10	F14	1.0
1355	054B	(575 Only)	8.5 x PU =	0.1 - 1092.2	0.1	SEC	0.10	F14	1.0
1356	054C	(575 Only)	9.0 x PU =	0.1 - 1092.2	0.1	SEC	0.10	F14	1.0
1357	054D	(575 Only)	9.5 x PU =	0.1 - 1092.2	0.1	SEC	0.10	F14	1.0
1358	054E	(575 Only)	10.0 x PU =	0.1 - 1092.2	0.1	SEC	0.10	F14	1.0
1359	054F	(575 Only)	10.5 x PU =	0.1 - 1092.2	0.1	SEC	0.10	F14	1.0
1360	0550	(575 Only)	11.0 x PU =	0.1 - 1092.2	0.1	SEC	0.10	F14	1.0
1361	0551	(575 Only)	11.5 x PU =	0.1 - 1092.2	0.1	SEC	0.10	F14	1.0
1362	0552	(575 Only)	12.0 x PU =	0.1 - 1092.2	0.1	SEC	0.10	F14	1.0
1363	0553	(575 Only)	12.5 x PU =	0.1 - 1092.2	0.1	SEC	0.10	F14	1.0
1364	0554	(575 Only)	13.0 x PU =	0.1 - 1092.2	0.1	SEC	0.10	F14	1.0
1365	0555	(575 Only)	13.5 x PU =	0.1 - 1092.2	0.1	SEC	0.10	F14	1.0
1366	0556	(575 Only)	14.0 x PU =	0.1 - 1092.2	0.1	SEC	0.10	F14	1.0
1367	0557	(575 Only)	14.5 x PU =	0.1 - 1092.2	0.1	SEC	0.10	F14	1.0
1368	0558	(575 Only)	15.0 x PU =	0.1 - 1092.2	0.1	SEC	0.10	F14	1.0
1369	0559	(575 Only)	15.5 x PU =	0.1 - 1092.2	0.1	SEC	0.10	F14	1.0
1370	055A	(575 Only)	16.0 x PU =	0.1 - 1092.2	0.1	SEC	0.10	F14	1.0
1371	055B	(575 Only)	16.5 x PU =	0.1 - 1092.2	0.1	SEC	0.10	F14	1.0
1372	055C	(575 Only)	17.0 x PU =	0.1 - 1092.2	0.1	SEC	0.10	F14	1.0
1373	055D	(575 Only)	17.5 x PU =	0.1 - 1092.2	0.1	SEC	0.10	F14	1.0
1374	055E	(575 Only)	18.0 x PU =	0.1 - 1092.2	0.1	SEC	0.10	F14	1.0
1375	055F	(575 Only)	18.5 x PU =	0.1 - 1092.2	0.1	SEC	0.10	F14	1.0
1376	0560	(575 Only)	19.0 x PU =	0.1 - 1092.2	0.1	SEC	0.10	F14	1.0
1377	0561	(575 Only)	19.5 x PU =	0.1 - 1092.2	0.1	SEC	0.10	F14	1.0
1378	0562	(575 Only)	20.0 x PU =	0.1 - 1092.2	0.1	SEC	0.10	F14	1.0
1379	0563		RESERVED						
:	:		:						
1535	05FF		RESERVED						
1536	0600	EVENT RECORDER	EVENT RECORD 1	-	-	-	-	F42	-
:	:		:						
1555	0613		EVENT RECORD 1	-	-	-	-	F42	-
1556	0614		EVENT RECORD 2	-	-	-	-	F42	-
:	:		:						
1575	0627		EVENT RECORD 2	-	-	-	-	F42	-
1576	0628		EVENT RECORD 3	-	-	-	-	F42	-
:	:		:						
1595	063B		EVENT RECORD 3	-	-	-	-	F42	-
1596	063C		EVENT RECORD 4	-	-	-	-	F42	-
:	:		:						
1615	064F		EVENT RECORD 4	-	-	-	-	F42	-
1616	0650		EVENT RECORD 5	-	-	-	-	F42	-
:	:		:						
1635	0663		EVENT RECORD 5	-	-	-	-	F42	-
1636	0664		EVENT RECORD 6	-	-	-	-	F42	-
:	:		:						
1655	0677		EVENT RECORD 6	-	-	-	-	F42	-
1656	0678		EVENT RECORD 7	-	-	-	-	F42	-
:	:		:						
1675	068B		EVENT RECORD 7	-	-	-	-	F42	-
1676	068C		EVENT RECORD 8	-	-	-	-	F42	-
:	:		:						
1695	069F		EVENT RECORD 8	-	-	-	-	F42	-
1696	06A0		EVENT RECORD 9	-	-	-	-	F42	-
:	:		:						
1715	06B3		EVENT RECORD 9	-	-	-	-	F42	-
1716	06B4		EVENT RECORD 10	-	-	-	-	F42	-
:	:		:						
1735	06C7		EVENT RECORD 10	-	-	-	-	F42	-
1736	06C8		EVENT RECORD 11	-	-	-	-	F42	-
:	:		:						
1755	06DB		EVENT RECORD 11	-	-	-	-	F42	-
1756	06DC		EVENT RECORD 12	-	-	-	-	F42	-
:	:		:						
1775	06EF		EVENT RECORD 12	-	-	-	-	F42	-
1776	06F0		EVENT RECORD 13	-	-	-	-	F42	-
:	:		:						
1795	0703		EVENT RECORD 13	-	-	-	-	F42	-
1796	0704		EVENT RECORD 14	-	-	-	-	F42	-
:	:		:						

565/575 MEMORY MAP (REVISION E2.73)									
ADDRESS (DEC)	ADDRESS (HEX)	GROUP	DESCRIPTION	RANGE	STEP	UNITS	SCALE	FORMAT CODE	FACTORY DEFAULT
Actual Values - READ ONLY									
1815	0717		EVENT RECORD 14	-	-	-	-	F42	-
1816	0718		EVENT RECORD 15	-	-	-	-	F42	-
:	:		:	-	-	-	-		-
1835	072B		EVENT RECORD 15	-	-	-	-	F42	-
1836	072C		EVENT RECORD 16	-	-	-	-	F42	-
:	:		:	-	-	-	-		-
1855	073F		EVENT RECORD 16	-	-	-	-	F42	-
1856	0740		EVENT RECORD 17	-	-	-	-	F42	-
:	:		:	-	-	-	-		-
1875	0753		EVENT RECORD 17	-	-	-	-	F42	-
1876	0754		EVENT RECORD 18	-	-	-	-	F42	-
:	:		:	-	-	-	-		-
1895	0767		EVENT RECORD 18	-	-	-	-	F42	-
1896	0768		EVENT RECORD 19	-	-	-	-	F42	-
:	:		:	-	-	-	-		-
1915	077B		EVENT RECORD 19	-	-	-	-	F42	-
1916	077C		EVENT RECORD 20	-	-	-	-	F42	-
:	:		:	-	-	-	-		-
1935	078F		EVENT RECORD 20	-	-	-	-	F42	-
1936	0790		EVENT RECORD 21	-	-	-	-	F42	-
:	:		:	-	-	-	-		-
1955	07A3		EVENT RECORD 21	-	-	-	-	F42	-
1956	07A4		EVENT RECORD 22	-	-	-	-	F42	-
:	:		:	-	-	-	-		-
1975	07B7		EVENT RECORD 22	-	-	-	-	F42	-
1976	07B8		EVENT RECORD 23	-	-	-	-	F42	-
:	:		:	-	-	-	-		-
1995	07CB		EVENT RECORD 23	-	-	-	-	F42	-
1996	07CC		EVENT RECORD 24	-	-	-	-	F42	-
:	:		:	-	-	-	-		-
2015	07DF		EVENT RECORD 24	-	-	-	-	F42	-
2016	07E0		EVENT RECORD 25	-	-	-	-	F42	-
:	:		:	-	-	-	-		-
2035	07F3		EVENT RECORD 25	-	-	-	-	F42	-
2036	07F4		EVENT RECORD 26	-	-	-	-	F42	-
:	:		:	-	-	-	-		-
2055	0807		EVENT RECORD 26	-	-	-	-	F42	-
2056	0808		EVENT RECORD 27	-	-	-	-	F42	-
:	:		:	-	-	-	-		-
2075	081B		EVENT RECORD 27	-	-	-	-	F42	-
2076	081C		EVENT RECORD 28	-	-	-	-	F42	-
:	:		:	-	-	-	-		-
2095	082F		EVENT RECORD 28	-	-	-	-	F42	-
2096	0830		EVENT RECORD 29	-	-	-	-	F42	-
:	:		:	-	-	-	-		-
2115	0843		EVENT RECORD 29	-	-	-	-	F42	-
2116	0844		EVENT RECORD 30	-	-	-	-	F42	-
:	:		:	-	-	-	-		-
2135	0857		EVENT RECORD 30	-	-	-	-	F42	-
2136	0858		EVENT RECORD 31	-	-	-	-	F42	-
:	:		:	-	-	-	-		-
2155	086B		EVENT RECORD 31	-	-	-	-	F42	-
2156	086C		EVENT RECORD 32	-	-	-	-	F42	-
:	:		:	-	-	-	-		-
2175	087F		EVENT RECORD 32	-	-	-	-	F42	-
2176	0880		EVENT RECORD 33	-	-	-	-	F42	-
:	:		:	-	-	-	-		-
2195	0893		EVENT RECORD 33	-	-	-	-	F42	-
2196	0894		EVENT RECORD 34	-	-	-	-	F42	-
:	:		:	-	-	-	-		-
2215	08A7		EVENT RECORD 34	-	-	-	-	F42	-
2216	08A8		EVENT RECORD 35	-	-	-	-	F42	-
:	:		:	-	-	-	-		-
2235	08BB		EVENT RECORD 35	-	-	-	-	F42	-
2236	08BC		EVENT RECORD 36	-	-	-	-	F42	-
:	:		:	-	-	-	-		-
2255	08CF		EVENT RECORD 36	-	-	-	-	F42	-
2256	08D0		EVENT RECORD 37	-	-	-	-	F42	-
:	:		:	-	-	-	-		-
2275	08E3		EVENT RECORD 37	-	-	-	-	F42	-
2276	08E4		EVENT RECORD 38	-	-	-	-	F42	-
:	:		:	-	-	-	-		-

565/575 MEMORY MAP (REVISION E2.73)									
ADDRESS (DEC) (HEX)		GROUP	DESCRIPTION	RANGE	STEP	UNITS	SCALE	FORMAT CODE	FACTORY DEFAULT
Actual Values - READ ONLY									
2295	08F7		EVENT RECORD 38	-	-	-	-	F42	-
2296	08F8		EVENT RECORD 39	-	-	-	-	F42	-
:	:		:						
2315	090B		EVENT RECORD 39	-	-	-	-	F42	-
2316	090C		EVENT RECORD 40	-	-	-	-	F42	-
:	:		:						
2335	091F		EVENT RECORD 40	-	-	-	-	F42	-

www.ElectricalPartManuals.com

565/575 DATA FORMATS (REVISION E2.73)		
FORMAT CODE	APPLICABLE BITS	DEFINITION
F1	16 bits	MULTILIN PRODUCT DEVICE CODE
	0000 0000 0001 0010 (BIN) or 0012 (HEX) 0000 0000 0011 1010 (BIN) or 003A (HEX)	18 (DEC) = 565 Feeder Management Relay 58 (DEC) = 575 Feeder Management Relay
F2	16 bits	565/575 HARDWARE REVISION
	0000 0000 0000 0000 (BIN) or 0000 (HEX)	00 (DEC) = Undefined
	0000 0000 0000 0001 (BIN) or 0001 (HEX)	01 (DEC) = A
	0000 0000 0000 0010 (BIN) or 0002 (HEX)	02 (DEC) = B
	0000 0000 0000 0011 (BIN) or 0003 (HEX)	03 (DEC) = C
	0000 0000 0000 0100 (BIN) or 0004 (HEX)	04 (DEC) = D
	0000 0000 0000 0101 (BIN) or 0005 (HEX)	05 (DEC) = E
	0000 0000 0001 1010 (BIN) or 001A (HEX)	26 (DEC) = Z
F3	16 bits	565/575 FIRMWARE REVISION
	0000 XXXX 0000 0000 (BIN) or 0X00 (HEX)	Major Revision Digits (0 through 9 only)
	0000 0000 XXXX 0000 (BIN) or 00X0 (HEX)	Minor Revision Digits (0 through 9 only)
	0000 0000 0000 XXXX (BIN) or 000X (HEX) 0000 0010 0111 0011 (BIN) or 0273 (HEX)	Ultra Minor Revision Digits (0 through 9 only) Example: Revision 2.73 Stored As 0273 (HEX)
F4	16 bits	565/575 FIRMWARE MODIFICATION
	0000 0000 0000 0000 (BIN) or 0000 (HEX) 0000 0001 0010 1011 (BIN) or 012B (HEX)	000 (DEC) = No Modification (Standard Feeder Management Relay) 299 (DEC) = Modification 299
F5	16 bits	START OF EVENT QUEUE (POINTER TO MOST RECENT EVENT)
	0000 0000 XXXX XXXX (BIN) or 00XX (HEX)	Points To Most Recent Event Record Number (0 through 39 only)
	XXXX XXXX 0000 0000 (BIN) or XX00 (HEX)	Wrap Around Counter Incremented Every 40 Events
	000 0000 0000 0000 (BIN) or 0000 (HEX)	000 (DEC) = No. Of Events Register At 74 (HEX) Points To Most Recent Event Record
	0000 0000 0000 0001 (BIN) or 0001 (HEX)	001 (DEC) = Points To Event Record 01 As The Most Recent Event
	0000 0000 0000 0010 (BIN) or 0002 (HEX)	002 (DEC) = Points To Event Record 02 As The Most Recent Event
	0000 0000 0000 0011 (BIN) or 0003 (HEX)	003 (DEC) = Points To Event Record 03 As The Most Recent Event
	:	:
	0000 0000 0010 0111 (BIN) or 0027 (HEX)	039 (DEC) = Points To Event Record 39 As The Most Recent Event
	0000 0001 0000 0000 (BIN) or 0100 (HEX) 0000 0001 0000 0001 (BIN) or 0101 (HEX)	256 (DEC) = Points To Event Record 40 As The Most Recent Event 257 (DEC) = Points To Event Record 01 As The Most Recent Event
F6	16 bits	565/575 TRIP STATUS
	0000 0000 0000 0000 (BIN) or 0000 (HEX) 0000 0000 0000 0001 (BIN) or 0001 (HEX)	0 (DEC) = 565/575 Not Tripped Since Last Reset 1 (DEC) = 565/575 Tripped Since Last Reset
F7	16 bits	BREAKER POSITION STATUS
	0000 0000 0001 0000 (BIN) or 0010 (HEX) 0000 0000 0010 0000 (BIN) or 0020 (HEX)	16 (DEC) = Breaker Open 32 (DEC) = Breaker Closed
F8	16 bits	ALARM STATUS I
	0000 0000 0000 0001 (BIN) or 0001 (HEX)	001 (DEC) = Undefined
	0000 0000 0000 0010 (BIN) or 0002 (HEX)	002 (DEC) = MTM Communication Alarm
	0000 0000 0000 0100 (BIN) or 0004 (HEX)	004 (DEC) = Switch Alarm 2
	0000 0000 0000 1000 (BIN) or 0008 (HEX)	008 (DEC) = Trip Coil Supervision Alarm
	0000 0000 0001 0000 (BIN) or 0010 (HEX)	016 (DEC) = Frequency Alarm
	0000 0000 0010 0000 (BIN) or 0020 (HEX)	032 (DEC) = Power Factor Alarm
	0000 0000 0100 0000 (BIN) or 0040 (HEX)	064 (DEC) = KVAR Demand Alarm
	0000 0000 1000 0000 (BIN) or 0080 (HEX)	128 (DEC) = KW Demand Alarm
		Note: Multiple Alarms Can Be Reported
		ALARM STATUS II
F9	16 bits	
	0000 0000 0000 0001 (BIN) or 0001 (HEX)	001 (DEC) = Amps Demand Alarm
	0000 0000 0000 0010 (BIN) or 0002 (HEX)	002 (DEC) = Accumulated KA Alarm
	0000 0000 0000 0100 (BIN) or 0004 (HEX)	004 (DEC) = Overvoltage Alarm
	0000 0000 0000 1000 (BIN) or 0008 (HEX)	008 (DEC) = Undervoltage Alarm
	0000 0000 0001 0000 (BIN) or 0010 (HEX)	016 (DEC) = Analog In Alarm
	0000 0000 0010 0000 (BIN) or 0020 (HEX)	032 (DEC) = Switch Alarm 1
	0000 0000 0100 0000 (BIN) or 0040 (HEX)	064 (DEC) = Ground Alarm
	0000 0000 1000 0000 (BIN) or 0080 (HEX)	128 (DEC) = Phase Alarm
		Note: Multiple Alarms Can Be Reported
F10	16 bits	EXTERNAL SWITCH STATUS
	0000 0000 0000 0001 (BIN) or 0001 (HEX)	001 (DEC) = External Switch 1 Active (N/O Switch Is Closed) or (N/C Switch Is Open)
	0000 0000 0000 0010 (BIN) or 0002 (HEX)	002 (DEC) = External Switch 2 Active (N/O Switch Is Closed) or (N/C Switch Is Open)
	0000 0000 0000 0100 (BIN) or 0004 (HEX)	004 (DEC) = External Switch 3 Active (N/O Switch Is Closed) or (N/C Switch Is Open)
	0000 0000 0000 1000 (BIN) or 0008 (HEX)	008 (DEC) = External Switch 4 Active (N/O Switch Is Closed) or (N/C Switch Is Open)
	0000 0000 0001 0000 (BIN) or 0010 (HEX)	016 (DEC) = External Switch 5 Active (N/O Switch Is Closed) or (N/C Switch Is Open)
	0000 0000 0010 0000 (BIN) or 0020 (HEX)	032 (DEC) = External Switch 6 Active (N/O Switch Is Closed) or (N/C Switch Is Open)
	0000 0000 0100 0000 (BIN) or 0040 (HEX)	064 (DEC) = External Switch 7 Active (N/O Switch Is Closed) or (N/C Switch Is Open)
	0000 0000 1000 0000 (BIN) or 0080 (HEX)	128 (DEC) = External Switch 8 Active (N/O Switch Is Closed) or (N/C Switch Is Open)
		Note: Multiple Switches Can Be Reported
F11	16 bits	OUTPUT CONTACT STATUS
	0000 0000 0000 0001 (BIN) or 0001 (HEX)	001 (DEC) = Aux 3 Relay Is Or Has Been Activated By A Trip Since Last Reset (*)
	0000 0000 0000 0010 (BIN) or 0002 (HEX)	002 (DEC) = Aux 2 Relay Is Or Has Been Activated By A Trip Since Last Reset (*)
	0000 0000 0000 0100 (BIN) or 0004 (HEX)	004 (DEC) = Aux 1 Relay Is Or Has Been Activated By A Trip Since Last Reset (*)
	0000 0000 0000 1000 (BIN) or 0008 (HEX)	008 (DEC) = Trip Relay Is Or Has Been Activated By A Trip Since Last Reset (*)

565/575 DATA FORMATS (REVISION E2.73)		
FORMAT CODE	APPLICABLE BITS	DEFINITION
	0000 0000 0001 0000 (BIN) or 0010 (HEX) 0000 0000 0010 0000 (BIN) or 0020 (HEX) 0000 0000 0100 0000 (BIN) or 0040 (HEX) 0000 0000 1000 0000 (BIN) or 0080 (HEX)	016 (DEC) = Aux 3 Relay Is Activated By A Trip Or An Alarm At Moment Of Request 032 (DEC) = Aux 2 Relay Is Activated By A Trip Or An Alarm At Moment Of Request 064 (DEC) = Aux 1 Relay Is Activated By A Trip Or An Alarm At Moment Of Request 128 (DEC) = Trip Relay Is Activated By A Trip At Moment Of Request (*) An Alarm Condition Will Not Activate This Bit
F12	32 bits	ULONG (4 BYTE UNSIGNED INTEGER TO BE MULTIPLIED BY SCALING FACTOR)
	XX XX 00 00 (HEX) 00 00 XX XX (HEX) XX XX XX XX (HEX) 00 03 5C 71 (HEX)	Lower Address Contains The Most Significant 16 bits Upper Address Contains The Least Significant 16 bits Example: XXXXXX (DEC) * Scaling Factor = Result 220273 (DEC) * 0.01 = 2202.73 Amps Note: This Register Should Be Read As Four Continuous Bytes Note: Only Reading The Upper Address Will Return Zero, As This Register Is Non-existent
F13	32 bits	LONG (BCD FORMAT FOR TIME AND DATE)
	XX SS MM HH (BCD) 81 48 58 07 (BCD) : XX DD MM YY (BCD) 00 18 07 95 (BCD)	Lower Address Contains Don't Care And The Seconds Upper Address Contains The Minutes And The Hour Example: 07 (Hour) : 58 (Minutes) : 48 (Seconds) Range: 00:00:00 To 23:59:59 : Lower Address Contains Don't Care And The Day Upper Address Contains The Month And The Year Example: July 18, 1995 Range: Jan 01, 1969 To Dec 31, 2068 Note: This Register Should Be Read As Four Continuous Bytes Note: Only Reading The Upper Address Will Return Zero, As This Register Is Non-existent
F14	16 bits	UNSIGNED VALUE (2 BYTE UNSIGNED INTEGER TO BE MULTIPLIED BY SCALING FACTOR)
	XXXX XXXX XXXX XXXX (BIN) or XXXX (HEX) 0000 0001 1010 0000 (BIN) or 01A0 (HEX)	Example: XXX (DEC) * Scaling Factor = Result 416 (DEC) * 0.01 = 4.16 kV
F15	32 bits	CAUSE OF LAST TRIP
	00 00 00 00 (HEX) 00 00 00 01 (HEX) 00 00 00 02 (HEX) 00 00 00 04 (HEX) 00 00 00 08 (HEX) 00 00 00 10 (HEX) 00 00 00 20 (HEX) 00 00 00 40 (HEX) 00 00 00 80 (HEX) 00 00 01 00 (HEX) 00 00 02 00 (HEX) 00 00 04 00 (HEX) 00 00 08 00 (HEX) 00 00 10 00 (HEX) 00 00 20 00 (HEX) 00 00 40 00 (HEX) 00 00 80 00 (HEX) 01 00 00 00 (HEX) 02 00 00 00 (HEX) 04 00 00 00 (HEX) 08 00 00 00 (HEX) 10 00 00 00 (HEX) 20 00 00 00 (HEX) 40 00 00 00 (HEX) 80 00 00 00 (HEX)	00000 (DEC) = No Trips Reported 00001 (DEC) = Undefined (565), Phase A Loset Overcurrent (575) 00002 (DEC) = Undefined (565), Phase B Loset Overcurrent (575) 00004 (DEC) = Undefined (565), Phase C Loset Overcurrent (575) 00008 (DEC) = Undefined (565), Ground Loset Overcurrent (575) 00016 (DEC) = Undefined 00032 (DEC) = Undefined 00064 (DEC) = Undefined 00128 (DEC) = Voltage Phase Reversal 00256 (DEC) = External Switch Trip #1 00512 (DEC) = External Switch Trip #4 (565) 01024 (DEC) = Undefined 02048 (DEC) = Analog Input 04096 (DEC) = Power Factor 08192 (DEC) = Frequency 16384 (DEC) = External Switch Trip #2 (565), Reclosable Trip (575) 32768 (DEC) = External Switch Trip #3 (565), Programmable Trip (575) 6.554 EXP 04 (DEC) = Undefined 1.311 EXP 05 (DEC) = Undefined 2.621 EXP 05 (DEC) = Undefined 5.243 EXP 05 (DEC) = Undefined 1.049 EXP 06 (DEC) = Undefined 2.097 EXP 06 (DEC) = Undefined 4.194 EXP 06 (DEC) = Overvoltage 8.389 EXP 06 (DEC) = Undervoltage 1.678 EXP 07 (DEC) = Phase A Timed O/C 3.355 EXP 07 (DEC) = Phase B Timed O/C 6.711 EXP 07 (DEC) = Phase C Timed O/C 1.342 EXP 08 (DEC) = Ground Timed O/C 2.684 EXP 08 (DEC) = Phase A Inst. O/C (565), Phase A Hiset Overcurrent (575) 5.369 EXP 08 (DEC) = Phase B Inst. O/C (565), Phase B Hiset Overcurrent (575) 1.074 EXP 09 (DEC) = Phase C Inst. O/C (565), Phase C Hiset Overcurrent (575) 2.147 EXP 09 (DEC) = Ground Inst. O/C (565), Ground Hiset Overcurrent (575) Note: Multiple Trips Can Be Reported If Occurring In The Same Cycle Note: This Register Should Be Read As Four Continuous Bytes Note: Only Reading The Upper Address Will Return Zero, As This Register Is Non-existent
F16	16 bits	kW AND kVAR POWER SIGNS
	XXXX XXXX 0000 0000 (BIN) or XX00 (HEX) 0000 0000 XXXX XXXX (BIN) or 00XX (HEX) 0000 0000 0000 0000 (BIN) or 0000 (HEX) 0000 0000 1111 1111 (BIN) or 00FF (HEX) 1111 1111 0000 0000 (BIN) or FF00 (HEX)	Most Significant Byte Contains The Real Power Sign (kW) Least Significant Byte Contains The Reactive Power Sign (kVAR) Example: 00000 (DEC) = Real Power Is Positive, Reactive Power Is Positive 00255 (DEC) = Real Power Is Positive, Reactive Power Is Negative 65280 (DEC) = Real Power Is Negative, Reactive Power Is Positive

565/575 DATA FORMATS (REVISION E2.73)		
FORMAT CODE	APPLICABLE BITS	DEFINITION
	1111 1111 1111 1111 (BIN) or FFFF (HEX)	65535 (DEC) = Real Power Is Negative, Reactive Power Is Negative
F17	16 bits	2's COMPLEMENT (2 BYTE SIGNED INTEGER TO BE MULTIPLIED BY SCALING FACTOR)
	0XXX XXXX XXXX XXXX (BIN) or XXXX (HEX) 0000 0000 0110 0000 (BIN) or 0060 (HEX)	Positive Sign Bit And Magnitude In True Magnitude Form: True Magnitude Form (DEC) * Scaling Factor = Result 0096 (DEC) * 0.01 = 0.96 Leading Power Factor
	1XXX XXXX XXXX XXXX (BIN) or XXXX (HEX) 1111 1111 1010 0101 (BIN) or FFA5 (HEX) 0000 0000 0101 1010 (BIN) or 005A (HEX) 0000 0000 0000 0001 (BIN) or 0001 (HEX) 0000 0000 0101 1011 (BIN) or 005B (HEX)	Negative Sign Bit And Magnitude In 2's Complement Form: 2's Complement Form (DEC) * Scaling Factor = Result {Complement Each Bit And Add 1 To Get The 2's Complement} 0091 (DEC) * 0.01 = 0.91 Lagging Power Factor
F18	16 bits	2's COMPLEMENT (SPECIAL FOR REAL AND REACTIVE POWER)
	0000 0000 XXXX XXXX (BIN) or 00XX (HEX) XXXX XXXX XXXX XXXX (BIN) or XXXX (HEX) 1111 0001 1000 1010 (BIN) or F18A (HEX)	Positive Real Power Sign In Register 006D (HEX) And Magnitude In True Magnitude Form: True Magnitude Form (DEC) * Scaling Factor = Result 61834 (DEC) * 1.00 = 61834 kW
	1111 1111 XXXX XXXX (BIN) or FFXX (HEX) XXXX XXXX XXXX XXXX (BIN) or XXXX (HEX) 1010 1101 1111 1110 (BIN) or ADFE (HEX) 0101 0010 0000 0001 (BIN) or 5201 (HEX) 0000 0000 0000 0001 (BIN) or 0001 (HEX) 0101 0010 0000 0010 (BIN) or 5202 (HEX)	Negative Real Power Sign In Register 006D (HEX) And Magnitude In 2's Complement Form: 2's Complement Form (DEC) * Scaling Factor = Result {Complement Each Bit And Add 1 To Get The 2's Complement} -20994 (DEC) * 1.00 = -20994 kW
	XXXX XXXX 0000 0000 (BIN) or XX00 (HEX) XXXX XXXX XXXX XXXX (BIN) or XXXX (HEX) 1111 1100 1111 0010 (BIN) or FCF2 (HEX)	Positive Reactive Power Sign In Register 006D (HEX) And Magnitude In True Magnitude Form: True Magnitude Form (DEC) * Scaling Factor = Result 64754 (DEC) * 1.00 = 64754 kVAR
	XXXX XXXX 1111 1111 (BIN) or XXFF (HEX) XXXX XXXX XXXX XXXX (BIN) or XXXX (HEX) 1001 1100 1110 1001 (BIN) or 9CE9 (HEX) 0110 0011 0001 0110 (BIN) or 6316 (HEX) 0000 0000 0000 0001 (BIN) or 0001 (HEX) 0110 0011 0001 0111 (BIN) or 6317 (HEX)	Negative Reactive Power Sign In Register 006D (HEX) And Magnitude In 2's Complement Form: 2's Complement Form (DEC) * Scaling Factor = Result {Complement Each Bit And Add 1 To Get The 2's Complement} -25367 (DEC) * 1.00 = -25367 kVAR
F19	16 bits	USER LEVEL SELECTION
	0000 0000 0000 0000 (BIN) or 0000 (HEX) 0000 0000 0000 0001 (BIN) or 0001 (HEX)	00 (DEC) = Basic 01 (DEC) = Advanced
F20	16 bits	SETPOINT STATE SELECTION
	0000 0000 0000 0000 (BIN) or 0000 (HEX) 0000 0000 0000 0001 (BIN) or 0001 (HEX)	00 (DEC) = Enabled 01 (DEC) = Disabled
F21	16 bits	CURVE SHAPE SELECTION
	0000 0000 0000 0000 (BIN) or 0000 (HEX) 0000 0000 0000 0001 (BIN) or 0001 (HEX) 0000 0000 0000 0010 (BIN) or 0002 (HEX) 0000 0000 0000 0011 (BIN) or 0003 (HEX) 0000 0000 0000 0100 (BIN) or 0004 (HEX) 0000 0000 0000 0101 (BIN) or 0005 (HEX) 0000 0000 0000 0110 (BIN) or 0006 (HEX) 0000 0000 0000 0111 (BIN) or 0007 (HEX)	00 (DEC) = Moderately Inverse 01 (DEC) = Normally Inverse 02 (DEC) = Very Inverse 03 (DEC) = Extremely Inverse 04 (DEC) = Custom (565), Custom 1 or Custom 2 (575) 05 (DEC) = IEC A 06 (DEC) = IEC B 07 (DEC) = IEC C
F22	16 bits	OUTPUT CONTACT SELECTION FOR TRIPS
	0000 0000 0000 0000 (BIN) or 0000 (HEX) 0000 0000 0000 0001 (BIN) or 0001 (HEX) 0000 0000 0000 0010 (BIN) or 0002 (HEX) 0000 0000 0000 0011 (BIN) or 0003 (HEX) 0000 0000 0000 0100 (BIN) or 0004 (HEX) 0000 0000 0000 0101 (BIN) or 0005 (HEX) 0000 0000 0000 0110 (BIN) or 0006 (HEX)	00 (DEC) = Trip (565, 575) 01 (DEC) = Aux 1 (565), Trip & Aux 1 (575) 02 (DEC) = Aux 2 (565, 575) 03 (DEC) = Trip & Aux 1 (565) 04 (DEC) = Trip & Aux 2 (565) 05 (DEC) = Aux 1 & 2 (565) 06 (DEC) = Trip & Aux 1 & 2 (565)
F23	16 bits	OUTPUT CONTACT SELECTION FOR ALARMS
	0000 0000 0000 0000 (BIN) or 0000 (HEX) 0000 0000 0000 0001 (BIN) or 0001 (HEX) 0000 0000 0000 0010 (BIN) or 0002 (HEX) 0000 0000 0000 0011 (BIN) or 0003 (HEX)	00 (DEC) = Aux 1 (565), None (575) 01 (DEC) = Aux 2 (565), Aux 1 (575) 02 (DEC) = Aux 1 & 2 (565), Aux 2 (575) 03 (DEC) = Aux 1 & 2 (575)
F24	16 bits	GROUND CURRENT SENSING TYPE SELECTION
	0000 0000 0000 0000 (BIN) or 0000 (HEX) 0000 0000 0000 0001 (BIN) or 0001 (HEX)	00 (DEC) = Residual 01 (DEC) = Zero Sequence
F25	16 bits	COLD LOAD P/U BLOCK TYPE SELECTION
	0000 0000 0000 0000 (BIN) or 0000 (HEX) 0000 0000 0000 0001 (BIN) or 0001 (HEX) 0000 0000 0000 0010 (BIN) or 0002 (HEX)	00 (DEC) = Loset (575) 01 (DEC) = Hiset (575) 02 (DEC) = Both (575)
F26	16 bits	EXTERNAL SWITCH SELECTION
	0000 0000 0000 0000 (BIN) or 0000 (HEX) 0000 0000 0000 0001 (BIN) or 0001 (HEX) 0000 0000 0000 0010 (BIN) or 0002 (HEX)	00 (DEC) = Disabled 01 (DEC) = SW. 1 02 (DEC) = SW. 2

565/575 DATA FORMATS (REVISION E2.73)

FORMAT CODE	APPLICABLE BITS	DEFINITION
	0000 0000 0000 0011 (BIN) or 0003 (HEX)	03 (DEC) = SW. 3
	0000 0000 0000 0100 (BIN) or 0004 (HEX)	04 (DEC) = SW. 4
	0000 0000 0000 0101 (BIN) or 0005 (HEX)	05 (DEC) = SW. 5
	0000 0000 0000 0110 (BIN) or 0006 (HEX)	06 (DEC) = SW. 6
	0000 0000 0000 0111 (BIN) or 0007 (HEX)	07 (DEC) = SW. 7
	0000 0000 0000 1000 (BIN) or 0008 (HEX)	08 (DEC) = SW. 8
F27	16 bits	PROGRAMMABLE SWITCH TRIP OPERATION MODE SELECTION
	0000 0000 0000 0000 (BIN) or 0000 (HEX)	00 (DEC) = Non-Recl. (575)
	0000 0000 0000 0001 (BIN) or 0001 (HEX)	01 (DEC) = Recl. (575)
F28	16 bits	EXTERNAL SWITCH CONFIGURATION/STATUS
	0000 0000 0000 0000 (BIN) or 0000 (HEX)	00 (DEC) = Open
	0000 0000 0000 0001 (BIN) or 0001 (HEX)	01 (DEC) = Closed
F29	16 bits	TRIP RELAY OPERATION MODE SELECTION
	0000 0000 0000 0000 (BIN) or 0000 (HEX)	00 (DEC) = Latched (565)
	0000 0000 0000 0001 (BIN) or 0001 (HEX)	01 (DEC) = Pulsed (565)
F30	16 bits	AUXILIARY RELAY OPERATION MODE SELECTION
	0000 0000 0000 0000 (BIN) or 0000 (HEX)	00 (DEC) = Latched
	0000 0000 0000 0001 (BIN) or 0001 (HEX)	01 (DEC) = Unlatched
	0000 0000 0000 0010 (BIN) or 0002 (HEX)	02 (DEC) = Pulsed
F31	16 bits	EVENT PRINTING OPERATION MODE SELECTION
	0000 0000 0000 0000 (BIN) or 0000 (HEX)	00 (DEC) = Offline
	0000 0000 0000 0001 (BIN) or 0001 (HEX)	01 (DEC) = Online
F32	32 bits	ULONG (SPECIAL FOR ANALOG IN ALARM/TRIP THRESHOLDS)
	XX XX 00 00 (HEX)	Lower Address Contains The Most Significant 16 bits
	00 00 XX XX (HEX)	Upper Address Contains The Least Significant 16 bits
		Example: XXXXXX (DEC) * Scaling Factor = Result Use The Following To Determine The Scaling Factor: (1) [(Maximum Current Scale Value - Minimum Current Scale Value) < 40.89] = 0.01 (2) [(Maximum Current Scale Value - Minimum Current Scale Value) > 40.88] And [(Maximum Current Scale Value - Minimum Current Scale Value) < 408.80] = 0.1 (3) [(Maximum Current Scale Value - Minimum Current Scale Value) > 408.79] = 1.0 Note: Only Reading The Upper Address Will Return Zero, As This Register Is Non-existent
F33	16 bits	ANALOG OUT PARAMETER SELECTION
	0000 0000 0000 0000 (BIN) or 0000 (HEX)	00 (DEC) = Phase A Current
	0000 0000 0000 0001 (BIN) or 0001 (HEX)	01 (DEC) = Phase B Current
	0000 0000 0000 0010 (BIN) or 0002 (HEX)	02 (DEC) = Phase C Current
	0000 0000 0000 0011 (BIN) or 0003 (HEX)	03 (DEC) = Ground Current
	0000 0000 0000 0100 (BIN) or 0004 (HEX)	04 (DEC) = Phase A-X Voltage
	0000 0000 0000 0101 (BIN) or 0005 (HEX)	05 (DEC) = Phase B-X Voltage
	0000 0000 0000 0110 (BIN) or 0006 (HEX)	06 (DEC) = Phase C-X Voltage
	0000 0000 0000 0111 (BIN) or 0007 (HEX)	07 (DEC) = Feeder Frequency
	0000 0000 0000 1000 (BIN) or 0008 (HEX)	08 (DEC) = External Analog Select
F34	16 bits	ANALOG OUT RANGE SELECTION
	0000 0000 0000 0000 (BIN) or 0000 (HEX)	00 (DEC) = 0 - 1 mA
	0000 0000 0000 0001 (BIN) or 0001 (HEX)	01 (DEC) = 4 - 20 mA
F35	16 bits	COMMUNICATION BAUDRATE SELECTION
	0000 0000 0000 0000 (BIN) or 0000 (HEX)	00 (DEC) = 1200 Baud
	0000 0000 0000 0001 (BIN) or 0001 (HEX)	01 (DEC) = 2400 Baud
	0000 0000 0000 0010 (BIN) or 0002 (HEX)	02 (DEC) = 4800 Baud
	0000 0000 0000 0011 (BIN) or 0003 (HEX)	03 (DEC) = 9600 Baud
F36	16 bits	OUTPUT CONTACT TEST SELECTION
	0000 0000 0000 0000 (BIN) or 0000 (HEX)	00 (DEC) = Trip
	0000 0000 0000 0001 (BIN) or 0001 (HEX)	01 (DEC) = Aux 1
	0000 0000 0000 0010 (BIN) or 0002 (HEX)	02 (DEC) = Aux 2
	0000 0000 0000 0011 (BIN) or 0003 (HEX)	03 (DEC) = Aux 3
	0000 0000 0000 0100 (BIN) or 0004 (HEX)	04 (DEC) = All (565), Aux 4 (575)
	0000 0000 0000 0101 (BIN) or 0005 (HEX)	05 (DEC) = Block Tap Change (575)
	0000 0000 0000 0110 (BIN) or 0006 (HEX)	06 (DEC) = All (575)
F37	16 bits	BREAKER OPEN/CLOSE STATUS
	0000 0000 0000 0000 (BIN) or 0000 (HEX)	00 (DEC) = No
	0000 0000 0000 0001 (BIN) or 0001 (HEX)	01 (DEC) = Yes
F38	16 bits	ANALOG SELECT STATUS
	0000 0000 0000 0000 (BIN) or 0000 (HEX)	00 (DEC) = Off
	0000 0000 0000 0001 (BIN) or 0001 (HEX)	01 (DEC) = On
F39	16 bits	LOCAL/REMOTE STATUS
	0000 0000 0000 0000 (BIN) or 0000 (HEX)	00 (DEC) = Local
	0000 0000 0000 0001 (BIN) or 0001 (HEX)	01 (DEC) = Remote
F40	16 bits	VT CONNECTION TYPE SELECTION
	0000 0000 0000 0000 (BIN) or 0000 (HEX)	00 (DEC) = None
	0000 0000 0000 0001 (BIN) or 0001 (HEX)	01 (DEC) = Wye

565/575 DATA FORMATS (REVISION E2.73)		
FORMAT CODE	APPLICABLE BITS	DEFINITION
	0000 0000 0000 0010 (BIN) or 0002 (HEX)	02 (DEC) = Open Delta
	0000 0000 0000 0011 (BIN) or 0003 (HEX)	03 (DEC) = Delta/Wye
F41	16 bits	MTM CT SELECTION
	0000 0000 0000 0000 (BIN) or 0000 (HEX)	00 (DEC) = Common
	0000 0000 0000 0001 (BIN) or 0001 (HEX)	01 (DEC) = Separate
F42	40 bytes	EVENT RECORD DATA
	Data Byte 00	Unused
	Data Byte 01	:
	Data Byte 02	:
	Data Byte 03	Cause Of Event (See Accompanying Cause Of Event Table)
	Data Byte 04	Time Of Event (See F13)
	Data Byte 05	:
	Data Byte 06	:
	Data Byte 07	:
	Data Byte 08	Date Of Event (See F13)
	Data Byte 09	:
	Data Byte 10	:
	Data Byte 11	:
	Data Byte 12	Phase A Current (See Accompanying Number Format Description)
	Data Byte 13	:
	Data Byte 14	:
	Data Byte 15	:
	Data Byte 16	Phase B Current (See Accompanying Number Format Description)
	Data Byte 17	:
	Data Byte 18	:
	Data Byte 19	:
	Data Byte 20	Phase C Current (See Accompanying Number Format Description)
	Data Byte 21	:
	Data Byte 22	:
	Data Byte 23	:
	Data Byte 24	Ground Current (See Accompanying Number Format Description)
	Data Byte 25	:
	Data Byte 26	:
	Data Byte 27	:
	Data Byte 28	Voltage A-X (See Accompanying Number Format Description)
	Data Byte 29	:
	Data Byte 30	:
	Data Byte 31	:
	Data Byte 32	Voltage B-X (See Accompanying Number Format Description)
	Data Byte 33	:
	Data Byte 34	:
	Data Byte 35	:
	Data Byte 36	Voltage C-X (See Accompanying Number Format Description)
	Data Byte 37	:
	Data Byte 38	:
	Data Byte 39	:

CAUSE OF EVENT TABLE

(*) = Only Those Events Marked With An Asterisk Will Have Their Current And Voltage Parameters Recorded.

- 01_{HEX} (*) Phase A Timed Overcurrent Trip (565, 575)
- 02_{HEX} (*) Phase B Timed Overcurrent Trip (565, 575)
- 03_{HEX} (*) Phase C Timed Overcurrent Trip (565, 575)
- 04_{HEX} (*) Ground Timed Overcurrent Trip (565, 575)
- 05_{HEX} (*) Phase A Instantaneous Overcurrent Trip (565)
- 06_{HEX} (*) Phase B Instantaneous Overcurrent Trip (565)
- 07_{HEX} (*) Phase C Instantaneous Overcurrent Trip (565)
- 08_{HEX} (*) Ground Instantaneous Overcurrent Trip (565)
- 09_{HEX} (*) Phase A Hiset Instantaneous Trip (575)
- 0A_{HEX} (*) Phase B Hiset Instantaneous Trip (575)
- 0B_{HEX} (*) Phase C Hiset Instantaneous Trip (575)
- 0C_{HEX} (*) Ground Hiset Instantaneous Trip (575)
- 0D_{HEX} (*) Phase A Loset Instantaneous Trip (575)
- 0E_{HEX} (*) Phase B Loset Instantaneous Trip (575)
- 0F_{HEX} (*) Phase C Loset Instantaneous Trip (575)
- 10_{HEX} (*) Ground Loset Instantaneous Trip (575)
- 11_{HEX} (*) Overvoltage Trip (565, 575)
- 12_{HEX} (*) Undervoltage Trip (565, 575)
- 13_{HEX} Analog Input Trip (565, 575)
- 14_{HEX} External Trip #1 (565)
- 15_{HEX} External Trip #2 (565)

565/575 DATA FORMATS (REVISION E2.73)

FORMAT CODE	APPLICABLE BITS	DEFINITION
		16 _{HEX} External Trip #3 (565)
		17 _{HEX} External Trip #4 (565)
		18 _{HEX} External Trip (575)
		19 _{HEX} Reclosable Trip (575)
		1A _{HEX} Programmable Trip (575)
		1B _{HEX} Power Factor Trip (565, 575)
		1C _{HEX} Frequency Trip (565, 575)
		1D _{HEX} Voltage Phase Reversal Trip (565, 575)
		1E _{HEX} Phase Overcurrent Alarm (565, 575)
		1F _{HEX} Ground Overcurrent Alarm (565, 575)
		20 _{HEX} Overvoltage Alarm (565, 575)
		21 _{HEX} Undervoltage Alarm (565, 575)
		22 _{HEX} Analog Input Alarm (565, 575)
		23 _{HEX} Accumulated KA Alarm (565, 575)
		24 _{HEX} Switch Alarm #1 (565, 575)
		25 _{HEX} Switch Alarm #2 (565, 575)
		26 _{HEX} Amps Demand Alarm (565, 575)
		27 _{HEX} kW Demand Alarm (565, 575)
		28 _{HEX} kVAR Demand Alarm (565, 575)
		29 _{HEX} Power Factor Alarm (565, 575)
		2A _{HEX} Frequency Alarm (565, 575)
		2B _{HEX} Breaker Discrepancy Alarm (565, 575)
		2C _{HEX} Trip Coil Alarm (565, 575)
		2D _{HEX} MTM Communication Alarm (565, 575)
		2E _{HEX} Phase Overcurrent Alarm Reset (565, 575)
		2F _{HEX} Ground Overcurrent Alarm Reset (565, 575)
		30 _{HEX} Overvoltage Alarm Reset (565, 575)
		31 _{HEX} Undervoltage Alarm Reset (565, 575)
		32 _{HEX} Analog Input Alarm Reset (565, 575)
		33 _{HEX} Switch Alarm #1 Reset (565, 575)
		34 _{HEX} Switch Alarm #2 Reset (565, 575)
		35 _{HEX} Breaker Alarm Reset (565, 575)
		36 _{HEX} Access Jumper Installed (565, 575)
		37 _{HEX} Access Jumper Removed (565, 575)
		38 _{HEX} Block Instantaneous Trip Enabled (565, 575)
		39 _{HEX} Block Instantaneous Trip Disabled (565, 575)
		3A _{HEX} Block Timed Trips Enabled (565, 575)
		3B _{HEX} Block Timed Trips Disabled (565, 575)
		3C _{HEX} Curve Adjust Enabled (565, 575)
		3D _{HEX} Curve Adjust Disabled (565, 575)
		40 _{HEX} Illegal Setpoint Access (565, 575)
		41 _{HEX} System Manual Reset (565, 575)
		42 _{HEX} Reclosure Enabled (575)
		43 _{HEX} Reclosure Disabled (575)
		44 _{HEX} Control Switch to Remote (565, 575)
		45 _{HEX} Control Switch to Local (565, 575)
		46 _{HEX} Reclosure #1 (575)
		47 _{HEX} Reclosure #2 (575)
		48 _{HEX} Reclosure #3 (575)
		49 _{HEX} Reclosure #4 (575)
		4A _{HEX} Reclosure Lockout (575)
		4B _{HEX} Reclosure Scheme Reset (575)
		4C _{HEX} Serial Communication Trip (565, 575)
		4D _{HEX} Serial Communication Close (565, 575)
NUMBER FORMAT DISCRPTION		
	00000000 00000000 00000000 00000000 (BIN)	Sign Bit (0 = Positive, 1 = Negative)
	0XXXXXXXX X0000000 00000000 00000000 (BIN)	Exponent Blts
	00000000 0XXXXXXXX XXXXXXXXXX XXXXXXXXXX (BIN)	Mantissa Blts
		Example:
	01000011 01001110 11101101 10110011 (BIN)	Sign ($2^{-(\text{Exponent}-150)}$) X ($2^{23} + \text{Mantissa}$) = Result
	0XXXXXXXX XXXXXXXXXX XXXXXXXXXX XXXXXXXXXX (BIN)	Sign = +
	X1000011 0XXXXXXXX XXXXXXXXXX XXXXXXXXXX (BIN)	Exponent = 86(HEX) = 134(DEC)
	XXXXXXXX X1001110 11101101 10110011 (BIN)	Mantissa = 4EEDB3(HEX) = 5172659(DEC)
		+ ($2^{-(134-150)}$) X ($2^{23} + 5172659$) = 206.93 Amps or Volts

Metering Specification - 565/575 with MTM

The Metering Transducer Module is an optional unit which can be connected to the 565/575 unit to give additional functionality. The MTM is used to obtain data for specific functions which are displayed in the 565/575 or used for further processing. **** 565 requires Option Card ****

Metering Functions

The following data is supplied by the MTM to the 565/575:

- Power Factor
- Frequency
- Kilowatts (kW)
- Kilovars (kVAR)
- Megawatthours (MWhr)

Various alarms and trip levels are set in the 565 for the above parameters as required.

The following levels are derived from MTM data and calculated in the 565/575. They are:

- Kilowatt Demand
- Kilovars Demand

MTM Communications

The 565/575 communicates with the MTM via a dedicated port and uses a proprietary protocol.

Port Information

The dedicated port uses the RS485 type arrangement and requires a shielded twisted pair cable. The MTM is used as a slave and responds only after a request by the 565/575. A request is sent every 500 ms. The MTM responds with data which must occur within a set period of time.

A checksum of the data packet is used to verify data transmissions. If an error has occurred or the MTM will not respond, the 565/575 will resend the request. In the event that the 565/575 has requested data three times and no response has been received an MTM communications alarm will occur, if enabled.

Revision Number

A revision Number is used in the transmission protocol between the MTM and the 565/575 to identify the software level in the 565/575 and the MTM. If the revisions are not compatible then an MTM communications alarm is declared.

Function Enhancement with MTM

The following functions with their specifications become available when an MTM and Option Card has been added to the 565/575.

Power Factor

Ratio of real power (kW) to apparent power (kVAR). The range is from 0 leading (+ve values) to 1 to 0 lagging (-ve values) to 1.

Setpoints:

Alarm level	0 leading to 1 and 0 lagging to 1, in steps of 0.05. Default values 0.75 leading and lagging.
Alarm delay	1-127 sec, in steps of 0.5 sec. Default 5 seconds.
Alarm relay	AUX 1, 2 and AUX 1&2. Default AUX 1.
Trip level	0 leading to 1 and 0 lagging to 1, in steps of 0.05. Default values 0.7 leading and lagging.
Trip delay	1-127 sec, in steps of 0.5 sec. Default 1 second.
Trip relay	TRIP, AUX 1, 2, TRIP & AUX1, TRIP & AUX2, AUX 1&2, and TRIP & AUX 1&2. Default AUX 1.

Frequency

Line frequency measured between the phases A and B voltages.

The range is 40-72 Hz. This allows for measurements of up to $\pm 20\%$ of 50 or 60 Hz. The resolution is 0.1 Hz.

Setpoints:

Alarm level	40-60Hz for Underfrequency and 50-72Hz for Overfrequency, in steps of 0.1 Hz. Default value 58 and 62 for Under/Over freq.
Alarm delay	1-127 sec, in steps of 0.5 sec. Default value 5 seconds.
Alarm relay	AUX 1, 2, and AUX 1&2. Default AUX 1.
Trip level	40-60Hz for Underfrequency and 50-72Hz for Overfrequency, in steps of 0.1 Hz. Default value 56 and 64 for Under/Over freq.
Trip delay	1-127 sec, in steps of 0.5 sec. Default value 1 second.
Trip relay	TRIP, AUX 1, 2, TRIP & AUX1, TRIP & AUX2, AUX 1&2, and TRIP & AUX 1&2. Default AUX 1.

kW

This measures real power and is supplied by the MTM for metering purposes only. There are no alarm or trip functions.

Range is up to 65 000 kW (65 MW).

Accuracy is $\pm 2\%$ of displayed.

Resolution display is 1 kW.

kVAR

This is a measure of reactive power. This value is supplied by the MTM and is for metering purposes only. There are no alarm or trip functions.

FEATURE INFORMATION



Range is up to 65 000 kVAR (65 MVAR).
Accuracy is $\pm 2\%$ of displayed.
Resolution display is 1 kVAR.

Signed Real and Reactive Power Readings

If the 565/575 is communicating with a revision E MTM or MTM Plus, the kW and kvar readings sent to the 565/575 will also include the polarity sign. The 565/575 will display this information as shown below.

REAL POWER
+VE 65 000 kW

REACTIVE POWER
+VE 65 000 kW

To interpret the real power readings at Modbus register 70h and the reactive power readings at Modbus register 71h, one must first read register 6Dh. This latter register indicates the sign of the real and reactive power readings. Refer to the 565/575 DATA MAP for an explanation of the data format for register 60h. With knowledge of the real and reactive power signs, the formatting of the Power Data at register 70h and 71h is indicated in the 565/575 Data Map.

Generally, if the sign at data register 6Dh is zero, the corresponding data can be read directly. If the sign data at register 6Dh is not zero, a 2's complement operation should be performed on the data first.

MWhrs

This is real power used. This value is supplied by the MTM and is for metering purposes only. There are no alarm or trip functions.

Range is up to 65 000 MWhrs.
Accuracy is $\pm 2\%$ of displayed.
Resolution displayed is 1 MWhr.

kW Demand

This measures average real power demanded over time. The kW value is supplied by the MTM while the demand value is averaged by the 565.

Setpoints:

Time period 5-120 min, in steps of 1 min. Default value 5 minutes.
Alarm level 100 - 65 000 kW in steps of 100 kW. Default value 1 000 kW.
Alarm relay AUX 1, 2, and AUX 1&2. Default AUX 1.

kVAR Demand

This measures average reactive power demanded over time. This value is supplied by the MTM but averaged by the 565.

Setpoints:

Time period 5-120 min, in steps of 1 min. Default value 5 minutes.
Alarm level 100 - 65 000 kVAR in steps of 100 kVAR. Default value 1 000 kVAR.
Alarm relay AUX 1, 2, and AUX 1&2. Default AUX 1.

The 565/575 contains a line which allows the clearing of the MWhrs data calculated by the MTM/MTM Plus. This setpoint can be found in the Actual Values Metering Data page and appears as below:

CLEAR ENERGY USED DATA? NO
--

This MTM/MTM Plus parameter can also be cleared with the Modbus "Force Single Coil" function code 05h and operation code 15h.

Retrieval of Event Records via Serial Communication

To facilitate the retrieval of event records, a register called the Start of Event Queue is implemented at memory location 19h. The low order byte of this register gives the record number of the most recent event (0 to 27h). The high order byte is a free running wraparound counter incremented every 40 events. The Start of Event Queue register will be reset to zero if the event recorder is cleared.

For the first 40 events, the Start of Event Queue register will read 00h. In this case, the record number of the most recent event will correspond to the Number of Events found at register 74h. With more than 40 events, the record number of the most recent event will be the lower order byte of the Start of Event Queue register. A reading of 00h in this lower order byte coincides with event record 28h.

The event record number points to the following memory map addresses:

RECORD 01h – 600h	RECORD 15h – 790h
RECORD 02h – 614h	RECORD 16h – 7A4h
RECORD 03h – 628h	RECORD 17h – 7B8h
RECORD 04h – 63Ch	RECORD 18h – 7CCh
RECORD 05h – 650h	RECORD 19h – 7E0h
RECORD 06h – 664h	RECORD 1Ah – 7F4h
RECORD 07h – 678h	RECORD 1Bh – 808h
RECORD 08h – 68Ch	RECORD 1Ch – 81Ch
RECORD 09h – 6A0h	RECORD 1Dh – 830h
RECORD 0Ah – 6B4h	RECORD 1Eh – 844h
RECORD 0Bh – 6C8h	RECORD 1Fh – 858h
RECORD 0Ch – 6DCh	RECORD 20h – 86Ch
RECORD 0Dh – 6F0h	RECORD 21h – 880h
RECORD 0Eh – 704h	RECORD 22h – 894h
RECORD 0Fh – 718h	RECORD 23h – 8A8h
RECORD 10h – 72Ch	RECORD 24h – 8BCh
RECORD 11h – 740h	RECORD 25h – 8D0h
RECORD 12h – 754h	RECORD 26h – 8E4h
RECORD 13h – 768h	RECORD 27h – 8F8h
RECORD 14h – 77Ch	RECORD 28h – 90Ch

Each of the event records is composed of 40 bytes as shown below:

DATA BYTE	DEFINITION	FORMAT
0-2	Unused	
3	Cause of event	Refer to next table
4-7	Time of event	Binary (-, Second, Minute, Hour)
8-11	Date of event	Binary (-, Day, Month, Year)
12-15	Phase A Current <i>(If applicable)</i>	Unsigned long integer
16-19	Phase B Current <i>(If applicable)</i>	Unsigned long integer
20-23	Phase C Current <i>(If applicable)</i>	Unsigned long integer
24-27	Ground Current <i>(If applicable)</i>	Unsigned long integer
28-31	Voltage A <i>(Phase/Line, if applicable)</i>	Unsigned long integer
32-35	Voltage B <i>(Phase/Line, if applicable)</i>	Unsigned long integer
36-39	Voltage C <i>(Phase/Line, if applicable)</i>	Unsigned long integer

The phase currents, ground current, and phase voltages are of a double precision number format which is composed of 1 sign bit, 8 exponential bits, and 23 mantissa bits.

The following lists the possible events and the corresponding hexadecimal number which will be found at byte 3 of each event record. Only those events marked with an asterisk will have their current and voltage parameters recorded.

EVENT NO	DESCRIPTION	APPLICABLE TO
01h (*)	Phase A timed overcurrent trip	565/575
02h (*)	Phase B timed overcurrent trip	565/575
03h (*)	Phase C timed overcurrent trip	565/575
04h (*)	Ground timed overcurrent trip	565/575
05h (*)	Phase A inst. overcurrent trip	565
06h (*)	Phase B inst. overcurrent trip	565
07h (*)	Phase C inst. overcurrent trip	565
08h (*)	Ground inst. overcurrent trip	565
09h (*)	Phase A hiset instantaneous trip	575

EVENT NO	DESCRIPTION	APPLICABLE TO
0Ah (*)	Phase B hiset instantaneous trip	575
0Bh (*)	Phase C hiset instantaneous trip	575
0Ch (*)	Ground hiset instantaneous trip	575
0Dh (*)	Phase A loiset instantaneous trip	575
0Eh (*)	Phase B loiset instantaneous trip	575
0Fh (*)	Phase C loiset instantaneous trip	575
10h (*)	Ground loiset instantaneous trip	575
11h (*)	Overvoltage trip	565/575
12h (*)	Undervoltage trip	565/575
13h	Analog input trip	565/575
14h (*)	External trip #1	565
15h (*)	External trip #2	565
16h (*)	External trip #3	565
17h (*)	External trip #4	565
18h (*)	External trip	575
19h (*)	Reclosable trip	575
1Ah (*)	Programmable trip	575
1Bh	Power factor trip	565/575
1Ch	Frequency trip	565/575
1Dh	Voltage phase reversal trip	565/575
1Eh	Phase overcurrent alarm	565/575
1Fh	Ground overcurrent alarm	565/575
20h	Overvoltage alarm	565/575
21h	Undervoltage alarm	565/575
22h	Analog input alarm	565/575
23h	Accumulated KA alarm	565/575
24h	Switch alarm #1	565/575
25h	Switch alarm #2	565/575
26h	Amps demand alarm	565/575
27h	kW demand alarm	565/575
28h	kvar demand alarm	565/575
29h	Power factor alarm	565/575
2Ah	Frequency alarm	565/575
2Bh	Breaker discrepancy alarm	565/575
2Ch	Trip coil alarm	565/575
2Dh	MTM communication alarm	565/575
2Eh	Phase overcurrent alarm reset	565/575
2Fh	Ground overcurrent alarm reset	565/575
30h	Overvoltage alarm reset	565/575
31h	Undervoltage alarm reset	565/575
32h	Analog input alarm reset	565/575
33h	Switch alarm #1 reset	565/575
34h	Switch alarm #2 reset	565/575
35h	Breaker alarm reset	565/575
36h	Access jumper installed	565/575
37h	Access jumper removed	565/575
38h	Block instantaneous trip enabled	565/575
39h	Block instantaneous trip disabled	565/575
3Ah	Block timed trips enabled	565/575
3Bh	Block timed trips disabled	565/575
3Ch	Curve adjust enabled	565/575
3Dh	Curve adjust disabled	565/575
40h	Illegal setpoint access	565/575
41h	System manual reset	565/575
42h	Reclosure enabled	575
43h	Reclosure disabled	575
44h	Control switch to remote	565/575
45h	Control switch to local	565/575
46h	Reclosure #1	575
47h	Reclosure #2	575

FEATURE INFORMATION



<u>EVENT NO</u>	<u>DESCRIPTION</u>	<u>APPLICABLE TO</u>
48h	Reclosure #3	575
49h	Reclosure #4	575
4Ah	Reclosure lockout	575
4Bh	Reclosure scheme reset	575
4Ch	Serial communication trip	565/575
4Dh	Serial communication close	565/575

www.ElectricalPartManuals.com

www.ElectricalPartManuals.com

Overcurrent Protection

The 565/575 Relay continuously monitors the three phase currents and ground current in the feeder through its CT's and initiates an alarm and/or feeder breaker trip if any rise above the pick-up level. The setting for phase and ground are independent of each other and the time for either action to be initiated is based on the chosen time/overcurrent curve and overload level. Note that smaller overcurrents can be tolerated for longer periods than larger ones.

The 565/575 Relay allows the following curves to be chosen:

1. Moderately Inverse.
2. Normal Inverse.
3. Very Inverse.
4. Extremely Inverse.
5. IEC A
6. IEC B
7. IEC C
8. Programmable Curve

Use of Standard Curves

If it is intended to use the standard curves, for overcurrent protection, then the curve shape and number must be determined and entered into the 565/575 Relay. For each shape, there are 32 different curves corresponding to a different time dial. The selection of protection curve shape, pick-ups and time dial must be determined from a system co-ordination study. To determine the curve shape and number most suited to your system proceed as follows:

Plot the time/overcurrent characteristics of all the related system equipment to the feeder on a blank log/log sheet. Alternately only the most critical items may be plotted. This is called the System Plot.

Now choose an overcurrent value on the system plot, preferably the one which is most critical to the device being protected. Next select the standard curve shape which most closely matches the time/overcurrent characteristics of the item to be protected. Finally, the curve number must be selected to position this curve in the correct vertical location.

The standard curves which are programmed into the 565/575 relay are shown in Figure 7.1 through Figure 7.8.

Use of Custom Curve

In addition to the standard curves, the 565/575 Relay also has a user-programmable curve. This curve can be defined by the user and thus be closely matched to the needs of the particular application. This is a vast improvement on conventional feeder protection devices which forced the user to compromise on protection by using a standard curve which might not exactly match the protection requirements of the particular system.

Alternately, the custom curve can be used to match the system requirements very closely.

CAUTION

Ensure when selecting a curve, either preprogrammed or custom, and the delays to trip the feeder breaker, that the maximum current into the relay at the rear terminals of the 565 shall not exceed 100A for more than 3 seconds.

Failure to ensure the maximum current vs. delay can cause damage to the relay which may result in loss of relay protection.

Example: Any time a pickup level is selected greater than 100% of CT using the 5A tap, care must be taken to ensure that current to the relay is limited to 100A for 3 seconds maximum. If a pickup level of 150% is selected with a maximum of 20 times pickup then 150A will be flowing into the 565 relay. Therefore, an instantaneous trip must be selected for any current above 100A. ie. $13.3 \times$ pickup level.

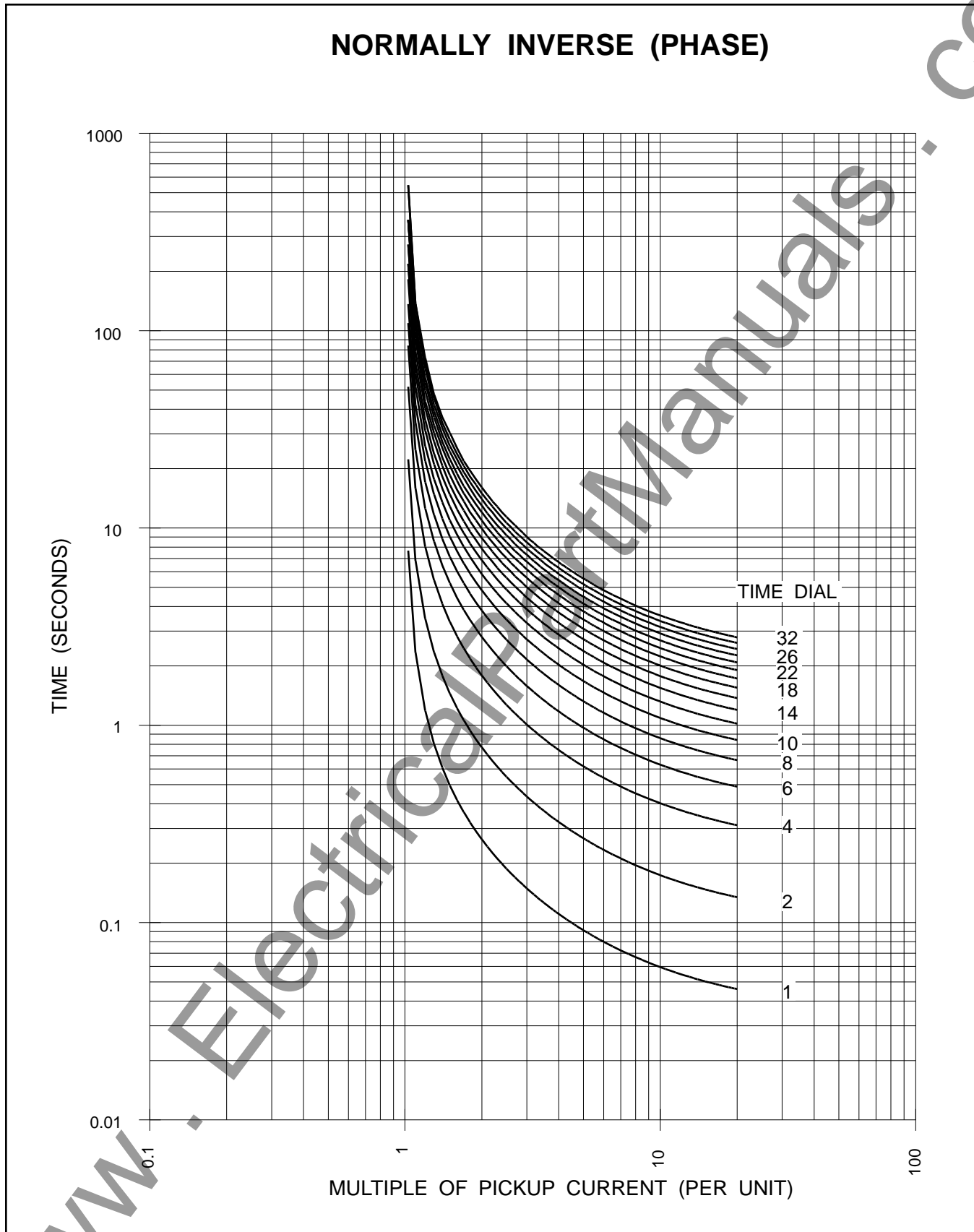

Figure 7.1 Normal Inverse Time/Phase Overcurrent Curves

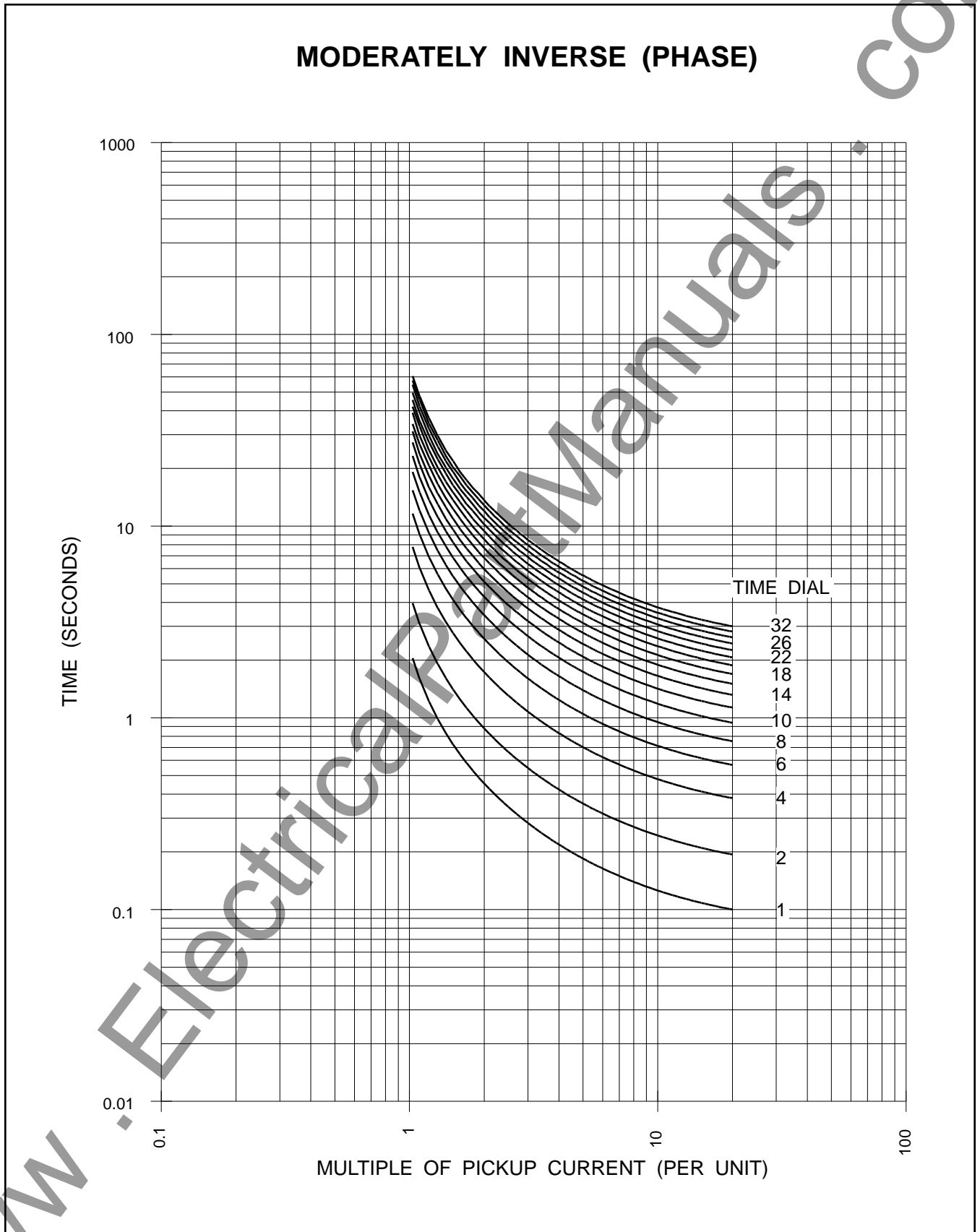

Figure 7.2 Moderately Inverse Time/Phase Overcurrent Curves

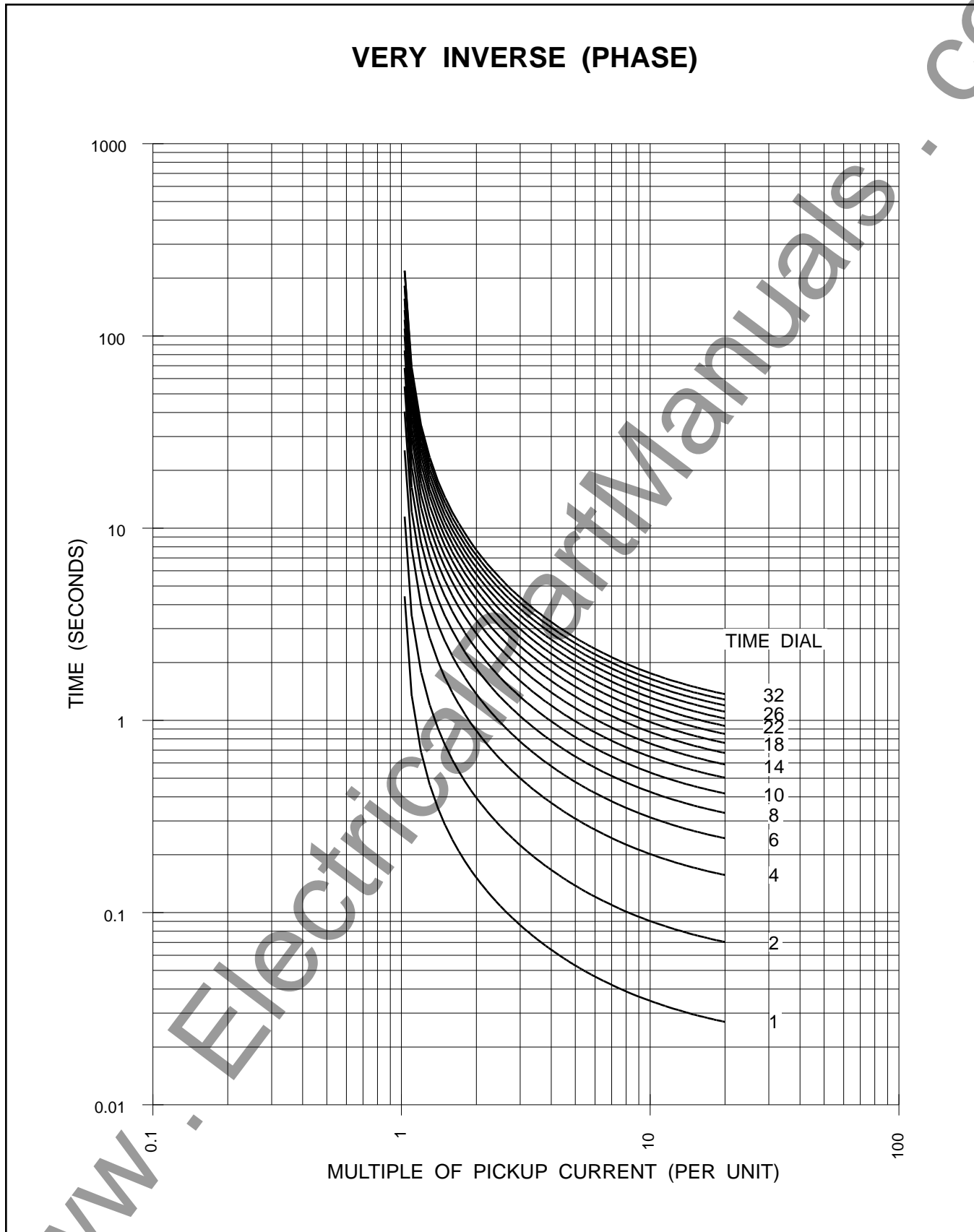

Figure 7.3 Very Inverse Time/Phase Overcurrent Curves

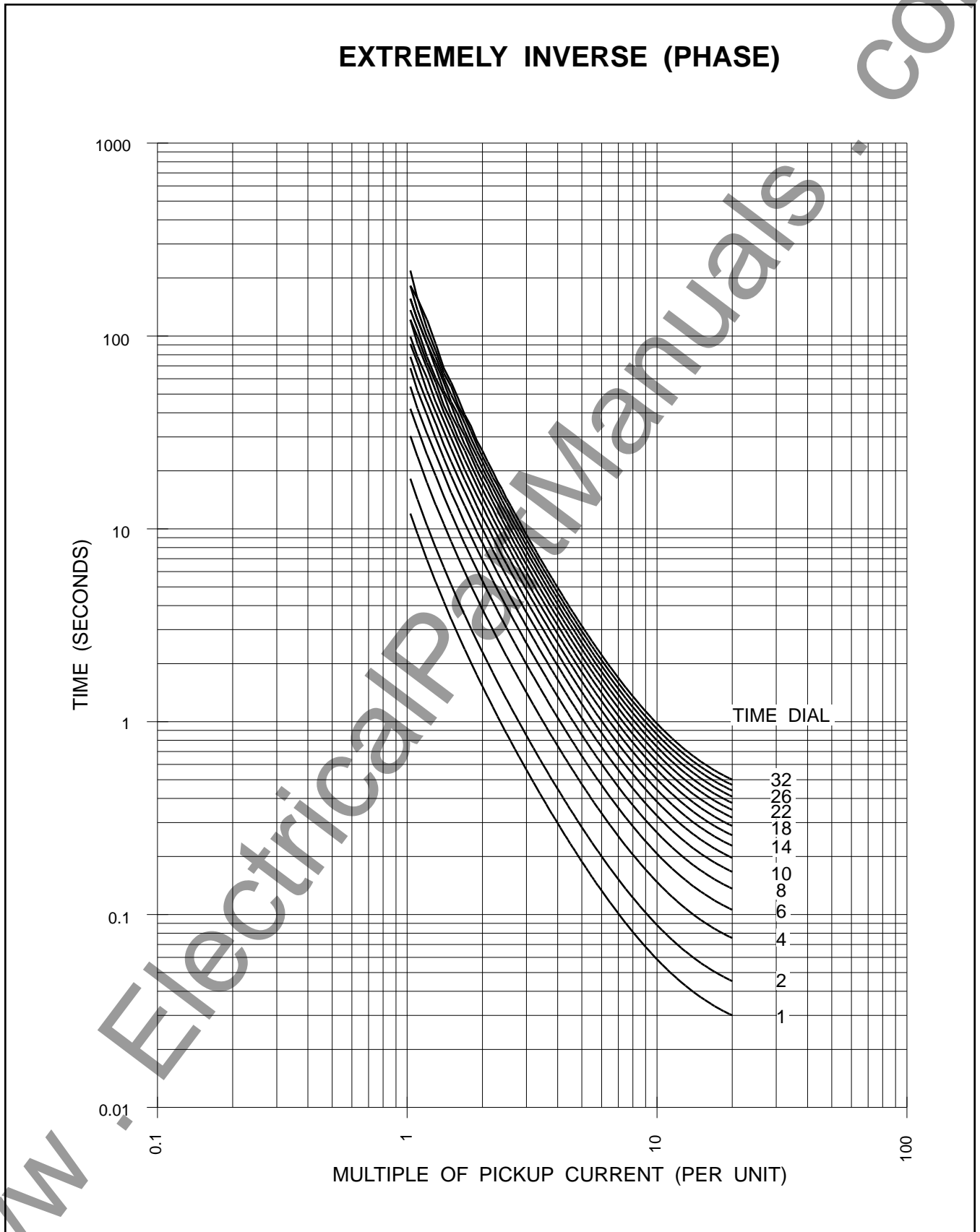

Figure 7.4 Extremely Inverse Time/Phase Overcurrent Curves

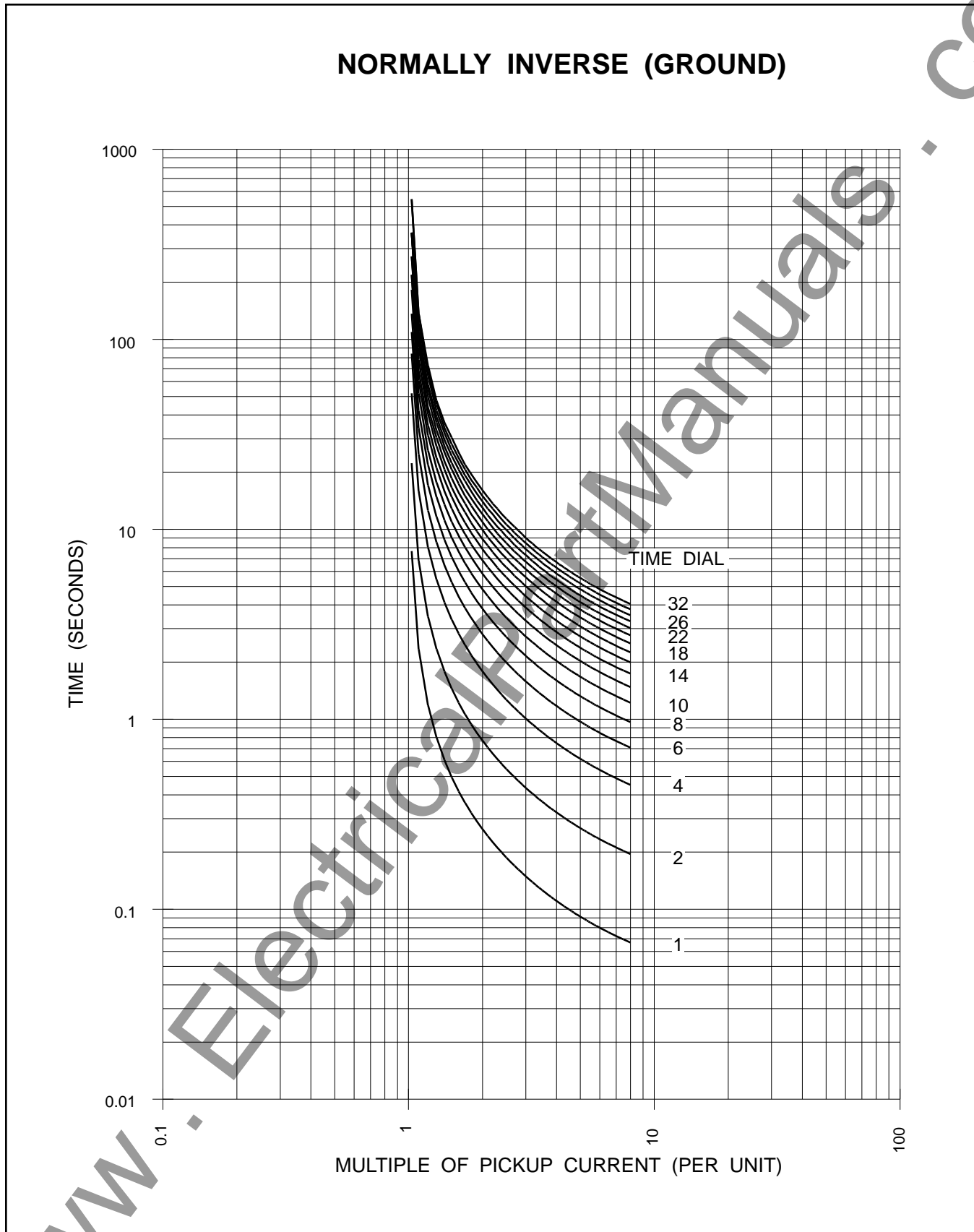

Figure 7.5 Normal Inverse Time/Ground Overcurrent Curves

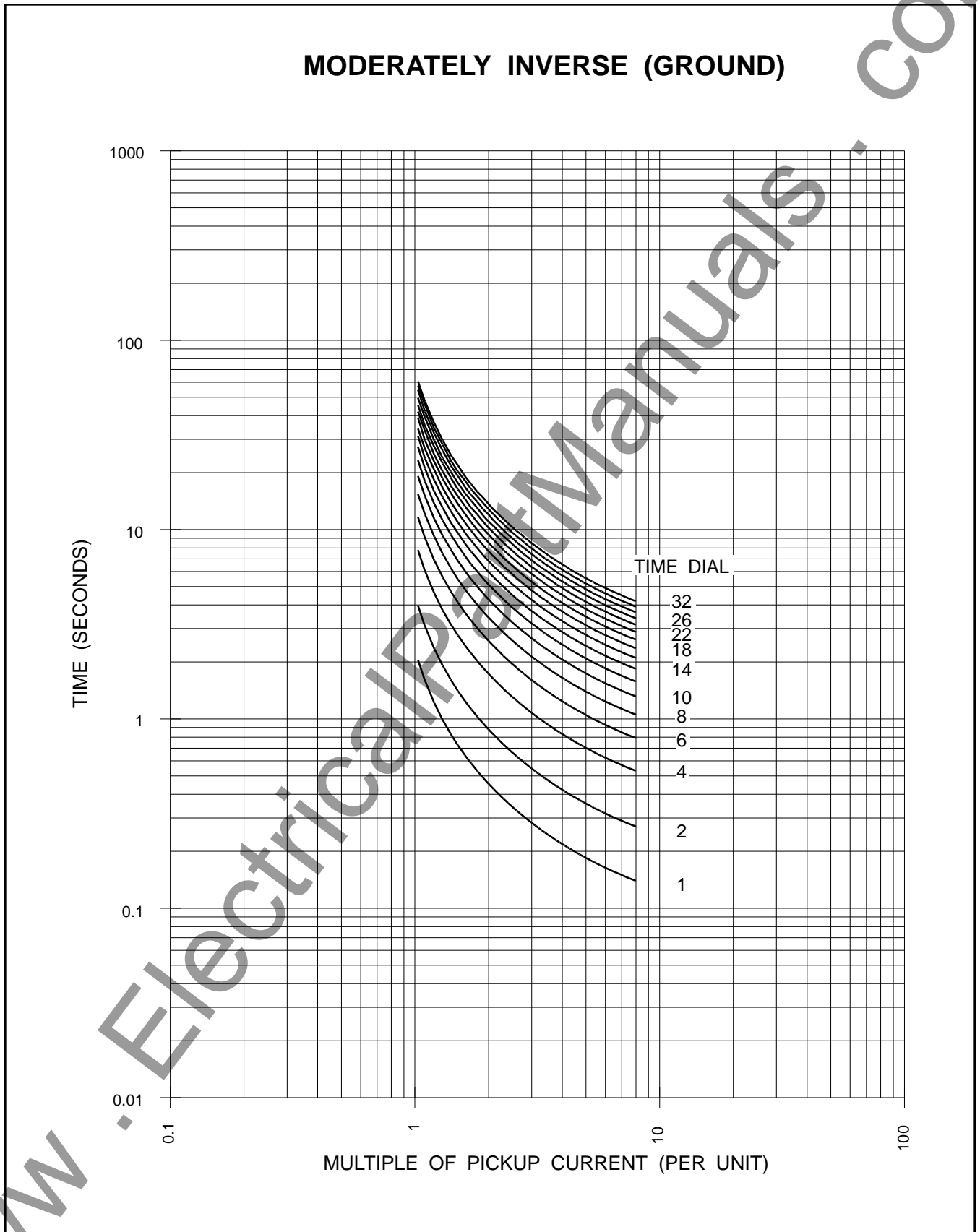

Figure 7.6 Moderately Inverse Time/Ground Overcurrent Curves

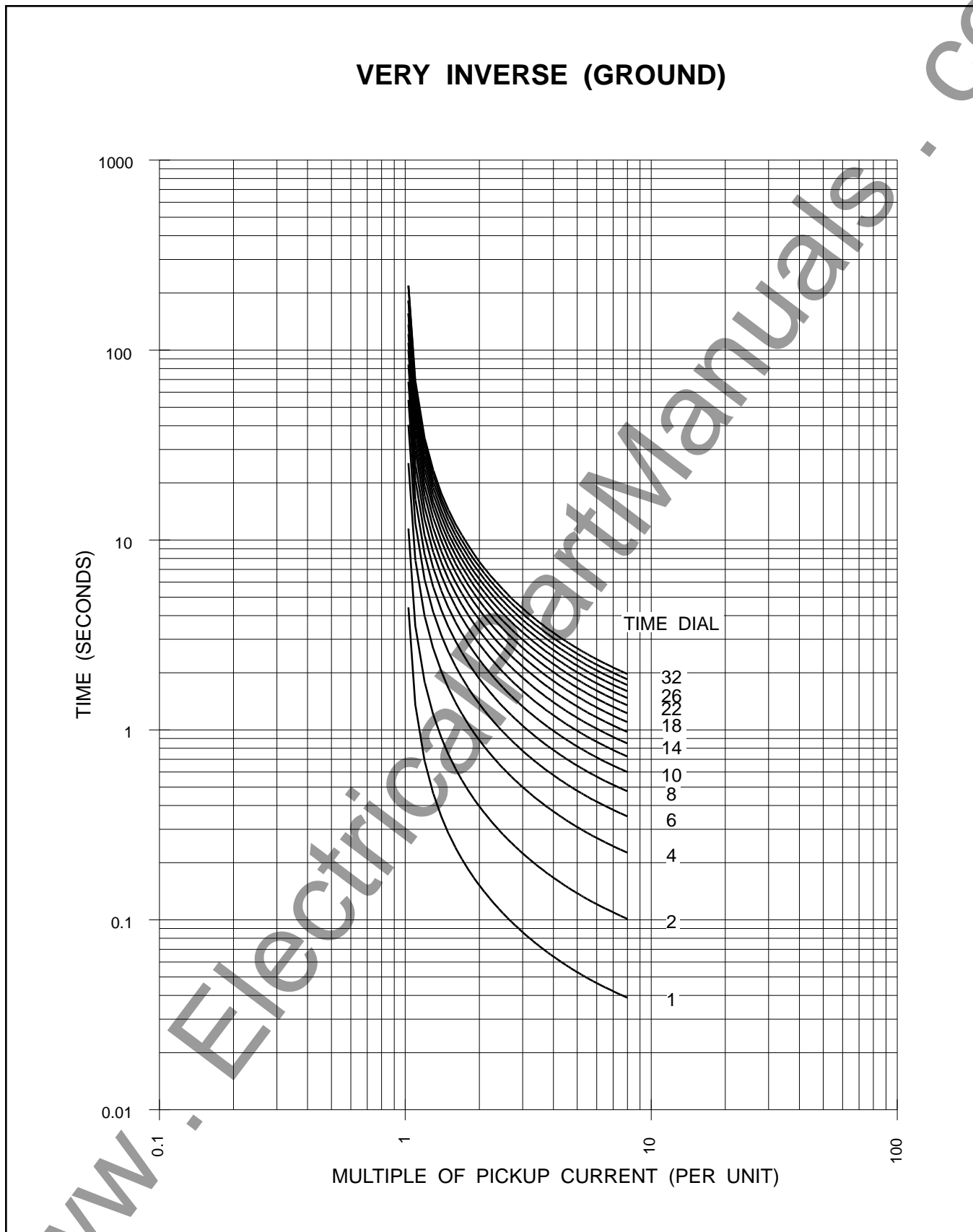

Figure 7.7 Very Inverse Time/Ground Overcurrent Curves

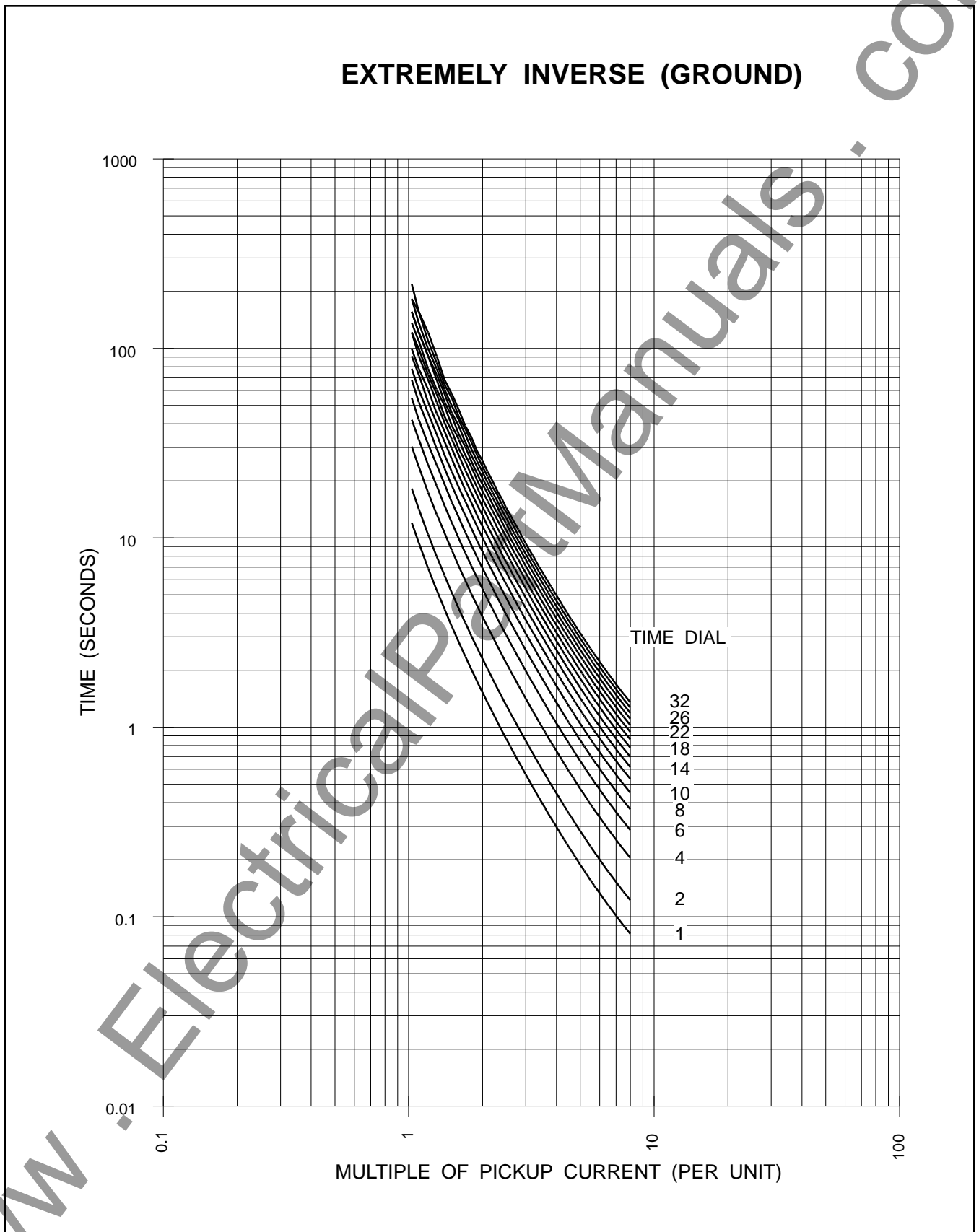

Figure 7.8 Extremely Inverse Time/Ground Overcurrent Curves



Figure 7.9 IEC A Curves

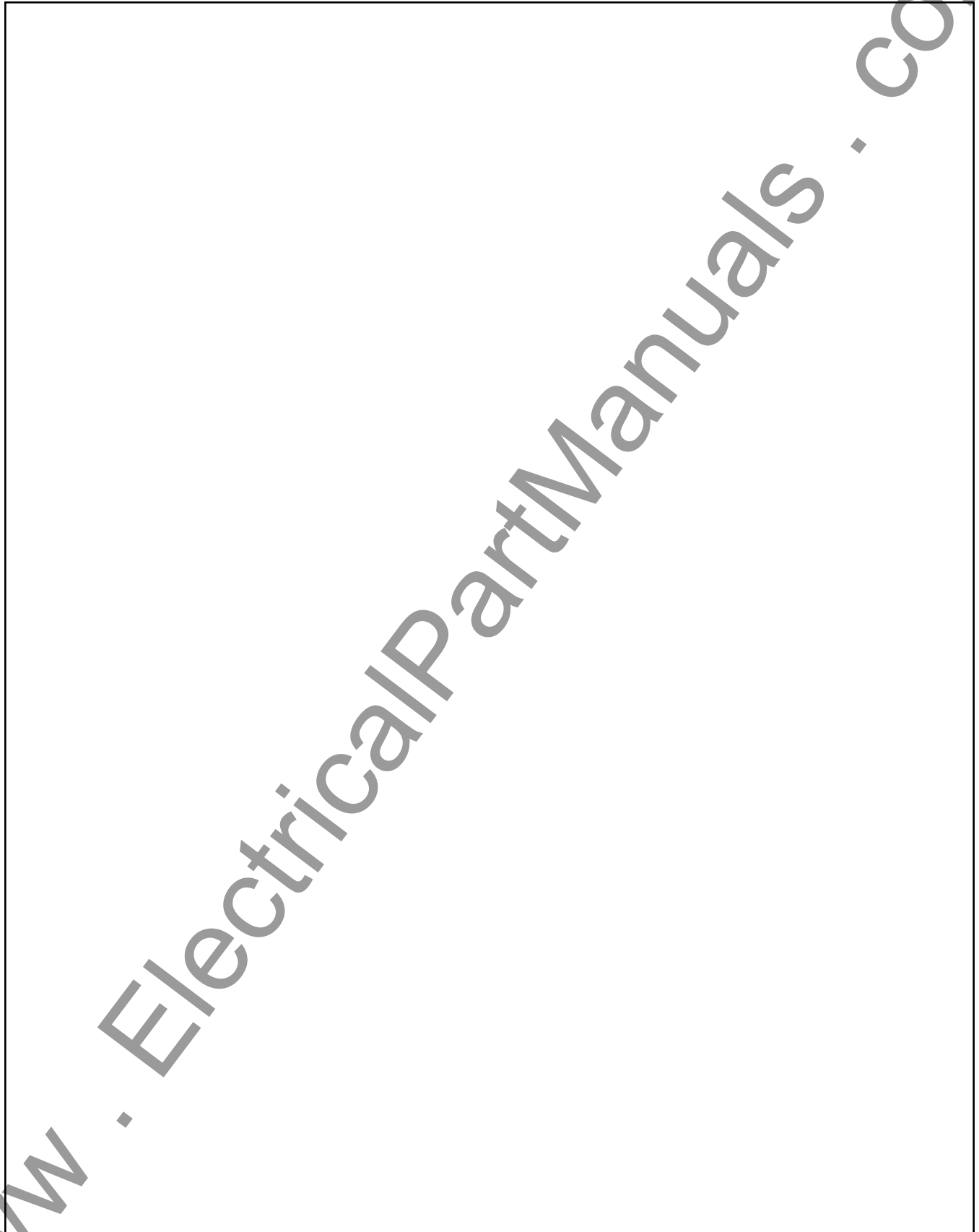

Figure 7.10 IEC B Curves

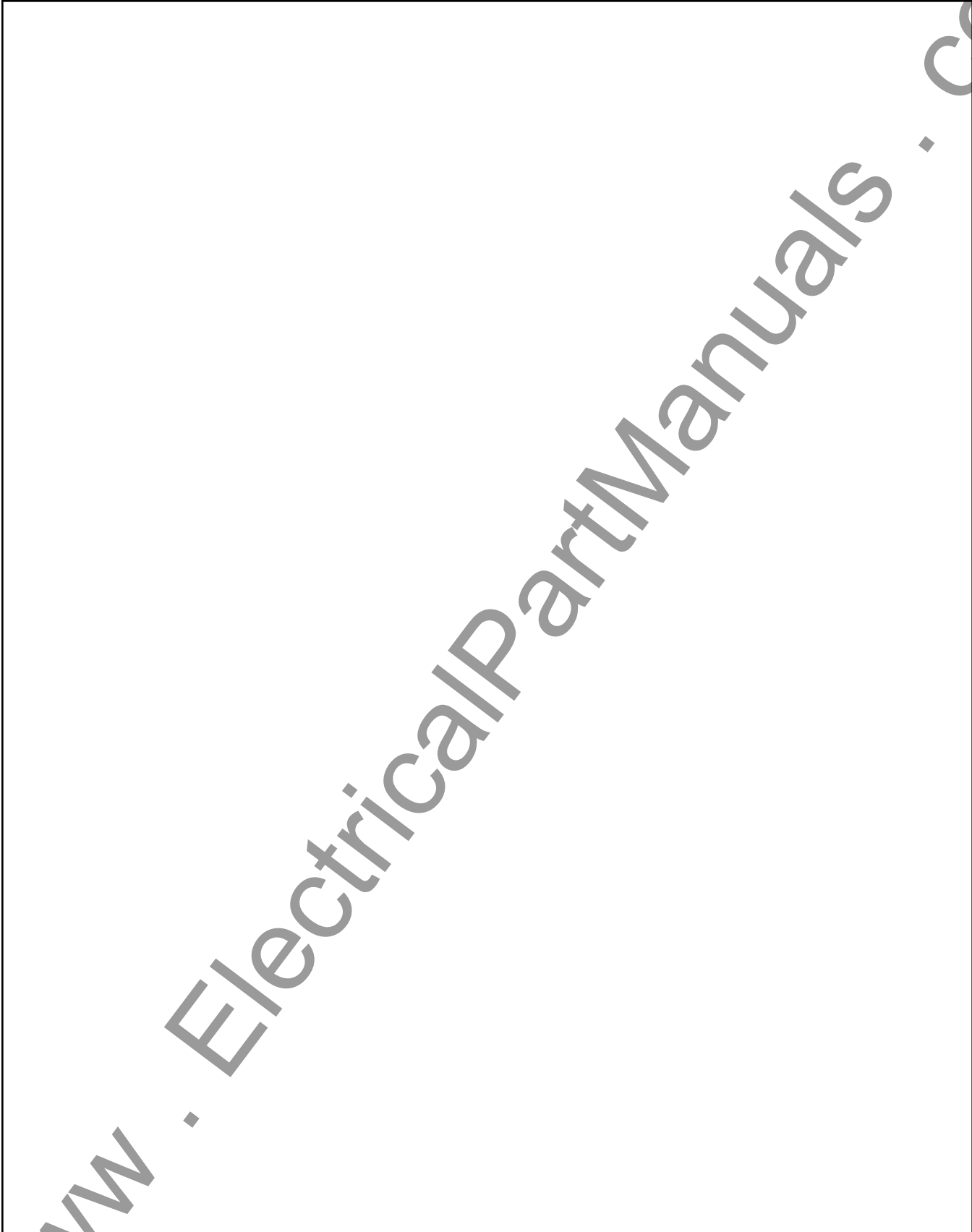

Figure 7.11 IEC C Curves

Below are the 565 Timed Overcurrent Curve Equations. Overload values from 1.03 to 20.0 times pickup and Time Dials from 1 to 32 may be entered into these equations.

MODERATELY INVERSE

$$\text{Trip Time} = \left[525 + \frac{3121}{(\text{Overload} - 0.8)} \right] \times \left[\frac{0.1 + (3 - 0.1) \times \left(\frac{\text{Time Dial} - 1}{31} \right)}{525 + \frac{3121}{(20 - 0.8)}} \right]$$

NORMALLY INVERSE

$$\text{Trip Time} = \left[478 + \frac{3245.7}{(\text{Overload} - 1)} \right] \times \left[\frac{0.046 + (2.788 - 0.046) \times \left(\frac{\text{Time Dial} - 1}{31} \right)}{478 + \frac{3245.7}{(20 - 1)}} \right]$$

VERY INVERSE

$$\text{Trip Time} = \left[310 + \frac{20415}{(\text{Overload} - 1)} \right] \times \left[\frac{0.027 + (1.368 - 0.027) \times \left(\frac{\text{Time Dial} - 1}{31} \right)}{310 + \frac{20415}{(20 - 1)}} \right]$$

EXTREMELY INVERSE

$$\text{Trip Time} = \left[110 + \frac{17640}{(\text{Overload} - 0.5)^2} \right] \times \left[\frac{0.03 + (0.5 - 0.03) \times \left(\frac{\text{Time Dial} - 1}{31} \right)}{110 + \frac{17640}{(20 - 0.5)^2}} \right]$$

The preceding four equations, and the three IEC equations, represent the theoretical trip times for the 565 and not the actual trip times. This is because the relay uses look up tables where a 16 bit number (0-65,535) is stored. This number represents the number of trips per 65,535 cycles or 1092.25 seconds. The relay does not store the theoretical trip times in memory and as a result there are rounding off errors. The following will simulate how the relay operates. By performing these operations on the theoretical trip times, you can calculate the exact 565 trip times for various overload levels and time dials. First of all, calculate the number of trips per 65,535 cycles. This is based on the theoretical trip time.

$$\text{Number of trips per 65,535 cycles} = \frac{1092.25 \text{ seconds}}{\text{Theoretical Trip Time}}$$

Since only integer numbers can be stored in the 565 look up tables, this value must be rounded off. Working backwards with this rounded off value, the number of cycles before a trip occurs can be calculated.

$$\text{Number of cycles per trip} = \frac{65,535}{\# \text{ trips per 65,535 cycles}}$$

Finally, the actual trip time would be based on this number of

cycles.

$$\text{Actual Trip Time} = \frac{\text{Number of cycles per trip}}{60}$$

EXAMPLE:

Extremely Inverse
Overload Level = 3.0 x pickup
Time Dial = 4

Theoretical Trip Time = 1.415 seconds.

$$\begin{aligned} \text{Number of trips per 65,535 cycles} &= \frac{1092.25 \text{ seconds}}{\text{Theoretical Trip Time}} \\ &= \frac{1092.25 \text{ seconds}}{1.415 \text{ seconds}} \\ &= 771.91 \end{aligned}$$

This value is then rounded off to 2 and stored in the relay's memory. Working backwards...

$$\begin{aligned} \text{Number of cycles per trip} &= \frac{65,535}{\text{Number of trips per 65,535 cycles}} \\ &= \frac{65,535}{771} \end{aligned}$$

Now in terms of time:

$$\begin{aligned} \text{Actual Trip Time} &= \frac{\text{Number of cycles per trip}}{60} \\ &= \frac{85}{60} \\ &= 1.417 \text{ seconds} \end{aligned}$$

IEC CURVES

Three new curve shapes, IEC A, IEC B, and IEC C, are now present in addition to the standard Moderately Inverse, Normally Inverse, Very Inverse, and Extremely Inverse shapes. The formulas below characterize the IEC curve shapes.

$$\text{IEC A: } t = \frac{0.14}{\left[\frac{\text{Actual Current}}{\text{Pickup Current}} \right]^{0.02} - 1} \times \text{Multiplier}$$

$$\text{IEC B: } t = \frac{13.5}{\left[\frac{\text{Actual Current}}{\text{Pickup Current}} \right] - 1} \times \text{Multiplier}$$

$$\text{IEC C: } t = \frac{80.0}{\left[\frac{\text{Actual Current}}{\text{Pickup Current}} \right]^2 - 1} \times \text{Multiplier}$$

Once the curve shape is chosen, one of the 32 time dials for that shape should be selected. The relationship between the

CURVE INFORMATION AND TABLES



multiplier in the formula and the selected time dial is as follows:

$$\text{Multiplier} = \frac{\text{Time Dial}}{20}$$

The additional overcurrent curve shapes are selectable with Modbus protocol communications. The following memory map registers reflect this change.

Address	Dec	Hex	Chapter	Page	Line	Unit	Type of data
261	0105		SETPOINTS	PHASE CURRENT	PHASE O/C CURVE SHAPE		Unsigned
261	*	***	****		0: MOD INV		
261	*	***	****		1: NORMAL INV		
261	*	***	****		2: VERY INV		
261	*	***	****		3: EXTREM INV		
261	*	***	****		4: CUSTOM		
261	*	***	****		5: IEC A		
261	*	***	****		6: IEC B		
261	*	***	****		7: IEC C		
303	012F		SETPOINTS	GROUND CURRENT	GND O/C CURVE SHAPE		Unsigned
303	*	***	****		0: MOD INV		
303	*	***	****		1: NORMAL INV		
303	*	***	****		2: VERY INV		
303	*	***	****		3: EXTREM INV		
303	*	***	****		4: CUSTOM		
303	*	***	****		5: IEC A		
303	*	***	****		6: IEC B		
303	*	***	****		7: IEC C		

On the following pages are the curve tables for the ANSI curves Moderately Inverse, Normal Inverse, Very Inverse, and Extremely Inverse.

CURVE INFORMATION AND TABLES



Curve: Normal Inverse

Curve#:	1	2	3	4	5	6	7	8	9	10	11	12	13	14	15	16
× P/U	Time to trip (seconds)															
1.03	7.692	22.291	37.664	52.012	68.266	84.019	99.295	109.225	121.361	136.531	156.036	182.042	182.042	218.450	218.450	218.450
1.10	2.334	6.827	11.260	15.830	20.227	24.824	29.520	34.133	37.664	42.010	47.489	52.012	57.487	60.681	64.250	68.266
1.20	1.185	3.467	5.749	8.031	10.304	12.555	14.760	17.066	19.504	21.845	23.745	26.006	28.743	31.207	33.098	35.234
1.30	0.801	2.339	3.887	5.434	6.957	8.533	10.021	11.620	13.160	14.760	16.302	17.617	19.162	21.005	22.291	23.745
1.40	0.609	1.782	2.952	4.122	5.302	6.463	7.638	8.808	10.021	11.145	12.272	13.485	14.760	15.830	17.066	18.204
1.50	0.494	1.445	2.395	3.340	4.300	5.251	6.206	7.139	8.091	9.027	10.021	10.923	11.872	12.850	13.826	14.760
1.60	0.417	1.220	2.023	2.822	3.629	4.422	5.226	6.035	6.827	7.638	8.467	9.256	10.021	10.814	11.620	12.412
1.70	0.363	1.059	1.756	2.454	3.148	3.846	4.551	5.251	5.936	6.620	7.331	8.031	8.738	9.416	10.113	10.814
1.80	0.322	0.940	1.558	2.176	2.793	3.413	4.030	4.648	5.277	5.872	6.501	7.139	7.746	8.338	8.953	9.581
1.90	0.290	0.846	1.404	1.961	2.517	3.077	3.629	4.185	4.749	5.302	5.872	6.425	6.957	7.533	8.091	8.669
2.00	0.264	0.772	1.279	1.788	2.295	2.801	3.310	3.819	4.317	4.833	5.328	5.841	6.350	6.869	7.380	7.858
2.10	0.243	0.711	1.178	1.645	2.113	2.582	3.051	3.512	3.986	4.458	4.920	5.381	5.841	6.314	6.784	7.233
2.20	0.226	0.660	1.093	1.528	1.961	2.395	2.830	3.260	3.703	4.137	4.570	4.987	5.434	5.872	6.314	6.742
2.30	0.211	0.616	1.022	1.428	1.833	2.238	2.645	3.051	3.456	3.860	4.267	4.668	5.080	5.489	5.904	6.277
2.40	0.198	0.579	0.961	1.342	1.723	2.105	2.488	2.867	3.251	3.629	4.016	4.387	4.770	5.152	5.544	5.904
2.50	0.187	0.547	0.908	1.267	1.628	1.990	2.349	2.710	3.068	3.424	3.793	4.153	4.513	4.876	5.226	5.601
2.60	0.178	0.519	0.861	1.203	1.545	1.886	2.229	2.570	2.913	3.251	3.593	3.943	4.283	4.628	4.965	5.302
2.70	0.169	0.495	0.820	1.146	1.470	1.796	2.121	2.449	2.772	3.094	3.424	3.753	4.076	4.404	4.728	5.057
2.80	0.162	0.473	0.784	1.094	1.406	1.717	2.026	2.339	2.651	2.960	3.270	3.581	3.887	4.201	4.513	4.833
2.90	0.155	0.453	0.751	1.049	1.347	1.645	1.944	2.243	2.540	2.837	3.139	3.435	3.728	4.030	4.334	4.628
3.00	0.149	0.435	0.722	1.009	1.294	1.581	1.867	2.154	2.438	2.724	3.009	3.300	3.581	3.873	4.153	4.440
3.10	0.143	0.419	0.695	0.971	1.247	1.523	1.799	2.073	2.349	2.626	2.905	3.175	3.456	3.728	4.001	4.283
3.20	0.138	0.405	0.671	0.938	1.204	1.470	1.736	2.004	2.271	2.534	2.801	3.068	3.330	3.605	3.873	4.137
3.30	0.134	0.391	0.649	0.906	1.164	1.422	1.680	1.937	2.193	2.454	2.710	2.968	3.222	3.479	3.741	4.001
3.40	0.130	0.379	0.629	0.878	1.128	1.377	1.628	1.877	2.125	2.374	2.626	2.874	3.121	3.371	3.629	3.873
3.50	0.126	0.368	0.610	0.853	1.094	1.337	1.578	1.820	2.065	2.304	2.546	2.786	3.034	3.270	3.512	3.753
3.60	0.122	0.358	0.593	0.829	1.064	1.299	1.534	1.770	2.004	2.238	2.477	2.710	2.944	3.184	3.413	3.653
3.70	0.119	0.348	0.577	0.806	1.035	1.264	1.494	1.723	1.950	2.180	2.411	2.638	2.867	3.094	3.330	3.558
3.80	0.116	0.339	0.562	0.786	1.009	1.231	1.454	1.678	1.903	2.125	2.349	2.570	2.793	3.017	3.241	3.467
3.90	0.113	0.331	0.549	0.766	0.984	1.202	1.420	1.638	1.854	2.073	2.290	2.511	2.724	2.944	3.166	3.382
4.00	0.111	0.323	0.536	0.749	0.961	1.174	1.386	1.599	1.811	2.023	2.238	2.449	2.664	2.874	3.085	3.300
4.10	0.108	0.316	0.524	0.732	0.940	1.147	1.355	1.563	1.770	1.979	2.189	2.395	2.601	2.808	3.017	3.222
4.20	0.106	0.309	0.513	0.716	0.919	1.123	1.327	1.530	1.734	1.937	2.142	2.344	2.546	2.751	2.952	3.157
4.30	0.104	0.303	0.502	0.702	0.900	1.100	1.299	1.498	1.699	1.896	2.096	2.295	2.494	2.697	2.890	3.094
4.40	0.102	0.297	0.492	0.687	0.883	1.078	1.273	1.468	1.665	1.861	2.053	2.252	2.444	2.638	2.837	3.034
4.50	0.100	0.291	0.483	0.674	0.866	1.057	1.250	1.441	1.633	1.823	2.015	2.207	2.401	2.588	2.779	2.976
4.60	0.098	0.286	0.474	0.662	0.850	1.038	1.226	1.415	1.602	1.791	1.979	2.167	2.354	2.540	2.731	2.920
4.70	0.096	0.281	0.466	0.650	0.835	1.020	1.204	1.390	1.574	1.759	1.944	2.129	2.314	2.499	2.684	2.867
4.80	0.094	0.276	0.458	0.639	0.821	1.002	1.185	1.365	1.547	1.728	1.910	2.092	2.276	2.454	2.638	2.815
4.90	0.093	0.272	0.450	0.629	0.807	0.986	1.164	1.343	1.521	1.701	1.880	2.057	2.238	2.416	2.594	2.772
5.00	0.091	0.267	0.443	0.619	0.794	0.970	1.146	1.322	1.498	1.673	1.848	2.026	2.202	2.374	2.552	2.731
5.10	0.090	0.263	0.436	0.609	0.782	0.956	1.128	1.302	1.474	1.647	1.820	1.993	2.167	2.339	2.511	2.684
5.20	0.089	0.259	0.430	0.600	0.771	0.942	1.112	1.282	1.452	1.623	1.794	1.964	2.133	2.304	2.477	2.645
5.30	0.087	0.255	0.424	0.592	0.760	0.928	1.096	1.264	1.432	1.599	1.767	1.937	2.105	2.271	2.438	2.607
5.40	0.086	0.252	0.418	0.583	0.749	0.915	1.080	1.247	1.411	1.578	1.745	1.910	2.077	2.243	2.406	2.570
5.50	0.085	0.249	0.412	0.575	0.739	0.903	1.066	1.230	1.393	1.556	1.720	1.883	2.045	2.211	2.374	2.540
5.60	0.084	0.245	0.407	0.568	0.729	0.891	1.052	1.214	1.374	1.536	1.699	1.858	2.019	2.180	2.344	2.505
5.70	0.083	0.242	0.401	0.561	0.720	0.879	1.038	1.198	1.357	1.517	1.675	1.836	1.993	2.154	2.314	2.471
5.80	0.082	0.239	0.396	0.554	0.711	0.868	1.026	1.183	1.340	1.498	1.655	1.811	1.972	2.129	2.285	2.444
5.90	0.081	0.236	0.392	0.547	0.703	0.858	1.013	1.169	1.324	1.480	1.635	1.791	1.947	2.100	2.257	2.411
6.00	0.080	0.234	0.387	0.541	0.694	0.848	1.002	1.156	1.310	1.462	1.616	1.770	1.923	2.077	2.229	2.385
6.50	0.076	0.221	0.367	0.513	0.658	0.804	0.950	1.096	1.241	1.386	1.532	1.678	1.823	1.968	2.113	2.261
7.00	0.072	0.211	0.350	0.489	0.628	0.767	0.906	1.044	1.183	1.322	1.462	1.599	1.739	1.877	2.015	2.154
7.50	0.069	0.203	0.336	0.469	0.602	0.736	0.869	1.002	1.135	1.269	1.402	1.534	1.668	1.802	1.933	2.069
8.00	0.067	0.195	0.324	0.452	0.580	0.709	0.837	0.966	1.093	1.222	1.350	1.478	1.606	1.736	1.864	1.993
8.50	0.065	0.189	0.313	0.437	0.561	0.685	0.810	0.934	1.057	1.182	1.307	1.430	1.554	1.678	1.802	1.926
9.00	0.063	0.183	0.304	0.424	0.544	0.665	0.785	0.906	1.027	1.147	1.267	1.388	1.509	1.628	1.750	1.870

Curve: Normal Inverse

Curve#:	1	2	3	4	5	6	7	8	9	10	11	12	13	14	15	16
x P/U																
	Time to trip (seconds)															
9.50	0.061	0.178	0.295	0.413	0.530	0.647	0.764	0.882	0.998	1.116	1.233	1.350	1.468	1.585	1.701	1.820
10.00	0.059	0.174	0.288	0.402	0.517	0.631	0.746	0.860	0.974	1.088	1.203	1.318	1.432	1.545	1.660	1.773
10.50	0.058	0.170	0.282	0.393	0.505	0.617	0.729	0.840	0.952	1.064	1.176	1.287	1.399	1.511	1.623	1.734
11.00	0.057	0.166	0.276	0.385	0.494	0.604	0.713	0.822	0.932	1.041	1.151	1.260	1.370	1.480	1.588	1.699
11.50	0.056	0.163	0.270	0.378	0.485	0.592	0.700	0.807	0.914	1.022	1.128	1.236	1.343	1.451	1.558	1.665
12.00	0.055	0.160	0.266	0.371	0.476	0.582	0.687	0.793	0.898	1.003	1.109	1.214	1.319	1.424	1.530	1.635
12.50	0.054	0.158	0.261	0.365	0.468	0.572	0.676	0.780	0.883	0.987	1.090	1.194	1.297	1.400	1.504	1.609
13.00	0.053	0.155	0.257	0.359	0.461	0.563	0.665	0.768	0.870	0.972	1.073	1.176	1.277	1.379	1.482	1.583
13.50	0.052	0.153	0.253	0.354	0.455	0.555	0.656	0.756	0.857	0.957	1.058	1.158	1.258	1.360	1.460	1.560
14.00	0.052	0.151	0.250	0.349	0.448	0.547	0.647	0.746	0.845	0.944	1.043	1.143	1.243	1.342	1.441	1.541
14.50	0.051	0.149	0.247	0.345	0.443	0.541	0.639	0.737	0.834	0.933	1.030	1.128	1.226	1.324	1.422	1.519
15.00	0.050	0.147	0.244	0.341	0.437	0.534	0.631	0.728	0.824	0.921	1.018	1.115	1.211	1.308	1.406	1.502
15.50	0.050	0.145	0.241	0.337	0.432	0.528	0.624	0.720	0.815	0.911	1.007	1.102	1.198	1.294	1.390	1.484
16.00	0.049	0.144	0.239	0.333	0.428	0.523	0.617	0.712	0.807	0.901	0.996	1.090	1.185	1.280	1.374	1.470
16.50	0.049	0.142	0.236	0.330	0.424	0.517	0.611	0.705	0.798	0.892	0.986	1.079	1.173	1.267	1.360	1.454
17.00	0.048	0.141	0.234	0.327	0.420	0.512	0.605	0.698	0.791	0.884	0.976	1.070	1.162	1.255	1.348	1.441
17.50	0.048	0.140	0.232	0.324	0.416	0.508	0.600	0.692	0.784	0.876	0.967	1.059	1.152	1.244	1.335	1.428
18.00	0.047	0.139	0.230	0.321	0.412	0.503	0.595	0.686	0.777	0.868	0.959	1.050	1.141	1.233	1.324	1.415
18.50	0.047	0.137	0.228	0.318	0.409	0.499	0.590	0.680	0.771	0.861	0.951	1.042	1.132	1.223	1.313	1.404
19.00	0.047	0.136	0.226	0.316	0.406	0.495	0.585	0.675	0.765	0.855	0.944	1.034	1.124	1.214	1.303	1.393
19.50	0.046	0.135	0.225	0.314	0.403	0.492	0.581	0.670	0.759	0.848	0.937	1.027	1.116	1.204	1.294	1.383
20.00	0.046	0.134	0.223	0.311	0.400	0.488	0.577	0.665	0.754	0.842	0.930	1.019	1.108	1.196	1.285	1.372

www.ElectricalPanel.com

CURVE INFORMATION AND TABLES



Curve: Normal Inverse

Curve#:	17	18	19	20	21	22	23	24	25	26	27	28	29	30	31	32
× P/U	Time to trip (seconds)															
1.03	273.063	273.063	273.063	273.063	273.063	364.083	364.083	364.083	364.083	364.083	364.083	364.083	364.083	546.125	546.125	546.125
1.10	72.817	78.018	84.019	91.021	91.021	99.295	99.295	109.225	109.225	109.225	121.361	121.361	121.361	136.531	136.531	136.531
1.20	37.664	40.454	42.010	43.690	47.489	49.648	52.012	54.613	54.613	57.487	60.681	64.250	64.250	68.266	68.266	72.817
1.30	25.401	27.306	28.743	30.340	31.207	33.098	35.234	36.408	37.664	39.009	40.454	42.010	43.690	45.510	47.489	47.489
1.40	19.504	20.608	21.845	22.755	24.272	25.401	26.640	27.306	28.743	29.520	31.207	32.125	33.098	34.133	35.234	36.408
1.50	15.604	16.549	17.617	18.513	19.504	20.608	21.417	22.291	23.239	24.272	25.401	26.006	27.306	28.006	28.743	30.340
1.60	13.320	14.003	14.962	15.604	16.549	17.337	18.204	18.832	19.859	20.608	21.417	22.291	22.755	23.745	24.272	25.401
1.70	11.497	12.272	12.850	13.653	14.372	14.962	15.604	16.302	17.066	17.906	18.513	19.162	19.859	20.608	21.417	21.845
1.80	10.208	10.814	11.497	12.003	12.701	13.320	14.003	14.563	15.170	15.830	16.302	17.066	17.617	18.204	18.832	19.504
1.90	9.179	9.752	10.304	10.923	11.378	12.003	12.555	13.160	13.653	14.185	14.760	15.384	15.830	16.549	17.066	17.617
2.00	8.402	8.880	9.416	9.930	10.402	10.923	11.378	12.003	12.412	13.003	13.485	14.003	14.563	14.962	15.604	16.063
2.10	7.746	8.212	8.669	9.102	9.581	10.021	10.502	11.033	11.497	11.872	12.412	12.850	13.320	13.826	14.185	14.760
2.20	7.186	7.585	8.031	8.467	8.880	9.335	9.752	10.208	10.604	11.033	11.497	12.003	12.412	12.850	13.320	13.653
2.30	6.701	7.093	7.533	7.915	8.338	8.738	9.102	9.498	9.930	10.304	10.708	11.145	11.620	12.003	12.412	12.850
2.40	6.314	6.660	7.047	7.430	7.802	8.212	8.600	8.953	9.335	9.752	10.113	10.502	10.923	11.260	11.620	12.003
2.50	5.936	6.314	6.660	7.047	7.380	7.746	8.091	8.467	8.808	9.179	9.581	9.930	10.304	10.604	11.033	11.378
2.60	5.659	6.001	6.314	6.660	7.002	7.331	7.692	8.031	8.402	8.738	9.027	9.416	9.752	10.113	10.402	10.814
2.70	5.381	5.689	6.035	6.350	6.660	7.002	7.331	7.638	7.973	8.275	8.600	8.953	9.256	9.581	9.930	10.304
2.80	5.128	5.461	5.749	6.068	6.387	6.701	7.002	7.331	7.638	7.915	8.275	8.533	8.880	9.179	9.498	9.840
2.90	4.920	5.226	5.516	5.810	6.102	6.425	6.701	7.002	7.331	7.585	7.915	8.212	8.533	8.808	9.102	9.416
3.00	4.728	5.010	5.302	5.601	5.872	6.171	6.463	6.742	7.002	7.331	7.585	7.858	8.151	8.467	8.738	9.027
3.10	4.551	4.833	5.104	5.381	5.659	5.936	6.206	6.501	6.784	7.047	7.331	7.585	7.858	8.151	8.402	8.669
3.20	4.404	4.668	4.942	5.201	5.461	5.719	6.001	6.277	6.540	6.784	7.047	7.331	7.585	7.858	8.151	8.402
3.30	4.250	4.513	4.770	5.033	5.277	5.544	5.810	6.068	6.314	6.580	6.827	7.093	7.331	7.585	7.858	8.091
3.40	4.122	4.369	4.628	4.876	5.128	5.381	5.630	5.872	6.102	6.350	6.620	6.869	7.139	7.380	7.638	7.858
3.50	4.001	4.250	4.476	4.728	4.965	5.201	5.461	5.689	5.936	6.171	6.425	6.660	6.913	7.139	7.380	7.638
3.60	3.887	4.122	4.352	4.589	4.833	5.057	5.302	5.544	5.779	6.001	6.241	6.463	6.701	6.957	7.186	7.430
3.70	3.779	4.016	4.250	4.476	4.708	4.920	5.152	5.381	5.630	5.841	6.068	6.314	6.540	6.742	7.002	7.233
3.80	3.690	3.915	4.137	4.352	4.589	4.812	5.033	5.251	5.461	5.689	5.904	6.136	6.350	6.580	6.827	7.047
3.90	3.593	3.819	4.030	4.250	4.476	4.688	4.898	5.128	5.328	5.544	5.779	6.001	6.206	6.425	6.660	6.869
4.00	3.512	3.728	3.943	4.153	4.369	4.570	4.791	5.010	5.226	5.434	5.630	5.841	6.068	6.277	6.501	6.701
4.10	3.435	3.641	3.846	4.060	4.267	4.476	4.688	4.898	5.104	5.302	5.516	5.719	5.936	6.136	6.350	6.540
4.20	3.361	3.569	3.766	3.972	4.169	4.387	4.589	4.791	4.987	5.201	5.407	5.601	5.810	6.001	6.206	6.425
4.30	3.290	3.490	3.690	3.887	4.091	4.283	4.495	4.688	4.876	5.080	5.277	5.489	5.689	5.872	6.068	6.277
4.40	3.222	3.424	3.617	3.806	4.001	4.201	4.404	4.589	4.791	4.987	5.177	5.381	5.573	5.779	5.969	6.171
4.50	3.166	3.361	3.546	3.741	3.929	4.122	4.317	4.513	4.688	4.898	5.080	5.277	5.461	5.659	5.841	6.035
4.60	3.103	3.300	3.479	3.665	3.860	4.045	4.234	4.422	4.609	4.791	4.987	5.177	5.354	5.544	5.749	5.936
4.70	3.051	3.241	3.424	3.605	3.793	3.972	4.153	4.352	4.532	4.708	4.898	5.080	5.277	5.461	5.630	5.810
4.80	3.001	3.184	3.361	3.546	3.728	3.915	4.091	4.267	4.458	4.628	4.812	4.987	5.177	5.354	5.544	5.719
4.90	2.952	3.130	3.310	3.490	3.665	3.846	4.016	4.201	4.387	4.551	4.728	4.920	5.104	5.277	5.461	5.630
5.00	2.905	3.077	3.251	3.435	3.605	3.779	3.957	4.137	4.317	4.495	4.668	4.833	5.010	5.201	5.354	5.544
5.10	2.859	3.034	3.203	3.382	3.546	3.728	3.901	4.076	4.250	4.422	4.589	4.770	4.942	5.104	5.277	5.461
5.20	2.815	2.984	3.157	3.330	3.501	3.665	3.846	4.016	4.185	4.352	4.513	4.688	4.854	5.033	5.201	5.381
5.30	2.779	2.944	3.112	3.280	3.446	3.617	3.779	3.957	4.122	4.283	4.458	4.628	4.791	4.965	5.128	5.302
5.40	2.737	2.905	3.068	3.232	3.403	3.569	3.728	3.901	4.060	4.234	4.387	4.570	4.728	4.898	5.057	5.226
5.50	2.704	2.867	3.026	3.194	3.350	3.523	3.678	3.846	4.016	4.169	4.334	4.495	4.668	4.833	4.987	5.152
5.60	2.664	2.830	2.984	3.148	3.310	3.467	3.629	3.793	3.957	4.122	4.283	4.440	4.609	4.770	4.920	5.080
5.70	2.632	2.793	2.952	3.112	3.270	3.424	3.593	3.741	3.901	4.060	4.217	4.387	4.551	4.708	4.854	5.010
5.80	2.601	2.758	2.913	3.068	3.222	3.382	3.546	3.703	3.860	4.016	4.169	4.334	4.495	4.648	4.812	4.965
5.90	2.570	2.724	2.882	3.034	3.194	3.350	3.501	3.653	3.806	3.972	4.122	4.283	4.440	4.589	4.749	4.898
6.00	2.540	2.690	2.844	3.001	3.157	3.310	3.456	3.617	3.766	3.915	4.076	4.234	4.387	4.532	4.688	4.833
6.50	2.406	2.552	2.697	2.844	2.984	3.130	3.280	3.424	3.569	3.715	3.860	4.001	4.153	4.300	4.440	4.589
7.00	2.295	2.433	2.570	2.710	2.852	2.992	3.130	3.270	3.403	3.546	3.690	3.819	3.957	4.106	4.234	4.387
7.50	2.202	2.334	2.466	2.601	2.731	2.867	3.001	3.130	3.270	3.403	3.535	3.665	3.806	3.929	4.060	4.201
8.00	2.121	2.247	2.380	2.505	2.632	2.765	2.890	3.017	3.148	3.280	3.403	3.535	3.665	3.793	3.915	4.045
8.50	2.049	2.176	2.299	2.422	2.546	2.671	2.793	2.920	3.042	3.166	3.290	3.413	3.546	3.665	3.793	3.915
9.00	1.990	2.113	2.229	2.354	2.471	2.594	2.710	2.837	2.952	3.077	3.194	3.320	3.435	3.558	3.678	3.793
9.50	1.937	2.053	2.171	2.290	2.406	2.523	2.638	2.758	2.874	2.992	3.112	3.222	3.340	3.456	3.581	3.690
10.00	1.890	2.004	2.117	2.234	2.344	2.460	2.576	2.690	2.801	2.920	3.034	3.148	3.260	3.371	3.490	3.605
10.50	1.845	1.957	2.069	2.180	2.295	2.406	2.517	2.626	2.737	2.852	2.960	3.077	3.184	3.300	3.413	3.523
11.00	1.808	1.916	2.026	2.137	2.243	2.354	2.466	2.576	2.684	2.793	2.905	3.009	3.121	3.232	3.340	3.446
11.50	1.773	1.880	1.986	2.096	2.202	2.309	2.416	2.523	2.632	2.737	2.844	2.952	3.060	3.166	3.270	3.382
12.00	1.742	1.845	1.950	2.057	2.163	2.266	2.374	2.477	2.582	2.690	2.793	2.897	3.009	3.112	3.213	3.320
12.50	1.712	1.814	1.920	2.023	2.125	2.229	2.334	2.438	2.540	2.645	2.751	2.852	2.952	3.060	3.166	3.270

Curve: Normal Inverse

Curve#:	17	18	19	20	21	22	23	24	25	26	27	28	29	30	31	32		
× P/U								Time to trip (seconds)										
13.00	1.686	1.788	1.890	1.993	2.092	2.198	2.299	2.401	2.499	2.607	2.704	2.808	2.913	3.009	3.112	3.213		
13.50	1.662	1.762	1.864	1.964	2.065	2.163	2.266	2.364	2.466	2.564	2.664	2.765	2.867	2.968	3.068	3.166		
14.00	1.640	1.739	1.836	1.937	2.034	2.133	2.234	2.334	2.433	2.534	2.632	2.731	2.830	2.928	3.026	3.130		
14.50	1.618	1.715	1.814	1.913	2.012	2.109	2.207	2.304	2.401	2.499	2.594	2.697	2.793	2.890	2.992	3.085		
15.00	1.599	1.696	1.794	1.890	1.986	2.084	2.180	2.276	2.374	2.471	2.564	2.664	2.758	2.859	2.952	3.051		
15.50	1.581	1.675	1.773	1.867	1.964	2.061	2.154	2.252	2.344	2.444	2.540	2.632	2.731	2.822	2.920	3.017		
16.00	1.565	1.657	1.753	1.848	1.944	2.038	2.133	2.225	2.319	2.416	2.511	2.607	2.697	2.793	2.890	2.984		
16.50	1.547	1.642	1.736	1.830	1.923	2.015	2.109	2.202	2.299	2.390	2.482	2.576	2.671	2.765	2.859	2.952		
17.00	1.534	1.625	1.720	1.811	1.906	1.997	2.088	2.185	2.276	2.369	2.460	2.552	2.645	2.737	2.830	2.928		
17.50	1.519	1.611	1.704	1.796	1.886	1.979	2.073	2.163	2.257	2.349	2.438	2.534	2.626	2.717	2.808	2.897		
18.00	1.507	1.597	1.688	1.779	1.870	1.961	2.053	2.146	2.238	2.329	2.416	2.511	2.601	2.690	2.786	2.874		
18.50	1.494	1.585	1.675	1.765	1.858	1.947	2.038	2.129	2.220	2.309	2.401	2.488	2.582	2.671	2.758	2.852		
19.00	1.482	1.572	1.662	1.753	1.842	1.930	2.023	2.113	2.202	2.290	2.380	2.471	2.558	2.651	2.737	2.830		
19.50	1.472	1.560	1.650	1.739	1.827	1.916	2.008	2.096	2.185	2.276	2.364	2.449	2.540	2.632	2.717	2.808		
20.00	1.462	1.549	1.638	1.726	1.814	1.903	1.993	2.080	2.167	2.257	2.344	2.433	2.523	2.613	2.697	2.786		

www.ElectricalPartMan.com

CURVE INFORMATION AND TABLES



Curve: Moderately Inverse

Curve#:	1	2	3	4	5	6	7	8	9	10	11	12	13	14	15	16
× P/U	Time to trip (seconds)															
1.03	2.049	3.972	5.872	7.802	9.752	11.620	13.485	15.384	17.337	19.162	21.417	23.239	24.824	27.306	28.743	31.207
1.10	1.590	3.077	4.570	6.035	7.533	9.027	10.502	12.003	13.485	14.962	16.549	17.906	19.504	21.005	22.291	23.745
1.20	1.211	2.344	3.479	4.609	5.749	6.869	8.031	9.179	10.304	11.378	12.555	13.653	14.760	15.830	17.066	18.204
1.30	0.984	1.906	2.822	3.741	4.668	5.601	6.501	7.430	8.338	9.256	10.208	11.145	12.003	13.003	13.826	14.760
1.40	0.833	1.611	2.390	3.166	3.943	4.728	5.516	6.277	7.047	7.858	8.600	9.416	10.208	10.923	11.745	12.555
1.50	0.725	1.402	2.080	2.758	3.435	4.122	4.791	5.461	6.136	6.827	7.481	8.212	8.880	9.581	10.208	10.923
1.60	0.644	1.245	1.848	2.449	3.051	3.653	4.250	4.854	5.461	6.068	6.660	7.282	7.858	8.467	9.102	9.666
1.70	0.581	1.124	1.668	2.211	2.751	3.300	3.846	4.387	4.920	5.461	6.001	6.540	7.093	7.638	8.212	8.738
1.80	0.530	1.027	1.523	2.019	2.517	3.009	3.512	4.001	4.495	4.987	5.489	6.001	6.501	7.002	7.481	7.973
1.90	0.489	0.946	1.404	1.861	2.319	2.779	3.232	3.690	4.153	4.609	5.057	5.516	5.969	6.425	6.913	7.331
2.00	0.455	0.880	1.305	1.731	2.154	2.582	3.009	3.435	3.860	4.283	4.708	5.128	5.544	5.969	6.425	6.827
2.10	0.425	0.824	1.222	1.621	2.019	2.416	2.815	3.213	3.605	4.016	4.404	4.812	5.201	5.601	6.001	6.387
2.20	0.401	0.775	1.150	1.525	1.900	2.276	2.651	3.026	3.403	3.779	4.153	4.532	4.898	5.277	5.659	6.035
2.30	0.379	0.734	1.088	1.443	1.796	2.150	2.505	2.859	3.213	3.569	3.929	4.283	4.628	4.987	5.354	5.689
2.40	0.360	0.697	1.033	1.370	1.707	2.045	2.380	2.717	3.051	3.392	3.728	4.060	4.404	4.749	5.080	5.407
2.50	0.343	0.665	0.986	1.307	1.628	1.950	2.271	2.594	2.913	3.232	3.558	3.873	4.201	4.513	4.833	5.152
2.60	0.328	0.636	0.943	1.251	1.558	1.864	2.171	2.482	2.786	3.094	3.403	3.715	4.016	4.317	4.628	4.942
2.70	0.315	0.610	0.905	1.200	1.494	1.791	2.084	2.380	2.677	2.968	3.260	3.558	3.860	4.153	4.440	4.749
2.80	0.303	0.587	0.871	1.155	1.439	1.723	2.004	2.290	2.576	2.859	3.139	3.424	3.703	3.986	4.283	4.551
2.90	0.293	0.566	0.840	1.113	1.388	1.660	1.933	2.207	2.482	2.758	3.026	3.300	3.581	3.846	4.122	4.404
3.00	0.283	0.547	0.811	1.076	1.340	1.604	1.870	2.133	2.401	2.664	2.928	3.194	3.456	3.715	3.986	4.250
3.10	0.274	0.530	0.786	1.042	1.297	1.554	1.811	2.065	2.324	2.576	2.837	3.094	3.350	3.605	3.860	4.122
3.20	0.265	0.514	0.762	1.010	1.258	1.507	1.756	2.004	2.252	2.499	2.751	3.001	3.241	3.490	3.741	3.986
3.30	0.258	0.499	0.741	0.981	1.223	1.464	1.707	1.947	2.189	2.427	2.671	2.913	3.157	3.392	3.641	3.873
3.40	0.251	0.486	0.720	0.956	1.190	1.424	1.660	1.893	2.129	2.364	2.601	2.830	3.068	3.300	3.535	3.766
3.50	0.244	0.473	0.702	0.930	1.160	1.388	1.616	1.845	2.073	2.304	2.534	2.758	2.992	3.222	3.446	3.678
3.60	0.238	0.462	0.685	0.908	1.131	1.353	1.576	1.799	2.023	2.247	2.471	2.690	2.913	3.139	3.361	3.581
3.70	0.233	0.451	0.668	0.887	1.104	1.322	1.541	1.759	1.975	2.193	2.411	2.632	2.844	3.068	3.280	3.501
3.80	0.228	0.441	0.654	0.867	1.079	1.293	1.507	1.717	1.933	2.146	2.359	2.570	2.786	2.992	3.213	3.424
3.90	0.223	0.431	0.639	0.848	1.056	1.264	1.474	1.683	1.890	2.100	2.309	2.517	2.724	2.928	3.139	3.350
4.00	0.218	0.422	0.627	0.831	1.034	1.238	1.443	1.647	1.851	2.057	2.261	2.466	2.671	2.874	3.077	3.280
4.10	0.214	0.414	0.614	0.815	1.014	1.215	1.415	1.616	1.814	2.015	2.216	2.416	2.613	2.815	3.017	3.213
4.20	0.210	0.406	0.602	0.799	0.995	1.191	1.388	1.585	1.782	1.975	2.171	2.369	2.564	2.765	2.960	3.157
4.30	0.206	0.399	0.592	0.784	0.977	1.169	1.362	1.556	1.748	1.940	2.133	2.324	2.517	2.710	2.905	3.094
4.40	0.202	0.392	0.581	0.771	0.960	1.150	1.339	1.528	1.717	1.906	2.096	2.285	2.477	2.664	2.852	3.042
4.50	0.199	0.385	0.572	0.757	0.944	1.130	1.316	1.502	1.688	1.873	2.061	2.247	2.433	2.619	2.808	2.992
4.60	0.196	0.379	0.562	0.746	0.929	1.112	1.294	1.478	1.662	1.845	2.026	2.211	2.395	2.576	2.758	2.944
4.70	0.193	0.373	0.553	0.734	0.914	1.094	1.275	1.454	1.635	1.814	1.997	2.176	2.354	2.534	2.717	2.897
4.80	0.190	0.367	0.545	0.722	0.900	1.078	1.255	1.433	1.611	1.788	1.964	2.142	2.319	2.499	2.677	2.852
4.90	0.187	0.362	0.537	0.712	0.887	1.063	1.237	1.413	1.588	1.762	1.937	2.113	2.285	2.460	2.638	2.815
5.00	0.184	0.357	0.529	0.702	0.874	1.047	1.219	1.391	1.565	1.736	1.910	2.080	2.257	2.427	2.601	2.772
5.10	0.182	0.352	0.522	0.693	0.863	1.032	1.203	1.374	1.543	1.715	1.883	2.053	2.225	2.395	2.564	2.737
5.20	0.180	0.348	0.515	0.684	0.851	1.019	1.187	1.355	1.523	1.691	1.858	2.026	2.193	2.364	2.528	2.697
5.30	0.177	0.343	0.509	0.675	0.840	1.006	1.172	1.339	1.504	1.670	1.836	2.000	2.167	2.334	2.499	2.664
5.40	0.175	0.339	0.502	0.666	0.830	0.994	1.157	1.321	1.484	1.650	1.811	1.975	2.142	2.304	2.466	2.632
5.50	0.173	0.335	0.496	0.658	0.820	0.982	1.144	1.305	1.468	1.628	1.791	1.954	2.113	2.276	2.438	2.601
5.60	0.171	0.331	0.491	0.651	0.810	0.970	1.131	1.290	1.451	1.611	1.770	1.930	2.088	2.247	2.411	2.570
5.70	0.169	0.327	0.485	0.643	0.801	0.960	1.118	1.276	1.433	1.592	1.750	1.910	2.065	2.225	2.385	2.540
5.80	0.167	0.324	0.480	0.636	0.793	0.949	1.106	1.261	1.419	1.574	1.731	1.886	2.042	2.198	2.354	2.511
5.90	0.165	0.320	0.475	0.630	0.784	0.939	1.093	1.248	1.402	1.558	1.712	1.867	2.023	2.176	2.329	2.488
6.00	0.164	0.317	0.470	0.623	0.776	0.929	1.083	1.236	1.388	1.541	1.693	1.848	2.000	2.154	2.309	2.460
6.50	0.156	0.302	0.448	0.594	0.740	0.886	1.031	1.177	1.324	1.470	1.616	1.762	1.906	2.053	2.198	2.344
7.00	0.150	0.289	0.429	0.569	0.709	0.849	0.989	1.130	1.269	1.409	1.549	1.688	1.830	1.968	2.109	2.247
7.50	0.144	0.279	0.414	0.549	0.684	0.818	0.953	1.088	1.223	1.357	1.492	1.628	1.762	1.896	2.030	2.167
8.00	0.139	0.270	0.400	0.531	0.661	0.791	0.922	1.052	1.182	1.313	1.443	1.574	1.704	1.836	1.964	2.096
8.50	0.135	0.262	0.388	0.515	0.642	0.768	0.895	1.022	1.149	1.275	1.400	1.528	1.655	1.782	1.906	2.034
9.00	0.132	0.255	0.378	0.501	0.624	0.748	0.871	0.994	1.118	1.241	1.364	1.488	1.611	1.734	1.858	1.979
9.50	0.129	0.249	0.369	0.489	0.610	0.730	0.850	0.970	1.090	1.211	1.330	1.451	1.572	1.691	1.811	1.933
10.00	0.126	0.243	0.361	0.478	0.596	0.713	0.831	0.949	1.067	1.183	1.302	1.419	1.536	1.655	1.773	1.890
10.50	0.123	0.238	0.354	0.469	0.584	0.699	0.815	0.930	1.045	1.160	1.275	1.390	1.507	1.621	1.736	1.851
11.00	0.121	0.234	0.347	0.460	0.573	0.686	0.799	0.912	1.026	1.139	1.251	1.365	1.478	1.590	1.704	1.817
11.50	0.119	0.230	0.341	0.452	0.563	0.674	0.785	0.897	1.008	1.119	1.230	1.342	1.452	1.563	1.675	1.785
12.00	0.117	0.226	0.336	0.445	0.554	0.664	0.773	0.882	0.992	1.101	1.211	1.319	1.430	1.538	1.647	1.756
12.50	0.115	0.223	0.331	0.438	0.546	0.654	0.762	0.869	0.977	1.085	1.192	1.300	1.408	1.515	1.623	1.731

Curve: Moderately Inverse

Curve#:	1	2	3	4	5	6	7	8	9	10	11	12	13	14	15	16		
× P/U								Time to trip (seconds)										
13.00	0.114	0.220	0.326	0.432	0.539	0.645	0.751	0.857	0.963	1.070	1.176	1.282	1.388	1.494	1.602	1.707		
13.50	0.112	0.217	0.322	0.427	0.532	0.637	0.742	0.846	0.951	1.056	1.161	1.266	1.370	1.476	1.581	1.686		
14.00	0.111	0.214	0.318	0.422	0.525	0.629	0.733	0.836	0.939	1.043	1.147	1.250	1.353	1.458	1.560	1.665		
14.50	0.109	0.212	0.314	0.417	0.519	0.622	0.724	0.826	0.929	1.031	1.134	1.236	1.339	1.441	1.543	1.645		
15.00	0.108	0.210	0.311	0.412	0.514	0.615	0.716	0.818	0.919	1.021	1.121	1.223	1.324	1.426	1.528	1.628		
15.50	0.107	0.208	0.308	0.408	0.508	0.609	0.709	0.810	0.909	1.010	1.110	1.211	1.311	1.411	1.511	1.611		
16.00	0.106	0.206	0.305	0.404	0.504	0.603	0.702	0.802	0.901	1.000	1.100	1.199	1.299	1.399	1.498	1.597		
16.50	0.105	0.204	0.302	0.401	0.499	0.598	0.696	0.794	0.893	0.991	1.090	1.189	1.287	1.386	1.484	1.583		
17.00	0.104	0.202	0.300	0.397	0.495	0.593	0.690	0.788	0.886	0.983	1.080	1.178	1.276	1.374	1.472	1.569		
17.50	0.104	0.200	0.297	0.394	0.491	0.588	0.685	0.781	0.879	0.975	1.072	1.169	1.266	1.362	1.460	1.556		
18.00	0.103	0.199	0.295	0.391	0.487	0.583	0.679	0.776	0.872	0.967	1.064	1.160	1.257	1.352	1.449	1.545		
18.50	0.102	0.197	0.293	0.388	0.484	0.579	0.675	0.770	0.865	0.961	1.056	1.152	1.247	1.342	1.437	1.534		
19.00	0.101	0.196	0.291	0.386	0.480	0.575	0.670	0.765	0.859	0.954	1.049	1.144	1.238	1.334	1.428	1.523		
19.50	0.101	0.195	0.289	0.383	0.477	0.571	0.666	0.760	0.854	0.948	1.042	1.137	1.230	1.324	1.419	1.513		
20.00	0.100	0.194	0.287	0.381	0.474	0.568	0.661	0.755	0.849	0.942	1.035	1.130	1.223	1.316	1.409	1.502		

www.ElectricalPartManuals.com

CURVE INFORMATION AND TABLES



Curve: Moderately Inverse

Curve#:	17	18	19	20	21	22	23	24	25	26	27	28	29	30	31	32
× P/U																
	Time to trip (seconds)															
1.03	33.098	34.133	36.408	39.009	40.454	42.010	43.690	45.510	47.489	49.648	52.012	54.613	54.613	57.487	60.681	60.681
1.10	25.401	26.640	28.006	29.520	31.207	33.098	34.133	35.234	37.664	39.009	40.454	42.010	43.690	45.510	45.510	47.489
1.20	19.504	20.608	21.417	22.755	23.745	24.824	26.006	27.306	28.743	29.520	30.340	32.125	33.098	34.133	35.234	36.408
1.30	15.604	16.549	17.617	18.513	19.504	20.227	21.417	22.291	23.239	23.745	24.824	26.006	26.640	28.006	28.743	29.520
1.40	13.320	14.003	14.760	15.604	16.302	17.066	17.906	18.832	19.504	20.227	21.005	21.845	22.755	23.239	24.272	24.824
1.50	11.620	12.272	13.003	13.653	14.372	14.962	15.604	16.302	17.066	17.617	18.204	19.162	19.859	20.227	21.005	21.845
1.60	10.304	10.923	11.497	12.136	12.701	13.320	13.826	14.563	15.170	15.604	16.302	16.804	17.617	18.204	18.832	19.162
1.70	9.256	9.840	10.402	10.923	11.497	12.003	12.555	13.003	13.653	14.185	14.760	15.170	15.830	16.302	16.804	17.337
1.80	8.467	8.953	9.498	9.930	10.402	10.923	11.497	12.003	12.412	13.003	13.485	14.003	14.372	14.962	15.384	15.830
1.90	7.802	8.275	8.738	9.179	9.666	10.113	10.604	11.033	11.497	11.872	12.412	12.850	13.320	13.826	14.185	14.760
2.00	7.282	7.692	8.091	8.533	8.953	9.416	9.840	10.208	10.708	11.033	11.497	12.003	12.412	12.850	13.160	13.653
2.10	6.784	7.186	7.585	7.973	8.402	8.808	9.179	9.581	10.021	10.402	10.814	11.145	11.620	12.003	12.412	12.701
2.20	6.387	6.784	7.139	7.533	7.915	8.275	8.669	9.027	9.416	9.752	10.113	10.502	10.923	11.260	11.620	12.003
2.30	6.068	6.387	6.742	7.093	7.481	7.802	8.151	8.533	8.880	9.256	9.581	9.930	10.304	10.708	11.033	11.378
2.40	5.749	6.102	6.425	6.742	7.093	7.430	7.746	8.091	8.467	8.808	9.102	9.416	9.752	10.113	10.502	10.814
2.50	5.489	5.810	6.136	6.463	6.784	7.093	7.430	7.746	8.031	8.402	8.669	9.027	9.335	9.666	10.021	10.304
2.60	5.251	5.544	5.872	6.171	6.463	6.784	7.093	7.380	7.692	8.031	8.338	8.600	8.953	9.256	9.581	9.840
2.70	5.033	5.328	5.630	5.904	6.206	6.501	6.784	7.093	7.380	7.692	7.973	8.275	8.600	8.880	9.179	9.498
2.80	4.833	5.128	5.407	5.689	5.969	6.277	6.540	6.827	7.093	7.380	7.692	7.973	8.275	8.533	8.808	9.102
2.90	4.668	4.942	5.226	5.489	5.779	6.035	6.314	6.580	6.869	7.139	7.430	7.692	7.973	8.212	8.533	8.808
3.00	4.513	4.770	5.033	5.302	5.573	5.841	6.102	6.350	6.620	6.913	7.139	7.430	7.692	7.973	8.212	8.467
3.10	4.369	4.628	4.876	5.128	5.407	5.659	5.904	6.171	6.425	6.660	6.913	7.186	7.430	7.692	7.973	8.212
3.20	4.234	4.495	4.728	4.987	5.226	5.489	5.719	5.969	6.241	6.463	6.742	6.957	7.233	7.481	7.692	7.973
3.30	4.122	4.352	4.609	4.833	5.080	5.328	5.573	5.810	6.035	6.277	6.540	6.784	7.002	7.233	7.481	7.746
3.40	4.001	4.250	4.476	4.708	4.942	5.177	5.407	5.659	5.872	6.136	6.350	6.580	6.827	7.047	7.282	7.533
3.50	3.901	4.137	4.369	4.589	4.812	5.057	5.277	5.516	5.719	5.969	6.206	6.425	6.660	6.869	7.093	7.331
3.60	3.806	4.030	4.250	4.476	4.708	4.920	5.152	5.381	5.601	5.810	6.035	6.277	6.501	6.701	6.913	7.139
3.70	3.715	3.943	4.153	4.369	4.589	4.812	5.033	5.251	5.461	5.689	5.904	6.102	6.350	6.540	6.784	7.002
3.80	3.641	3.846	4.060	4.267	4.495	4.708	4.920	5.128	5.328	5.544	5.779	5.969	6.206	6.387	6.620	6.827
3.90	3.558	3.766	3.972	4.185	4.387	4.609	4.812	5.010	5.226	5.434	5.630	5.841	6.068	6.277	6.463	6.701
4.00	3.490	3.690	3.887	4.091	4.300	4.513	4.708	4.920	5.128	5.328	5.516	5.719	5.936	6.136	6.350	6.540
4.10	3.413	3.617	3.819	4.016	4.217	4.422	4.609	4.812	5.010	5.226	5.407	5.630	5.810	6.001	6.206	6.425
4.20	3.350	3.546	3.741	3.943	4.137	4.334	4.532	4.728	4.920	5.128	5.302	5.516	5.719	5.904	6.102	6.314
4.30	3.290	3.479	3.678	3.873	4.060	4.250	4.440	4.648	4.833	5.033	5.226	5.407	5.601	5.810	6.001	6.171
4.40	3.232	3.424	3.617	3.806	3.986	4.185	4.369	4.551	4.749	4.942	5.128	5.328	5.516	5.689	5.872	6.068
4.50	3.175	3.361	3.546	3.741	3.929	4.106	4.300	4.476	4.668	4.854	5.033	5.226	5.407	5.601	5.779	5.969
4.60	3.130	3.310	3.490	3.678	3.860	4.045	4.234	4.404	4.589	4.770	4.965	5.152	5.328	5.516	5.689	5.872
4.70	3.077	3.260	3.435	3.617	3.793	3.986	4.153	4.334	4.513	4.708	4.876	5.057	5.251	5.434	5.601	5.779
4.80	3.034	3.213	3.382	3.569	3.741	3.915	4.091	4.267	4.458	4.628	4.812	4.987	5.152	5.328	5.516	5.689
4.90	2.984	3.166	3.340	3.512	3.690	3.860	4.030	4.217	4.387	4.570	4.728	4.920	5.080	5.251	5.434	5.601
5.00	2.944	3.121	3.290	3.467	3.641	3.806	3.986	4.153	4.317	4.495	4.668	4.833	5.010	5.177	5.354	5.544
5.10	2.905	3.077	3.241	3.413	3.581	3.753	3.929	4.091	4.267	4.440	4.609	4.770	4.942	5.128	5.277	5.461
5.20	2.867	3.034	3.203	3.371	3.535	3.703	3.873	4.045	4.217	4.387	4.551	4.708	4.876	5.057	5.226	5.381
5.30	2.830	2.992	3.166	3.330	3.490	3.653	3.819	3.986	4.153	4.317	4.495	4.648	4.812	4.987	5.152	5.328
5.40	2.793	2.960	3.121	3.290	3.446	3.617	3.779	3.943	4.106	4.267	4.440	4.589	4.770	4.920	5.080	5.251
5.50	2.758	2.920	3.085	3.251	3.413	3.569	3.728	3.887	4.060	4.217	4.387	4.532	4.708	4.854	5.033	5.177
5.60	2.731	2.890	3.051	3.213	3.371	3.523	3.690	3.846	4.016	4.169	4.334	4.495	4.648	4.812	4.965	5.128
5.70	2.697	2.859	3.017	3.175	3.330	3.490	3.653	3.806	3.957	4.122	4.283	4.440	4.589	4.749	4.920	5.080
5.80	2.671	2.822	2.984	3.139	3.290	3.446	3.605	3.766	3.915	4.076	4.234	4.387	4.551	4.708	4.854	5.010
5.90	2.638	2.793	2.952	3.103	3.260	3.413	3.569	3.728	3.873	4.030	4.185	4.334	4.495	4.648	4.812	4.965
6.00	2.613	2.765	2.920	3.068	3.222	3.382	3.535	3.690	3.832	3.986	4.137	4.300	4.458	4.609	4.749	4.920
6.50	2.494	2.638	2.779	2.928	3.077	3.222	3.371	3.512	3.653	3.806	3.943	4.091	4.250	4.387	4.532	4.688
7.00	2.390	2.528	2.671	2.808	2.944	3.085	3.232	3.371	3.512	3.653	3.793	3.929	4.060	4.201	4.352	4.495
7.50	2.299	2.438	2.570	2.704	2.837	2.976	3.112	3.241	3.382	3.512	3.653	3.779	3.915	4.060	4.185	4.317
8.00	2.225	2.354	2.488	2.619	2.744	2.874	3.009	3.139	3.270	3.403	3.535	3.665	3.793	3.915	4.045	4.185
8.50	2.159	2.285	2.411	2.540	2.664	2.793	2.920	3.042	3.175	3.300	3.424	3.558	3.678	3.806	3.929	4.060
9.00	2.105	2.225	2.349	2.471	2.594	2.717	2.844	2.968	3.085	3.213	3.340	3.456	3.581	3.703	3.832	3.957
9.50	2.053	2.171	2.295	2.411	2.534	2.651	2.772	2.897	3.017	3.139	3.251	3.371	3.501	3.617	3.741	3.860
10.00	2.008	2.125	2.243	2.359	2.477	2.594	2.710	2.830	2.944	3.068	3.184	3.300	3.413	3.535	3.653	3.766
10.50	1.968	2.080	2.198	2.314	2.427	2.540	2.658	2.772	2.890	3.001	3.121	3.232	3.350	3.467	3.581	3.690
11.00	1.930	2.042	2.154	2.271	2.380	2.494	2.607	2.724	2.837	2.944	3.060	3.175	3.290	3.403	3.512	3.629
11.50	1.896	2.008	2.121	2.229	2.339	2.454	2.564	2.677	2.786	2.897	3.009	3.121	3.232	3.340	3.456	3.558
12.00	1.867	1.975	2.084	2.193	2.304	2.411	2.523	2.632	2.744	2.852	2.960	3.068	3.175	3.290	3.392	3.512
12.50	1.839	1.947	2.053	2.163	2.271	2.380	2.482	2.594	2.704	2.808	2.913	3.026	3.130	3.241	3.350	3.456

Curve: Moderately Inverse

Curve#:	17	18	19	20	21	22	23	24	25	26	27	28	29	30	31	32		
× P/U								Time to trip (seconds)										
13.00	1.814	1.920	2.026	2.133	2.238	2.344	2.449	2.558	2.664	2.772	2.874	2.984	3.085	3.194	3.300	3.403		
13.50	1.791	1.896	2.000	2.105	2.211	2.314	2.422	2.523	2.632	2.731	2.837	2.944	3.051	3.157	3.260	3.361		
14.00	1.767	1.873	1.975	2.080	2.185	2.285	2.390	2.494	2.594	2.704	2.808	2.905	3.009	3.112	3.222	3.320		
14.50	1.748	1.851	1.954	2.057	2.159	2.261	2.364	2.466	2.570	2.671	2.772	2.874	2.976	3.077	3.184	3.280		
15.00	1.731	1.830	1.933	2.034	2.133	2.238	2.339	2.438	2.540	2.645	2.744	2.844	2.944	3.051	3.148	3.251		
15.50	1.712	1.811	1.913	2.012	2.113	2.216	2.314	2.416	2.517	2.613	2.717	2.815	2.913	3.017	3.121	3.213		
16.00	1.696	1.796	1.896	1.993	2.092	2.193	2.295	2.390	2.494	2.588	2.690	2.786	2.890	2.984	3.085	3.184		
16.50	1.680	1.779	1.877	1.975	2.077	2.171	2.271	2.369	2.471	2.570	2.664	2.765	2.859	2.960	3.060	3.157		
17.00	1.668	1.765	1.861	1.961	2.057	2.154	2.252	2.349	2.449	2.546	2.645	2.737	2.837	2.936	3.034	3.130		
17.50	1.652	1.750	1.848	1.944	2.042	2.137	2.234	2.329	2.427	2.523	2.619	2.717	2.815	2.913	3.009	3.103		
18.00	1.640	1.736	1.833	1.930	2.026	2.121	2.216	2.314	2.411	2.505	2.601	2.697	2.793	2.890	2.984	3.085		
18.50	1.628	1.726	1.820	1.916	2.012	2.105	2.202	2.295	2.390	2.488	2.582	2.677	2.772	2.867	2.968	3.060		
19.00	1.618	1.712	1.808	1.903	1.997	2.092	2.185	2.280	2.374	2.471	2.564	2.658	2.751	2.852	2.944	3.042		
19.50	1.606	1.701	1.796	1.890	1.982	2.077	2.171	2.266	2.359	2.454	2.546	2.645	2.737	2.830	2.928	3.017		
20.00	1.597	1.691	1.785	1.877	1.972	2.065	2.159	2.252	2.344	2.438	2.534	2.626	2.717	2.815	2.905	3.001		

www.ElectricalPartManagers.com

CURVE INFORMATION AND TABLES



Curve: Very Inverse

Curve#:	1	2	3	4	5	6	7	8	9	10	11	12	13	14	15	16
× P/U	Time to trip (seconds)															
1.03	4.422	11.497	18.513	25.401	33.098	40.454	47.489	54.613	60.681	68.266	72.817	84.019	91.021	99.295	99.295	109.225
1.10	1.340	3.490	5.630	7.802	9.930	12.136	14.185	16.302	18.513	20.608	22.755	24.824	27.306	29.520	31.207	33.098
1.20	0.680	1.770	2.859	3.943	5.033	6.136	7.233	8.338	9.416	10.502	11.620	12.701	13.826	14.760	15.830	17.066
1.30	0.460	1.198	1.933	2.671	3.413	4.153	4.876	5.630	6.350	7.093	7.858	8.600	9.335	10.021	10.814	11.497
1.40	0.350	0.911	1.472	2.034	2.594	3.157	3.715	4.283	4.833	5.407	5.969	6.540	7.093	7.638	8.212	8.738
1.50	0.284	0.740	1.195	1.650	2.105	2.558	3.017	3.467	3.929	4.387	4.833	5.302	5.749	6.206	6.660	7.093
1.60	0.240	0.625	1.009	1.395	1.779	2.163	2.546	2.936	3.320	3.703	4.091	4.476	4.854	5.251	5.630	6.001
1.70	0.209	0.543	0.877	1.212	1.547	1.880	2.216	2.552	2.882	3.222	3.558	3.887	4.217	4.551	4.898	5.226
1.80	0.185	0.482	0.778	1.075	1.372	1.668	1.964	2.261	2.558	2.852	3.148	3.446	3.741	4.045	4.334	4.628
1.90	0.167	0.434	0.701	0.968	1.236	1.502	1.770	2.038	2.304	2.570	2.837	3.103	3.371	3.641	3.901	4.169
2.00	0.152	0.396	0.639	0.883	1.127	1.370	1.613	1.858	2.100	2.344	2.588	2.830	3.077	3.320	3.558	3.806
2.10	0.140	0.365	0.589	0.813	1.038	1.263	1.486	1.712	1.937	2.159	2.385	2.607	2.837	3.060	3.280	3.512
2.20	0.130	0.338	0.547	0.755	0.964	1.172	1.381	1.590	1.796	2.004	2.216	2.422	2.632	2.837	3.051	3.260
2.30	0.122	0.317	0.511	0.706	0.901	1.096	1.291	1.486	1.680	1.877	2.069	2.266	2.460	2.658	2.852	3.042
2.40	0.114	0.298	0.481	0.664	0.847	1.030	1.214	1.397	1.581	1.765	1.947	2.129	2.314	2.494	2.677	2.859
2.50	0.108	0.281	0.454	0.628	0.801	0.973	1.147	1.321	1.494	1.668	1.839	2.012	2.185	2.359	2.534	2.704
2.60	0.103	0.267	0.431	0.596	0.760	0.924	1.089	1.253	1.417	1.581	1.745	1.910	2.077	2.238	2.406	2.570
2.70	0.098	0.254	0.411	0.567	0.724	0.881	1.037	1.194	1.350	1.507	1.662	1.820	1.975	2.133	2.290	2.444
2.80	0.093	0.243	0.393	0.542	0.692	0.841	0.991	1.141	1.291	1.441	1.590	1.739	1.890	2.038	2.189	2.339
2.90	0.090	0.233	0.377	0.520	0.664	0.807	0.951	1.093	1.237	1.381	1.523	1.668	1.811	1.954	2.096	2.243
3.00	0.086	0.224	0.362	0.500	0.638	0.776	0.913	1.051	1.190	1.327	1.464	1.604	1.742	1.880	2.015	2.154
3.10	0.083	0.216	0.349	0.482	0.614	0.747	0.880	1.013	1.146	1.279	1.411	1.545	1.678	1.811	1.944	2.077
3.20	0.080	0.208	0.337	0.465	0.593	0.721	0.850	0.978	1.107	1.234	1.364	1.492	1.621	1.748	1.877	2.004
3.30	0.077	0.202	0.326	0.450	0.574	0.698	0.822	0.946	1.070	1.195	1.319	1.443	1.567	1.691	1.814	1.940
3.40	0.075	0.195	0.316	0.436	0.556	0.676	0.797	0.917	1.037	1.157	1.277	1.399	1.519	1.638	1.759	1.880
3.50	0.073	0.190	0.306	0.423	0.540	0.656	0.774	0.890	1.007	1.124	1.240	1.357	1.474	1.590	1.707	1.823
3.60	0.071	0.184	0.298	0.411	0.525	0.638	0.752	0.865	0.979	1.092	1.206	1.319	1.433	1.547	1.660	1.773
3.70	0.069	0.179	0.290	0.400	0.511	0.621	0.732	0.842	0.953	1.064	1.173	1.283	1.395	1.504	1.616	1.726
3.80	0.067	0.175	0.283	0.390	0.498	0.605	0.713	0.821	0.929	1.036	1.144	1.251	1.359	1.466	1.574	1.683
3.90	0.066	0.171	0.276	0.381	0.486	0.591	0.696	0.801	0.906	1.011	1.117	1.222	1.327	1.432	1.536	1.642
4.00	0.064	0.167	0.269	0.372	0.475	0.577	0.680	0.782	0.885	0.988	1.090	1.194	1.296	1.399	1.500	1.604
4.10	0.063	0.163	0.263	0.364	0.464	0.564	0.665	0.765	0.865	0.966	1.067	1.167	1.267	1.367	1.468	1.567
4.20	0.061	0.160	0.258	0.356	0.454	0.552	0.651	0.749	0.847	0.946	1.043	1.141	1.240	1.339	1.437	1.534
4.30	0.060	0.156	0.253	0.349	0.445	0.541	0.638	0.734	0.830	0.926	1.023	1.119	1.215	1.311	1.408	1.504
4.40	0.059	0.153	0.248	0.342	0.436	0.531	0.625	0.720	0.814	0.908	1.002	1.097	1.191	1.285	1.379	1.474
4.50	0.058	0.150	0.243	0.335	0.428	0.521	0.613	0.706	0.798	0.891	0.983	1.076	1.168	1.261	1.353	1.447
4.60	0.057	0.148	0.238	0.329	0.420	0.511	0.602	0.693	0.784	0.874	0.966	1.056	1.147	1.238	1.329	1.420
4.70	0.056	0.145	0.234	0.324	0.413	0.502	0.592	0.681	0.770	0.859	0.949	1.038	1.127	1.216	1.307	1.395
4.80	0.055	0.143	0.230	0.318	0.406	0.494	0.582	0.669	0.757	0.845	0.933	1.021	1.109	1.196	1.283	1.372
4.90	0.054	0.140	0.227	0.313	0.399	0.486	0.572	0.658	0.745	0.831	0.918	1.004	1.090	1.177	1.263	1.350
5.00	0.053	0.138	0.223	0.308	0.393	0.478	0.563	0.648	0.733	0.818	0.903	0.988	1.073	1.158	1.243	1.329
5.10	0.052	0.136	0.220	0.303	0.387	0.471	0.555	0.638	0.722	0.805	0.889	0.973	1.057	1.140	1.224	1.308
5.20	0.051	0.134	0.216	0.299	0.382	0.464	0.546	0.629	0.712	0.794	0.877	0.959	1.041	1.124	1.207	1.290
5.30	0.051	0.132	0.213	0.295	0.376	0.457	0.539	0.620	0.702	0.782	0.864	0.946	1.027	1.108	1.190	1.270
5.40	0.050	0.130	0.210	0.291	0.371	0.451	0.531	0.612	0.692	0.772	0.852	0.932	1.012	1.092	1.173	1.253
5.50	0.049	0.129	0.208	0.287	0.366	0.445	0.524	0.603	0.683	0.762	0.841	0.920	0.999	1.078	1.157	1.237
5.60	0.049	0.127	0.205	0.283	0.361	0.439	0.517	0.596	0.674	0.752	0.830	0.908	0.986	1.065	1.143	1.220
5.70	0.048	0.125	0.202	0.280	0.357	0.434	0.511	0.588	0.665	0.743	0.819	0.897	0.973	1.051	1.128	1.206
5.80	0.048	0.124	0.200	0.276	0.352	0.429	0.505	0.581	0.657	0.734	0.810	0.886	0.962	1.038	1.115	1.191
5.90	0.047	0.122	0.198	0.273	0.348	0.424	0.499	0.574	0.649	0.725	0.800	0.875	0.951	1.026	1.101	1.177
6.00	0.046	0.121	0.195	0.270	0.344	0.419	0.493	0.567	0.642	0.716	0.791	0.865	0.940	1.014	1.089	1.163
6.50	0.044	0.115	0.185	0.256	0.326	0.397	0.468	0.538	0.609	0.679	0.750	0.821	0.891	0.961	1.032	1.103
7.00	0.042	0.109	0.177	0.244	0.312	0.379	0.446	0.514	0.581	0.649	0.716	0.784	0.851	0.918	0.986	1.053
7.50	0.040	0.105	0.170	0.234	0.299	0.364	0.428	0.493	0.558	0.622	0.687	0.752	0.816	0.881	0.946	1.010
8.00	0.039	0.101	0.164	0.226	0.288	0.351	0.413	0.475	0.538	0.600	0.662	0.725	0.787	0.849	0.912	0.974
8.50	0.038	0.098	0.158	0.219	0.279	0.339	0.400	0.460	0.520	0.581	0.641	0.702	0.762	0.822	0.882	0.942
9.00	0.037	0.095	0.154	0.212	0.271	0.329	0.388	0.447	0.505	0.564	0.622	0.681	0.740	0.798	0.857	0.915
9.50	0.036	0.093	0.150	0.207	0.264	0.321	0.378	0.435	0.492	0.549	0.606	0.663	0.720	0.777	0.834	0.891
10.00	0.035	0.090	0.146	0.202	0.257	0.313	0.369	0.424	0.480	0.535	0.591	0.647	0.702	0.758	0.813	0.869
10.50	0.034	0.088	0.143	0.197	0.251	0.306	0.360	0.415	0.469	0.523	0.578	0.632	0.687	0.741	0.796	0.850
11.00	0.033	0.087	0.140	0.193	0.246	0.300	0.353	0.406	0.460	0.513	0.566	0.619	0.673	0.726	0.779	0.833
11.50	0.033	0.085	0.137	0.189	0.242	0.294	0.346	0.398	0.451	0.503	0.555	0.607	0.660	0.712	0.764	0.817
12.00	0.032	0.083	0.135	0.186	0.237	0.289	0.340	0.391	0.443	0.494	0.546	0.597	0.648	0.700	0.751	0.803
12.50	0.032	0.082	0.133	0.183	0.234	0.284	0.335	0.385	0.436	0.486	0.537	0.587	0.638	0.688	0.739	0.789

Curve: Very Inverse

Curve#:	1	2	3	4	5	6	7	8	9	10	11	12	13	14	15	16		
× P/U																		
								Time to trip (seconds)										
13.00	0.031	0.081	0.131	0.180	0.230	0.280	0.330	0.379	0.429	0.479	0.529	0.578	0.628	0.678	0.728	0.777		
13.50	0.031	0.080	0.129	0.178	0.227	0.276	0.325	0.374	0.423	0.472	0.521	0.570	0.619	0.668	0.717	0.766		
14.00	0.030	0.079	0.127	0.175	0.224	0.272	0.321	0.369	0.417	0.466	0.514	0.562	0.611	0.659	0.708	0.756		
14.50	0.030	0.078	0.125	0.173	0.221	0.269	0.317	0.364	0.412	0.460	0.508	0.556	0.603	0.651	0.699	0.747		
15.00	0.029	0.077	0.124	0.171	0.218	0.266	0.313	0.360	0.407	0.455	0.502	0.549	0.596	0.644	0.691	0.738		
15.50	0.029	0.076	0.123	0.169	0.216	0.263	0.309	0.356	0.403	0.450	0.496	0.543	0.590	0.637	0.683	0.730		
16.00	0.029	0.075	0.121	0.168	0.214	0.260	0.306	0.352	0.399	0.445	0.491	0.537	0.583	0.630	0.676	0.722		
16.50	0.029	0.074	0.120	0.166	0.212	0.257	0.303	0.349	0.395	0.441	0.486	0.532	0.578	0.624	0.669	0.715		
17.00	0.028	0.074	0.119	0.164	0.210	0.255	0.300	0.346	0.391	0.436	0.482	0.527	0.572	0.618	0.663	0.708		
17.50	0.028	0.073	0.118	0.163	0.208	0.253	0.298	0.343	0.388	0.433	0.478	0.522	0.567	0.612	0.657	0.702		
18.00	0.028	0.072	0.117	0.162	0.206	0.251	0.295	0.340	0.384	0.429	0.473	0.518	0.563	0.607	0.652	0.696		
18.50	0.028	0.072	0.116	0.160	0.204	0.249	0.293	0.337	0.381	0.425	0.470	0.514	0.558	0.602	0.647	0.691		
19.00	0.027	0.071	0.115	0.159	0.203	0.247	0.291	0.335	0.378	0.422	0.466	0.510	0.554	0.598	0.642	0.686		
19.50	0.027	0.071	0.114	0.158	0.201	0.245	0.289	0.332	0.376	0.419	0.463	0.506	0.550	0.594	0.637	0.681		
20.00	0.027	0.070	0.114	0.157	0.200	0.243	0.287	0.330	0.373	0.416	0.460	0.503	0.546	0.589	0.632	0.676		

www.ElectricalPartMan.com

CURVE INFORMATION AND TABLES



Curve: Very Inverse

Curve#:	17	18	19	20	21	22	23	24	25	26	27	28	29	30	31	32
× P/U	Time to trip (seconds)															
1.03	121.361	121.361	136.531	136.531	156.036	156.036	156.036	156.036	182.042	182.042	182.042	182.042	218.450	218.450	218.450	218.450
1.10	35.234	37.664	40.454	42.010	43.690	45.510	49.648	49.648	52.012	54.613	57.487	60.681	60.681	64.250	64.250	68.266
1.20	18.204	19.162	20.227	21.417	22.291	23.745	24.824	26.006	26.640	28.006	28.743	30.340	31.207	32.125	33.098	34.133
1.30	12.272	13.003	13.653	14.563	15.170	15.830	16.804	17.337	18.204	18.832	19.504	20.227	21.005	21.845	22.755	23.239
1.40	9.335	9.930	10.402	11.033	11.620	12.136	12.701	13.320	13.826	14.372	14.962	15.604	16.063	16.549	17.066	17.617
1.50	7.585	8.031	8.467	8.953	9.416	9.840	10.304	10.708	11.260	11.620	12.136	12.555	13.003	13.485	14.003	14.372
1.60	6.387	6.784	7.186	7.533	7.915	8.338	8.738	9.102	9.498	9.840	10.208	10.604	11.033	11.378	11.745	12.136
1.70	5.544	5.904	6.241	6.580	6.913	7.233	7.585	7.915	8.212	8.600	8.880	9.256	9.581	9.930	10.208	10.604
1.80	4.920	5.226	5.516	5.810	6.102	6.425	6.701	7.002	7.282	7.585	7.915	8.212	8.467	8.808	9.102	9.416
1.90	4.440	4.708	4.965	5.251	5.516	5.779	6.035	6.314	6.580	6.827	7.093	7.380	7.638	7.915	8.212	8.467
2.00	4.045	4.300	4.532	4.791	5.033	5.277	5.516	5.749	6.001	6.241	6.501	6.742	6.957	7.233	7.481	7.692
2.10	3.728	3.957	4.185	4.404	4.628	4.854	5.080	5.302	5.516	5.749	5.969	6.206	6.425	6.660	6.869	7.093
2.20	3.467	3.678	3.887	4.091	4.300	4.513	4.708	4.920	5.128	5.328	5.544	5.749	5.969	6.171	6.387	6.580
2.30	3.241	3.435	3.629	3.819	4.016	4.217	4.404	4.609	4.791	4.987	5.177	5.381	5.573	5.779	5.969	6.171
2.40	3.042	3.232	3.413	3.593	3.779	3.957	4.153	4.334	4.513	4.688	4.876	5.057	5.251	5.434	5.601	5.810
2.50	2.882	3.051	3.222	3.403	3.569	3.741	3.915	4.091	4.267	4.440	4.609	4.791	4.965	5.128	5.302	5.489
2.60	2.731	2.897	3.060	3.222	3.392	3.558	3.715	3.887	4.045	4.217	4.369	4.532	4.708	4.876	5.033	5.201
2.70	2.601	2.758	2.913	3.077	3.232	3.382	3.546	3.703	3.860	4.016	4.169	4.317	4.476	4.648	4.791	4.942
2.80	2.488	2.638	2.786	2.936	3.085	3.232	3.382	3.535	3.690	3.832	3.986	4.137	4.283	4.440	4.589	4.728
2.90	2.385	2.528	2.671	2.815	2.960	3.103	3.241	3.392	3.535	3.678	3.819	3.957	4.106	4.250	4.387	4.532
3.00	2.295	2.433	2.570	2.704	2.844	2.984	3.121	3.260	3.392	3.535	3.678	3.806	3.943	4.091	4.217	4.369
3.10	2.207	2.344	2.477	2.607	2.737	2.874	3.009	3.139	3.270	3.403	3.535	3.665	3.806	3.929	4.076	4.201
3.20	2.133	2.261	2.390	2.517	2.645	2.772	2.905	3.034	3.157	3.290	3.413	3.546	3.678	3.806	3.929	4.060
3.30	2.065	2.189	2.309	2.438	2.558	2.684	2.808	2.928	3.060	3.184	3.300	3.424	3.558	3.678	3.806	3.929
3.40	2.000	2.121	2.238	2.359	2.482	2.601	2.724	2.844	2.960	3.085	3.203	3.320	3.446	3.558	3.678	3.806
3.50	1.940	2.057	2.176	2.290	2.406	2.523	2.638	2.758	2.874	2.992	3.112	3.222	3.340	3.456	3.569	3.690
3.60	1.886	2.000	2.113	2.229	2.339	2.454	2.570	2.684	2.793	2.905	3.026	3.139	3.251	3.361	3.479	3.593
3.70	1.836	1.947	2.057	2.167	2.280	2.390	2.499	2.607	2.717	2.830	2.944	3.051	3.166	3.270	3.382	3.490
3.80	1.791	1.896	2.004	2.113	2.220	2.329	2.438	2.546	2.651	2.758	2.867	2.976	3.085	3.194	3.300	3.403
3.90	1.748	1.851	1.957	2.061	2.167	2.271	2.380	2.482	2.588	2.690	2.801	2.905	3.009	3.112	3.222	3.320
4.00	1.707	1.808	1.913	2.015	2.117	2.220	2.324	2.427	2.528	2.632	2.731	2.837	2.936	3.042	3.148	3.251
4.10	1.668	1.770	1.870	1.968	2.069	2.171	2.271	2.369	2.471	2.570	2.671	2.772	2.874	2.976	3.077	3.175
4.20	1.633	1.731	1.830	1.926	2.026	2.125	2.225	2.319	2.416	2.517	2.613	2.710	2.815	2.913	3.009	3.103
4.30	1.599	1.696	1.794	1.890	1.986	2.080	2.176	2.276	2.369	2.466	2.564	2.658	2.751	2.852	2.944	3.042
4.40	1.569	1.662	1.756	1.851	1.947	2.042	2.133	2.229	2.324	2.416	2.511	2.607	2.704	2.793	2.890	2.984
4.50	1.538	1.630	1.723	1.817	1.910	2.000	2.092	2.189	2.280	2.374	2.466	2.558	2.651	2.744	2.837	2.928
4.60	1.511	1.602	1.693	1.785	1.873	1.964	2.057	2.146	2.238	2.329	2.422	2.511	2.601	2.690	2.786	2.874
4.70	1.484	1.574	1.662	1.753	1.842	1.930	2.019	2.109	2.198	2.290	2.380	2.466	2.558	2.645	2.737	2.822
4.80	1.460	1.547	1.635	1.723	1.811	1.900	1.986	2.073	2.163	2.247	2.339	2.427	2.511	2.601	2.690	2.779
4.90	1.435	1.521	1.609	1.696	1.782	1.867	1.954	2.042	2.125	2.211	2.299	2.385	2.471	2.558	2.645	2.731
5.00	1.413	1.498	1.583	1.668	1.753	1.839	1.923	2.008	2.092	2.180	2.261	2.349	2.433	2.517	2.601	2.690
5.10	1.391	1.476	1.560	1.642	1.726	1.811	1.893	1.979	2.061	2.146	2.229	2.314	2.395	2.482	2.564	2.645
5.20	1.372	1.454	1.536	1.618	1.701	1.785	1.867	1.950	2.030	2.113	2.198	2.280	2.359	2.444	2.528	2.607
5.30	1.352	1.433	1.515	1.597	1.678	1.759	1.839	1.920	2.004	2.084	2.167	2.247	2.329	2.411	2.488	2.570
5.40	1.334	1.413	1.494	1.574	1.655	1.734	1.814	1.896	1.975	2.057	2.133	2.216	2.295	2.374	2.454	2.534
5.50	1.316	1.395	1.474	1.554	1.633	1.712	1.791	1.870	1.947	2.026	2.109	2.185	2.266	2.344	2.422	2.505
5.60	1.299	1.377	1.454	1.532	1.611	1.688	1.767	1.845	1.923	2.000	2.080	2.159	2.234	2.314	2.390	2.471
5.70	1.282	1.360	1.437	1.513	1.590	1.668	1.745	1.823	1.900	1.975	2.053	2.129	2.207	2.285	2.364	2.438
5.80	1.267	1.343	1.419	1.496	1.572	1.647	1.723	1.799	1.877	1.954	2.030	2.105	2.180	2.257	2.334	2.411
5.90	1.251	1.327	1.402	1.478	1.554	1.628	1.704	1.779	1.854	1.930	2.004	2.080	2.154	2.229	2.304	2.380
6.00	1.237	1.311	1.386	1.460	1.536	1.609	1.683	1.759	1.833	1.906	1.982	2.057	2.129	2.207	2.280	2.354
6.50	1.173	1.244	1.314	1.384	1.456	1.525	1.597	1.668	1.739	1.808	1.880	1.950	2.019	2.092	2.163	2.234
7.00	1.120	1.187	1.255	1.322	1.390	1.456	1.525	1.592	1.660	1.726	1.794	1.861	1.930	1.997	2.065	2.129
7.50	1.075	1.140	1.204	1.269	1.334	1.399	1.462	1.528	1.592	1.657	1.723	1.788	1.851	1.916	1.979	2.045
8.00	1.036	1.099	1.161	1.223	1.287	1.348	1.411	1.472	1.536	1.597	1.660	1.723	1.785	1.848	1.910	1.972
8.50	1.003	1.064	1.124	1.183	1.244	1.305	1.365	1.426	1.486	1.545	1.606	1.668	1.728	1.788	1.848	1.910
9.00	0.973	1.032	1.091	1.150	1.208	1.267	1.326	1.384	1.443	1.500	1.560	1.618	1.675	1.734	1.794	1.851
9.50	0.948	1.005	1.061	1.119	1.176	1.233	1.290	1.347	1.404	1.460	1.517	1.574	1.633	1.688	1.745	1.802
10.00	0.925	0.980	1.036	1.091	1.147	1.203	1.258	1.314	1.370	1.426	1.482	1.536	1.592	1.647	1.704	1.759
10.50	0.904	0.959	1.013	1.068	1.121	1.176	1.230	1.285	1.340	1.393	1.449	1.502	1.556	1.611	1.665	1.720
11.00	0.886	0.939	0.992	1.045	1.099	1.152	1.206	1.258	1.311	1.365	1.419	1.472	1.525	1.578	1.633	1.686
11.50	0.869	0.921	0.973	1.026	1.078	1.131	1.182	1.234	1.287	1.340	1.391	1.445	1.496	1.549	1.602	1.652
12.00	0.854	0.905	0.956	1.008	1.059	1.110	1.162	1.214	1.264	1.316	1.367	1.419	1.470	1.521	1.574	1.623
12.50	0.840	0.890	0.941	0.991	1.042	1.092	1.143	1.194	1.244	1.294	1.345	1.395	1.447	1.496	1.547	1.597

Curve: Very Inverse

Curve#:	17	18	19	20	21	22	23	24	25	26	27	28	29	30	31	32		
× P/U								Time to trip (seconds)										
13.00	0.827	0.877	0.926	0.976	1.027	1.076	1.126	1.176	1.224	1.275	1.324	1.374	1.424	1.474	1.523	1.574		
13.50	0.815	0.864	0.913	0.962	1.011	1.060	1.110	1.158	1.208	1.257	1.307	1.355	1.404	1.452	1.502	1.551		
14.00	0.804	0.853	0.901	0.950	0.998	1.046	1.094	1.144	1.191	1.240	1.288	1.337	1.386	1.433	1.482	1.530		
14.50	0.794	0.842	0.890	0.938	0.986	1.033	1.081	1.130	1.177	1.224	1.273	1.321	1.369	1.417	1.464	1.511		
15.00	0.785	0.833	0.879	0.927	0.974	1.022	1.069	1.116	1.163	1.211	1.257	1.305	1.352	1.399	1.447	1.494		
15.50	0.777	0.823	0.870	0.917	0.963	1.010	1.057	1.103	1.150	1.198	1.244	1.291	1.337	1.384	1.430	1.478		
16.00	0.769	0.815	0.861	0.907	0.953	0.999	1.046	1.092	1.138	1.185	1.231	1.277	1.324	1.369	1.415	1.462		
16.50	0.761	0.807	0.853	0.898	0.944	0.989	1.035	1.081	1.127	1.173	1.219	1.264	1.310	1.355	1.402	1.447		
17.00	0.754	0.799	0.845	0.890	0.935	0.980	1.026	1.071	1.117	1.162	1.207	1.253	1.299	1.343	1.388	1.433		
17.50	0.747	0.792	0.837	0.882	0.927	0.972	1.017	1.061	1.107	1.152	1.196	1.241	1.287	1.332	1.376	1.422		
18.00	0.741	0.785	0.830	0.874	0.919	0.964	1.009	1.053	1.098	1.143	1.187	1.231	1.276	1.321	1.365	1.409		
18.50	0.735	0.779	0.824	0.868	0.912	0.956	1.000	1.044	1.089	1.133	1.177	1.222	1.266	1.310	1.353	1.399		
19.00	0.730	0.774	0.817	0.861	0.905	0.949	0.993	1.036	1.080	1.125	1.168	1.212	1.255	1.300	1.343	1.388		
19.50	0.724	0.768	0.811	0.855	0.898	0.942	0.986	1.029	1.073	1.116	1.160	1.203	1.247	1.291	1.334	1.377		
20.00	0.719	0.762	0.805	0.849	0.892	0.935	0.979	1.022	1.066	1.109	1.152	1.195	1.238	1.282	1.324	1.369		

www.ElectricalPartManuals.com

CURVE INFORMATION AND TABLES



Curve: Extremely Inverse

Curve#:	1	2	3	4	5	6	7	8	9	10	11	12	13	14	15	16
× P/U																
	Time to trip (seconds)															
1.03	12.003	18.204	24.272	30.340	36.408	42.010	49.648	54.613	60.681	68.266	72.817	78.018	84.019	91.021	99.295	99.295
1.10	9.416	14.185	18.832	23.745	28.743	33.098	37.664	42.010	47.489	52.012	57.487	60.681	68.266	72.817	78.018	78.018
1.20	6.913	10.402	14.003	17.337	21.005	24.272	28.006	31.207	35.234	39.009	42.010	45.510	49.648	52.012	54.613	60.681
1.30	5.302	7.973	10.708	13.320	16.063	18.832	21.417	24.272	26.640	29.520	32.125	35.234	37.664	40.454	43.690	45.510
1.40	4.201	6.314	8.467	10.604	12.701	14.760	16.804	19.162	21.005	23.239	25.401	27.306	29.520	32.125	34.133	36.408
1.50	3.403	5.128	6.827	8.600	10.304	12.003	13.653	15.384	17.066	18.832	20.608	22.291	24.272	26.006	27.306	29.520
1.60	2.815	4.234	5.659	7.093	8.533	9.930	11.378	12.850	14.185	15.604	17.066	18.513	19.859	21.417	22.755	24.272
1.70	2.369	3.569	4.770	5.969	7.186	8.338	9.581	10.708	12.003	13.160	14.372	15.604	16.804	17.906	19.162	20.227
1.80	2.023	3.042	4.076	5.080	6.102	7.139	8.151	9.179	10.208	11.260	12.272	13.320	14.372	15.384	16.302	17.337
1.90	1.748	2.632	3.512	4.404	5.277	6.171	7.047	7.915	8.808	9.666	10.604	11.497	12.412	13.160	14.185	14.962
2.00	1.525	2.295	3.068	3.832	4.609	5.381	6.136	6.913	7.692	8.467	9.256	10.021	10.814	11.497	12.272	13.160
2.10	1.343	2.023	2.704	3.382	4.060	4.728	5.407	6.102	6.784	7.430	8.151	8.808	9.498	10.208	10.814	11.497
2.20	1.192	1.794	2.395	3.001	3.605	4.201	4.812	5.407	6.001	6.620	7.233	7.802	8.402	9.027	9.666	10.208
2.30	1.066	1.604	2.142	2.684	3.222	3.753	4.300	4.833	5.381	5.904	6.463	7.002	7.533	8.091	8.600	9.179
2.40	0.958	1.443	1.926	2.411	2.897	3.382	3.860	4.352	4.833	5.328	5.810	6.277	6.784	7.233	7.746	8.212
2.50	0.867	1.305	1.745	2.180	2.619	3.060	3.501	3.929	4.369	4.812	5.251	5.689	6.136	6.580	7.002	7.430
2.60	0.789	1.187	1.585	1.982	2.380	2.779	3.175	3.581	3.972	4.369	4.770	5.177	5.573	5.969	6.350	6.784
2.70	0.720	1.085	1.449	1.811	2.176	2.540	2.905	3.270	3.629	4.001	4.352	4.728	5.080	5.461	5.810	6.171
2.80	0.661	0.995	1.329	1.662	1.997	2.329	2.664	3.001	3.330	3.665	4.001	4.334	4.668	5.010	5.328	5.659
2.90	0.608	0.916	1.223	1.532	1.839	2.146	2.454	2.758	3.068	3.382	3.690	3.986	4.300	4.609	4.920	5.226
3.00	0.562	0.847	1.131	1.415	1.699	1.982	2.266	2.552	2.837	3.121	3.403	3.690	3.972	4.250	4.551	4.833
3.10	0.522	0.785	1.049	1.313	1.576	1.839	2.105	2.369	2.632	2.897	3.157	3.424	3.690	3.943	4.217	4.476
3.20	0.485	0.731	0.976	1.220	1.466	1.712	1.957	2.202	2.449	2.690	2.936	3.184	3.424	3.678	3.915	4.169
3.30	0.453	0.681	0.910	1.139	1.367	1.597	1.827	2.053	2.285	2.511	2.737	2.968	3.194	3.424	3.653	3.887
3.40	0.424	0.638	0.851	1.066	1.279	1.494	1.707	1.923	2.137	2.349	2.564	2.779	2.992	3.203	3.424	3.629
3.50	0.397	0.598	0.798	0.999	1.200	1.400	1.602	1.802	2.004	2.202	2.406	2.607	2.808	3.009	3.203	3.403
3.60	0.373	0.562	0.751	0.939	1.127	1.316	1.504	1.693	1.883	2.073	2.261	2.449	2.638	2.822	3.017	3.203
3.70	0.352	0.529	0.707	0.884	1.063	1.240	1.417	1.595	1.773	1.950	2.129	2.304	2.482	2.664	2.837	3.017
3.80	0.332	0.499	0.667	0.835	1.003	1.171	1.339	1.507	1.673	1.842	2.008	2.176	2.344	2.511	2.677	2.844
3.90	0.314	0.472	0.631	0.790	0.948	1.107	1.266	1.424	1.583	1.742	1.900	2.057	2.216	2.374	2.534	2.690
4.00	0.297	0.448	0.598	0.748	0.898	1.048	1.199	1.348	1.500	1.650	1.799	1.950	2.100	2.252	2.401	2.552
4.10	0.282	0.425	0.567	0.710	0.853	0.996	1.138	1.280	1.424	1.565	1.709	1.851	1.993	2.137	2.280	2.422
4.20	0.268	0.404	0.539	0.675	0.811	0.946	1.081	1.218	1.353	1.488	1.623	1.759	1.896	2.030	2.167	2.304
4.30	0.255	0.385	0.514	0.643	0.772	0.901	1.030	1.160	1.288	1.417	1.547	1.675	1.805	1.933	2.061	2.193
4.40	0.244	0.367	0.490	0.613	0.736	0.859	0.982	1.106	1.229	1.352	1.474	1.597	1.720	1.845	1.968	2.088
4.50	0.233	0.350	0.468	0.585	0.703	0.821	0.938	1.055	1.173	1.291	1.408	1.525	1.642	1.762	1.877	1.997
4.60	0.222	0.335	0.447	0.560	0.672	0.784	0.897	1.009	1.121	1.234	1.347	1.458	1.572	1.683	1.796	1.910
4.70	0.213	0.320	0.428	0.536	0.643	0.751	0.859	0.967	1.074	1.181	1.290	1.397	1.504	1.611	1.720	1.827
4.80	0.204	0.307	0.410	0.514	0.617	0.720	0.823	0.926	1.029	1.133	1.236	1.339	1.443	1.545	1.647	1.750
4.90	0.196	0.295	0.394	0.493	0.592	0.691	0.790	0.889	0.988	1.087	1.186	1.285	1.384	1.482	1.583	1.680
5.00	0.188	0.283	0.378	0.473	0.569	0.664	0.759	0.854	0.949	1.044	1.139	1.234	1.329	1.424	1.519	1.616
5.10	0.181	0.273	0.364	0.455	0.547	0.638	0.730	0.821	0.913	1.004	1.096	1.187	1.279	1.370	1.462	1.554
5.20	0.174	0.262	0.350	0.438	0.527	0.615	0.703	0.791	0.879	0.967	1.055	1.144	1.231	1.319	1.408	1.496
5.30	0.168	0.253	0.338	0.423	0.508	0.592	0.677	0.762	0.847	0.932	1.017	1.102	1.187	1.272	1.357	1.441
5.40	0.162	0.244	0.326	0.408	0.490	0.572	0.653	0.735	0.817	0.899	0.981	1.063	1.145	1.227	1.308	1.390
5.50	0.156	0.236	0.315	0.394	0.473	0.552	0.631	0.710	0.789	0.868	0.947	1.027	1.106	1.185	1.263	1.342
5.60	0.151	0.228	0.304	0.380	0.457	0.533	0.610	0.686	0.763	0.839	0.916	0.992	1.068	1.145	1.220	1.297
5.70	0.146	0.220	0.294	0.368	0.442	0.516	0.590	0.664	0.738	0.811	0.885	0.959	1.033	1.107	1.181	1.255
5.80	0.142	0.213	0.285	0.356	0.428	0.499	0.571	0.643	0.714	0.785	0.857	0.929	1.000	1.072	1.144	1.215
5.90	0.137	0.206	0.276	0.345	0.414	0.484	0.553	0.622	0.692	0.761	0.830	0.900	0.969	1.038	1.108	1.177
6.00	0.133	0.200	0.267	0.335	0.402	0.469	0.536	0.603	0.671	0.738	0.805	0.872	0.939	1.007	1.074	1.141
6.50	0.115	0.173	0.231	0.290	0.348	0.406	0.464	0.522	0.580	0.639	0.697	0.755	0.813	0.871	0.930	0.988
7.00	0.101	0.152	0.203	0.255	0.306	0.357	0.408	0.459	0.510	0.562	0.613	0.664	0.715	0.766	0.817	0.868
7.50	0.090	0.136	0.181	0.227	0.272	0.318	0.364	0.409	0.455	0.500	0.546	0.591	0.637	0.683	0.728	0.774
8.00	0.081	0.122	0.163	0.204	0.246	0.287	0.328	0.369	0.410	0.451	0.492	0.533	0.574	0.615	0.656	0.697
8.50	0.074	0.111	0.149	0.186	0.224	0.261	0.298	0.336	0.373	0.410	0.448	0.485	0.523	0.560	0.598	0.635
9.00	0.068	0.102	0.137	0.171	0.205	0.240	0.274	0.308	0.343	0.377	0.411	0.446	0.480	0.514	0.549	0.583
9.50	0.063	0.095	0.126	0.158	0.190	0.222	0.254	0.285	0.317	0.349	0.381	0.412	0.444	0.476	0.508	0.540
10.00	0.059	0.088	0.118	0.147	0.177	0.207	0.236	0.266	0.296	0.325	0.355	0.384	0.414	0.444	0.473	0.503
10.50	0.055	0.083	0.110	0.138	0.166	0.194	0.222	0.249	0.277	0.305	0.333	0.360	0.388	0.416	0.444	0.471
11.00	0.052	0.078	0.104	0.130	0.157	0.183	0.209	0.235	0.261	0.287	0.314	0.340	0.366	0.392	0.418	0.444
11.50	0.049	0.074	0.099	0.123	0.148	0.173	0.198	0.223	0.247	0.272	0.297	0.322	0.347	0.371	0.396	0.421
12.00	0.047	0.070	0.094	0.117	0.141	0.165	0.188	0.212	0.235	0.259	0.283	0.306	0.330	0.353	0.377	0.401
12.50	0.045	0.067	0.090	0.112	0.135	0.157	0.180	0.202	0.225	0.247	0.270	0.293	0.315	0.338	0.360	0.383

Curve: Extremely Inverse

Curve#:	1	2	3	4	5	6	7	8	9	10	11	12	13	14	15	16		
× P/U																		
								Time to trip (seconds)										
13.00	0.043	0.064	0.086	0.108	0.129	0.151	0.172	0.194	0.216	0.237	0.259	0.280	0.302	0.324	0.345	0.367		
13.50	0.041	0.062	0.083	0.103	0.124	0.145	0.166	0.187	0.207	0.228	0.249	0.270	0.290	0.311	0.332	0.353		
14.00	0.040	0.060	0.080	0.100	0.120	0.140	0.160	0.180	0.200	0.220	0.240	0.260	0.280	0.300	0.320	0.340		
14.50	0.038	0.058	0.077	0.097	0.116	0.135	0.155	0.174	0.193	0.213	0.232	0.252	0.271	0.290	0.310	0.329		
15.00	0.037	0.056	0.075	0.094	0.112	0.131	0.150	0.169	0.188	0.206	0.225	0.244	0.263	0.282	0.300	0.319		
15.50	0.036	0.054	0.073	0.091	0.109	0.127	0.146	0.164	0.182	0.201	0.219	0.237	0.255	0.274	0.292	0.310		
16.00	0.035	0.053	0.071	0.089	0.106	0.124	0.142	0.160	0.177	0.195	0.213	0.231	0.249	0.266	0.284	0.302		
16.50	0.034	0.052	0.069	0.086	0.104	0.121	0.138	0.156	0.173	0.190	0.208	0.225	0.242	0.260	0.277	0.294		
17.00	0.034	0.050	0.067	0.084	0.101	0.118	0.135	0.152	0.169	0.186	0.203	0.220	0.237	0.254	0.271	0.288		
17.50	0.033	0.049	0.066	0.083	0.099	0.116	0.132	0.149	0.165	0.182	0.199	0.215	0.232	0.248	0.265	0.282		
18.00	0.032	0.048	0.065	0.081	0.097	0.113	0.130	0.146	0.162	0.178	0.195	0.211	0.227	0.243	0.260	0.276		
18.50	0.032	0.047	0.063	0.079	0.095	0.111	0.127	0.143	0.159	0.175	0.191	0.207	0.223	0.239	0.255	0.271		
19.00	0.031	0.047	0.062	0.078	0.094	0.109	0.125	0.141	0.156	0.172	0.188	0.203	0.219	0.235	0.250	0.266		
19.50	0.030	0.046	0.061	0.077	0.092	0.107	0.123	0.138	0.154	0.169	0.184	0.200	0.215	0.231	0.246	0.261		
20.00	0.030	0.045	0.060	0.075	0.091	0.106	0.121	0.136	0.151	0.166	0.182	0.197	0.212	0.227	0.242	0.257		

www.ElectricalPartManuals.com

CURVE INFORMATION AND TABLES



Curve: Extremely Inverse

Curve#:	17	18	19	20	21	22	23	24	25	26	27	28	29	30	31	32
× P/U	Time to trip (seconds)															
1.03	109.225	121.361	121.361	121.361	136.531	136.531	156.036	156.036	156.036	156.036	182.042	182.042	182.042	182.042	182.042	218.450
1.10	84.019	91.021	99.295	99.295	109.225	109.225	109.225	121.361	121.361	121.361	136.531	136.531	136.531	156.036	156.036	156.036
1.20	64.250	68.266	68.266	72.817	78.018	78.018	84.019	91.021	91.021	91.021	99.295	99.295	109.225	109.225	109.225	121.361
1.30	47.489	52.012	54.613	57.487	57.487	60.681	64.250	68.266	68.266	72.817	72.817	78.018	78.018	84.019	84.019	91.021
1.40	37.664	40.454	42.010	43.690	47.489	49.648	52.012	52.012	54.613	57.487	60.681	60.681	64.250	64.250	68.266	68.266
1.50	31.207	33.098	34.133	36.408	37.664	39.009	42.010	43.690	45.510	45.510	47.489	49.648	52.012	54.613	54.613	57.487
1.60	25.401	27.306	28.743	29.520	31.207	33.098	34.133	35.234	36.408	39.009	40.454	42.010	42.010	43.690	45.510	47.489
1.70	21.417	22.755	23.745	25.401	26.640	27.306	28.743	30.340	31.207	32.125	33.098	35.234	36.408	37.664	37.664	39.009
1.80	18.513	19.504	20.608	21.417	22.291	23.745	24.272	25.401	26.640	27.306	28.743	29.520	30.340	32.125	33.098	34.133
1.90	15.830	16.804	17.617	18.513	19.504	20.227	21.005	21.845	22.755	23.745	24.824	25.401	26.640	27.306	28.006	28.743
2.00	13.826	14.563	15.384	16.063	17.066	17.617	18.513	19.162	19.859	20.608	21.417	22.291	23.239	23.745	24.824	25.401
2.10	12.136	12.850	13.485	14.185	14.962	15.604	16.302	17.066	17.617	18.204	18.832	19.504	20.227	21.005	21.845	22.291
2.20	10.814	11.378	12.003	12.701	13.320	13.826	14.372	14.962	15.604	16.302	16.804	17.337	18.204	18.513	19.162	19.859
2.30	9.666	10.208	10.708	11.260	11.872	12.412	12.850	13.485	14.003	14.563	15.170	15.604	16.063	16.804	17.337	17.617
2.40	8.738	9.179	9.666	10.208	10.604	11.145	11.620	12.136	12.555	13.003	13.485	14.003	14.563	14.962	15.384	16.063
2.50	7.858	8.338	8.738	9.179	9.666	10.113	10.502	10.923	11.378	11.872	12.272	12.701	13.160	13.653	14.003	14.372
2.60	7.186	7.585	7.973	8.338	8.738	9.179	9.581	9.930	10.304	10.708	11.145	11.497	12.003	12.412	12.701	13.160
2.70	6.540	6.913	7.282	7.638	7.973	8.338	8.738	9.102	9.416	9.840	10.208	10.502	10.923	11.260	11.620	12.003
2.80	6.001	6.350	6.660	7.002	7.331	7.692	8.031	8.338	8.669	9.027	9.335	9.666	10.021	10.304	10.708	11.033
2.90	5.516	5.841	6.136	6.463	6.742	7.047	7.380	7.692	7.973	8.275	8.600	8.880	9.256	9.498	9.840	10.113
3.00	5.104	5.407	5.689	5.969	6.241	6.540	6.827	7.093	7.380	7.692	7.973	8.212	8.533	8.808	9.102	9.335
3.10	4.749	5.010	5.277	5.544	5.810	6.068	6.314	6.580	6.869	7.093	7.380	7.638	7.915	8.151	8.402	8.669
3.20	4.404	4.648	4.898	5.152	5.381	5.630	5.872	6.136	6.387	6.620	6.869	7.093	7.331	7.585	7.858	8.091
3.30	4.106	4.334	4.570	4.791	5.033	5.251	5.489	5.719	5.936	6.171	6.387	6.620	6.869	7.093	7.331	7.533
3.40	3.846	4.060	4.283	4.495	4.708	4.920	5.128	5.354	5.573	5.779	6.001	6.206	6.425	6.620	6.827	7.047
3.50	3.605	3.806	4.016	4.217	4.404	4.609	4.812	5.010	5.201	5.407	5.601	5.810	6.001	6.206	6.425	6.620
3.60	3.392	3.581	3.766	3.957	4.153	4.334	4.513	4.708	4.898	5.080	5.277	5.461	5.659	5.841	6.035	6.206
3.70	3.194	3.371	3.546	3.728	3.901	4.076	4.267	4.440	4.609	4.791	4.965	5.152	5.328	5.516	5.689	5.872
3.80	3.017	3.184	3.350	3.523	3.690	3.860	4.016	4.185	4.352	4.522	4.688	4.854	5.033	5.201	5.354	5.544
3.90	2.852	3.009	3.166	3.330	3.490	3.641	3.806	3.957	4.122	4.283	4.440	4.589	4.749	4.920	5.080	5.226
4.00	2.704	2.852	3.001	3.157	3.300	3.456	3.605	3.753	3.901	4.060	4.201	4.352	4.513	4.648	4.812	4.965
4.10	2.564	2.704	2.852	2.992	3.139	3.280	3.424	3.558	3.703	3.846	3.986	4.137	4.283	4.422	4.570	4.708
4.20	2.438	2.576	2.710	2.844	2.976	3.112	3.251	3.382	3.523	3.653	3.793	3.929	4.060	4.201	4.334	4.476
4.30	2.319	2.449	2.582	2.710	2.837	2.968	3.094	3.222	3.350	3.479	3.617	3.741	3.873	4.001	4.122	4.250
4.40	2.211	2.334	2.460	2.582	2.704	2.830	2.952	3.077	3.194	3.320	3.446	3.569	3.690	3.819	3.943	4.060
4.50	2.113	2.229	2.349	2.466	2.582	2.704	2.815	2.936	3.051	3.175	3.290	3.403	3.523	3.641	3.753	3.873
4.60	2.019	2.133	2.247	2.359	2.471	2.582	2.697	2.808	2.920	3.034	3.148	3.260	3.371	3.479	3.593	3.703
4.70	1.933	2.042	2.150	2.257	2.364	2.471	2.582	2.690	2.793	2.905	3.009	3.121	3.222	3.330	3.446	3.546
4.80	1.854	1.957	2.061	2.163	2.266	2.369	2.471	2.576	2.677	2.786	2.890	2.992	3.094	3.194	3.300	3.403
4.90	1.779	1.880	1.979	2.077	2.176	2.276	2.374	2.471	2.570	2.671	2.772	2.867	2.968	3.068	3.166	3.260
5.00	1.709	1.805	1.900	1.997	2.092	2.185	2.280	2.374	2.471	2.564	2.664	2.758	2.852	2.944	3.042	3.139
5.10	1.645	1.736	1.827	1.920	2.012	2.100	2.193	2.285	2.374	2.466	2.558	2.651	2.744	2.837	2.928	3.017
5.20	1.583	1.673	1.759	1.848	1.937	2.023	2.113	2.202	2.290	2.374	2.466	2.552	2.638	2.731	2.815	2.905
5.30	1.525	1.611	1.696	1.782	1.867	1.950	2.034	2.121	2.207	2.290	2.374	2.460	2.546	2.632	2.717	2.801
5.40	1.472	1.554	1.635	1.717	1.799	1.883	1.964	2.045	2.129	2.211	2.290	2.374	2.454	2.534	2.619	2.704
5.50	1.422	1.500	1.581	1.660	1.736	1.817	1.896	1.975	2.053	2.133	2.211	2.290	2.369	2.449	2.528	2.607
5.60	1.374	1.451	1.528	1.604	1.680	1.756	1.833	1.910	1.986	2.061	2.137	2.216	2.290	2.369	2.444	2.523
5.70	1.329	1.402	1.476	1.551	1.625	1.699	1.773	1.845	1.920	1.993	2.069	2.142	2.216	2.290	2.364	2.438
5.80	1.287	1.359	1.430	1.500	1.572	1.645	1.715	1.788	1.858	1.930	2.000	2.073	2.146	2.216	2.290	2.359
5.90	1.245	1.316	1.384	1.454	1.523	1.592	1.662	1.731	1.799	1.870	1.940	2.008	2.077	2.146	2.216	2.285
6.00	1.208	1.276	1.342	1.409	1.476	1.545	1.611	1.678	1.745	1.814	1.880	1.947	2.015	2.080	2.150	2.216
6.50	1.046	1.104	1.162	1.220	1.279	1.337	1.395	1.452	1.511	1.569	1.628	1.686	1.745	1.802	1.861	1.920
7.00	0.919	0.971	1.022	1.073	1.124	1.176	1.226	1.277	1.329	1.379	1.432	1.482	1.534	1.585	1.635	1.686
7.50	0.819	0.865	0.910	0.956	1.001	1.047	1.092	1.138	1.183	1.229	1.275	1.321	1.365	1.411	1.456	1.502
8.00	0.739	0.780	0.821	0.861	0.903	0.944	0.985	1.026	1.067	1.108	1.149	1.190	1.231	1.272	1.313	1.353
8.50	0.672	0.710	0.747	0.784	0.822	0.859	0.897	0.934	0.971	1.009	1.046	1.084	1.120	1.158	1.195	1.233
9.00	0.617	0.652	0.686	0.720	0.755	0.789	0.823	0.857	0.892	0.926	0.961	0.995	1.029	1.064	1.098	1.132
9.50	0.571	0.603	0.635	0.667	0.698	0.730	0.762	0.794	0.826	0.857	0.889	0.921	0.952	0.984	1.016	1.048
10.00	0.532	0.562	0.592	0.621	0.651	0.681	0.710	0.740	0.769	0.799	0.829	0.858	0.888	0.917	0.947	0.977
10.50	0.499	0.527	0.555	0.583	0.610	0.638	0.666	0.693	0.721	0.749	0.777	0.804	0.833	0.860	0.888	0.916
11.00	0.471	0.497	0.523	0.549	0.575	0.601	0.628	0.654	0.680	0.706	0.733	0.759	0.785	0.811	0.837	0.863
11.50	0.446	0.471	0.495	0.520	0.545	0.570	0.595	0.620	0.644	0.669	0.694	0.719	0.744	0.768	0.793	0.818
12.00	0.424	0.448	0.471	0.495	0.519	0.542	0.566	0.589	0.613	0.637	0.660	0.684	0.707	0.731	0.754	0.778
12.50	0.405	0.428	0.450	0.473	0.495	0.518	0.540	0.563	0.586	0.608	0.631	0.653	0.676	0.698	0.721	0.744

Curve: Extremely Inverse

Curve#:	17	18	19	20	21	22	23	24	25	26	27	28	29	30	31	32
× P/U																
	Time to trip (seconds)															
13.00	0.389	0.410	0.432	0.453	0.475	0.496	0.518	0.540	0.561	0.583	0.604	0.626	0.648	0.669	0.691	0.712
13.50	0.374	0.394	0.415	0.436	0.457	0.478	0.498	0.519	0.540	0.561	0.582	0.602	0.623	0.644	0.665	0.685
14.00	0.360	0.380	0.401	0.421	0.441	0.461	0.481	0.501	0.521	0.541	0.561	0.581	0.601	0.621	0.641	0.661
14.50	0.349	0.368	0.387	0.407	0.426	0.445	0.465	0.484	0.504	0.523	0.543	0.562	0.581	0.601	0.620	0.639
15.00	0.338	0.357	0.376	0.394	0.413	0.432	0.451	0.470	0.488	0.507	0.526	0.545	0.564	0.582	0.601	0.620
15.50	0.328	0.347	0.365	0.383	0.401	0.420	0.438	0.456	0.474	0.493	0.511	0.529	0.547	0.566	0.584	0.602
16.00	0.320	0.338	0.355	0.373	0.391	0.409	0.426	0.444	0.462	0.480	0.498	0.515	0.533	0.551	0.569	0.586
16.50	0.312	0.329	0.347	0.364	0.381	0.398	0.416	0.433	0.451	0.468	0.485	0.503	0.520	0.537	0.555	0.572
17.00	0.305	0.322	0.339	0.355	0.372	0.389	0.406	0.423	0.440	0.457	0.474	0.491	0.508	0.525	0.542	0.559
17.50	0.298	0.315	0.331	0.348	0.364	0.381	0.398	0.414	0.431	0.447	0.464	0.481	0.497	0.514	0.530	0.547
18.00	0.292	0.308	0.325	0.341	0.357	0.373	0.390	0.406	0.422	0.438	0.455	0.471	0.487	0.503	0.520	0.536
18.50	0.287	0.303	0.319	0.334	0.350	0.366	0.382	0.398	0.414	0.430	0.446	0.462	0.478	0.494	0.510	0.526
19.00	0.282	0.297	0.313	0.328	0.344	0.360	0.375	0.391	0.407	0.423	0.438	0.454	0.470	0.485	0.501	0.516
19.50	0.277	0.292	0.308	0.323	0.338	0.354	0.369	0.385	0.400	0.415	0.431	0.446	0.462	0.477	0.492	0.508
20.00	0.273	0.288	0.303	0.318	0.333	0.348	0.364	0.379	0.394	0.409	0.424	0.439	0.455	0.470	0.485	0.500

www.ElectricalPartManuals.com

CURVE INFORMATION AND TABLES



Curve: IEC A

Curve #:	1	2	3	4	5	6	7	8	9	10	11	12	13	14	15	16
x P/U	Time to trip (seconds)															
1.03	11.872	23.745	35.234	47.489	60.681	72.817	84.019	91.021	109.225	121.361	136.531	136.531	156.036	156.036	182.042	182.042
1.10	3.665	7.331	11.033	14.760	18.204	21.845	25.401	29.520	33.098	36.408	40.454	43.690	47.489	52.012	54.613	57.487
1.20	1.916	3.832	5.749	7.638	9.581	11.497	13.485	15.384	17.337	19.162	21.005	22.755	24.824	26.640	28.743	30.340
1.30	1.330	2.664	3.986	5.328	6.660	7.973	9.335	10.604	12.003	13.320	14.563	16.063	17.337	18.513	19.859	21.417
1.40	1.036	2.073	3.112	4.153	5.177	6.206	7.233	8.275	9.335	10.402	11.378	12.412	13.485	14.563	15.604	16.549
1.50	0.860	1.720	2.582	3.435	4.300	5.152	6.035	6.869	7.746	8.600	9.498	10.304	11.145	12.003	12.850	13.826
1.60	0.741	1.482	2.225	2.968	3.703	4.440	5.177	5.936	6.660	7.430	8.151	8.880	9.666	10.402	11.145	11.872
1.70	0.656	1.313	1.968	2.626	3.280	3.943	4.589	5.251	5.904	6.580	7.233	7.858	8.533	9.179	9.840	10.502
1.80	0.592	1.183	1.776	2.369	2.960	3.546	4.137	4.728	5.328	5.904	6.501	7.093	7.692	8.275	8.880	9.498
1.90	0.542	1.084	1.625	2.167	2.710	3.251	3.793	4.334	4.876	5.407	5.969	6.501	7.047	7.585	8.151	8.669
2.00	0.501	1.003	1.504	2.004	2.505	3.009	3.512	4.016	4.513	5.010	5.516	6.001	6.501	7.002	7.533	8.031
2.10	0.468	0.937	1.404	1.873	2.339	2.808	3.280	3.741	4.217	4.688	5.152	5.630	6.102	6.540	7.002	7.481
2.20	0.440	0.881	1.321	1.762	2.202	2.645	3.085	3.523	3.957	4.404	4.854	5.277	5.719	6.171	6.620	7.047
2.30	0.417	0.833	1.250	1.668	2.084	2.499	2.920	3.330	3.753	4.169	4.589	5.010	5.407	5.841	6.241	6.660
2.40	0.396	0.793	1.189	1.585	1.982	2.380	2.772	3.166	3.569	3.957	4.352	4.749	5.152	5.544	5.936	6.350
2.50	0.378	0.757	1.135	1.515	1.893	2.271	2.651	3.026	3.403	3.779	4.169	4.551	4.920	5.302	5.689	6.068
2.60	0.363	0.726	1.088	1.451	1.814	2.176	2.540	2.905	3.260	3.629	3.986	4.352	4.708	5.080	5.434	5.810
2.70	0.349	0.698	1.046	1.395	1.745	2.092	2.444	2.793	3.139	3.490	3.832	4.185	4.532	4.876	5.226	5.573
2.80	0.336	0.673	1.009	1.345	1.683	2.019	2.354	2.690	3.026	3.361	3.703	4.030	4.369	4.708	5.057	5.381
2.90	0.325	0.651	0.976	1.300	1.625	1.950	2.276	2.601	2.928	3.251	3.581	3.901	4.234	4.551	4.876	5.201
3.00	0.315	0.630	0.946	1.260	1.576	1.890	2.207	2.523	2.837	3.148	3.467	3.779	4.091	4.404	4.728	5.033
3.10	0.306	0.612	0.918	1.223	1.530	1.836	2.142	2.449	2.751	3.060	3.361	3.665	3.972	4.283	4.589	4.898
3.20	0.297	0.595	0.892	1.190	1.488	1.785	2.080	2.380	2.677	2.976	3.270	3.569	3.873	4.169	4.458	4.749
3.30	0.290	0.579	0.869	1.158	1.449	1.739	2.026	2.319	2.607	2.897	3.184	3.479	3.766	4.060	4.352	4.628
3.40	0.283	0.565	0.847	1.130	1.413	1.696	1.979	2.261	2.540	2.822	3.112	3.392	3.678	3.957	4.234	4.513
3.50	0.276	0.552	0.827	1.103	1.379	1.655	1.930	2.207	2.482	2.758	3.034	3.310	3.581	3.860	4.137	4.422
3.60	0.270	0.539	0.809	1.079	1.348	1.618	1.890	2.159	2.427	2.697	2.968	3.241	3.512	3.779	4.045	4.317
3.70	0.264	0.528	0.792	1.056	1.321	1.585	1.848	2.113	2.374	2.638	2.905	3.166	3.435	3.703	3.957	4.217
3.80	0.259	0.517	0.776	1.034	1.294	1.551	1.811	2.069	2.329	2.588	2.844	3.103	3.361	3.617	3.887	4.137
3.90	0.254	0.507	0.761	1.015	1.269	1.521	1.776	2.030	2.285	2.534	2.793	3.042	3.300	3.546	3.806	4.060
4.00	0.249	0.498	0.747	0.996	1.245	1.494	1.742	1.993	2.243	2.488	2.737	2.984	3.241	3.490	3.741	3.986
4.10	0.245	0.489	0.734	0.978	1.223	1.468	1.712	1.957	2.202	2.444	2.690	2.936	3.175	3.424	3.665	3.915
4.20	0.240	0.481	0.721	0.961	1.202	1.443	1.683	1.923	2.163	2.406	2.645	2.882	3.130	3.361	3.605	3.846
4.30	0.236	0.473	0.709	0.946	1.182	1.419	1.655	1.893	2.129	2.364	2.601	2.837	3.077	3.310	3.546	3.779
4.40	0.233	0.466	0.698	0.931	1.163	1.397	1.630	1.861	2.096	2.329	2.558	2.793	3.026	3.260	3.490	3.728
4.50	0.229	0.458	0.688	0.917	1.146	1.376	1.604	1.833	2.065	2.290	2.523	2.751	2.976	3.213	3.435	3.665
4.60	0.226	0.452	0.678	0.903	1.130	1.355	1.581	1.808	2.034	2.257	2.482	2.710	2.936	3.166	3.392	3.617
4.70	0.223	0.445	0.668	0.891	1.113	1.335	1.558	1.782	2.004	2.225	2.449	2.671	2.897	3.121	3.340	3.558
4.80	0.220	0.439	0.659	0.879	1.098	1.318	1.538	1.756	1.975	2.198	2.416	2.638	2.852	3.077	3.290	3.512
4.90	0.217	0.433	0.650	0.867	1.084	1.300	1.517	1.734	1.950	2.167	2.385	2.601	2.815	3.034	3.251	3.467
5.00	0.214	0.428	0.642	0.856	1.070	1.283	1.498	1.712	1.926	2.142	2.354	2.570	2.779	2.992	3.213	3.424
5.10	0.211	0.423	0.634	0.845	1.056	1.269	1.480	1.691	1.903	2.113	2.324	2.534	2.744	2.960	3.166	3.382
5.20	0.209	0.418	0.626	0.835	1.044	1.253	1.462	1.670	1.880	2.088	2.295	2.505	2.717	2.920	3.130	3.340
5.30	0.206	0.413	0.619	0.826	1.032	1.238	1.445	1.650	1.858	2.065	2.271	2.477	2.684	2.890	3.094	3.300
5.40	0.204	0.408	0.612	0.816	1.020	1.224	1.428	1.633	1.836	2.042	2.243	2.449	2.651	2.859	3.060	3.260
5.50	0.202	0.404	0.605	0.807	1.009	1.211	1.413	1.616	1.817	2.019	2.220	2.422	2.626	2.822	3.026	3.232
5.60	0.200	0.399	0.599	0.799	0.998	1.198	1.399	1.597	1.796	1.997	2.198	2.395	2.594	2.793	2.992	3.194
5.70	0.198	0.395	0.593	0.790	0.988	1.186	1.383	1.581	1.779	1.975	2.176	2.369	2.570	2.765	2.968	3.166
5.80	0.196	0.391	0.587	0.782	0.978	1.173	1.369	1.565	1.762	1.957	2.150	2.349	2.546	2.737	2.936	3.130
5.90	0.194	0.387	0.581	0.775	0.968	1.162	1.355	1.549	1.742	1.937	2.129	2.324	2.517	2.710	2.905	3.103
6.00	0.192	0.384	0.575	0.768	0.959	1.151	1.343	1.534	1.726	1.920	2.109	2.304	2.494	2.684	2.874	3.068
6.50	0.184	0.367	0.551	0.734	0.918	1.101	1.285	1.468	1.652	1.836	2.019	2.202	2.385	2.570	2.751	2.936
7.00	0.176	0.353	0.529	0.706	0.882	1.058	1.234	1.411	1.588	1.765	1.940	2.117	2.295	2.471	2.645	2.822
7.50	0.170	0.340	0.511	0.681	0.851	1.022	1.191	1.362	1.532	1.701	1.873	2.042	2.211	2.385	2.552	2.724
8.00	0.165	0.330	0.494	0.659	0.824	0.989	1.153	1.319	1.484	1.647	1.814	1.979	2.142	2.309	2.471	2.638
8.50	0.160	0.320	0.480	0.640	0.800	0.961	1.120	1.280	1.441	1.602	1.762	1.920	2.080	2.243	2.401	2.564
9.00	0.156	0.312	0.467	0.623	0.779	0.935	1.091	1.247	1.402	1.558	1.715	1.870	2.026	2.180	2.339	2.494
9.50	0.152	0.304	0.456	0.608	0.760	0.912	1.064	1.216	1.369	1.519	1.673	1.823	1.975	2.129	2.280	2.433
10.00	0.149	0.297	0.446	0.594	0.743	0.891	1.039	1.189	1.337	1.486	1.633	1.782	1.930	2.080	2.229	2.374
10.50	0.145	0.291	0.436	0.582	0.727	0.872	1.018	1.163	1.308	1.454	1.599	1.745	1.890	2.034	2.180	2.324
11.00	0.142	0.285	0.427	0.570	0.712	0.855	0.997	1.140	1.282	1.424	1.567	1.709	1.851	1.993	2.137	2.280
11.50	0.140	0.280	0.419	0.559	0.699	0.839	0.979	1.119	1.258	1.399	1.538	1.678	1.817	1.957	2.096	2.238
12.00	0.137	0.275	0.412	0.549	0.687	0.824	0.961	1.099	1.237	1.374	1.511	1.647	1.785	1.923	2.061	2.198
12.50	0.135	0.270	0.405	0.540	0.675	0.811	0.946	1.080	1.216	1.352	1.486	1.621	1.756	1.893	2.026	2.163

Curve: IEC A

Curve #:	1	2	3	4	5	6	7	8	9	10	11	12	13	14	15	16
x P/U	Time to trip (seconds)															
13.00	0.133	0.266	0.399	0.532	0.665	0.798	0.931	1.064	1.196	1.330	1.462	1.597	1.728	1.861	1.993	2.129
13.50	0.131	0.262	0.393	0.524	0.655	0.786	0.917	1.048	1.180	1.310	1.441	1.572	1.704	1.833	1.964	2.096
14.00	0.129	0.258	0.387	0.517	0.646	0.775	0.904	1.033	1.162	1.291	1.420	1.549	1.678	1.808	1.937	2.065
14.50	0.127	0.255	0.382	0.510	0.637	0.764	0.892	1.019	1.147	1.275	1.402	1.530	1.657	1.785	1.913	2.038
15.00	0.126	0.252	0.377	0.503	0.629	0.755	0.880	1.006	1.132	1.258	1.384	1.509	1.635	1.762	1.886	2.012
15.50	0.124	0.248	0.373	0.497	0.621	0.746	0.870	0.994	1.118	1.243	1.367	1.490	1.616	1.739	1.864	1.986
16.00	0.123	0.246	0.368	0.491	0.614	0.737	0.859	0.982	1.104	1.227	1.350	1.474	1.597	1.720	1.842	1.964
16.50	0.121	0.243	0.364	0.485	0.607	0.728	0.850	0.971	1.092	1.214	1.335	1.456	1.578	1.699	1.820	1.944
17.00	0.120	0.240	0.360	0.480	0.600	0.720	0.840	0.961	1.080	1.200	1.321	1.441	1.560	1.680	1.802	1.920
17.50	0.119	0.238	0.356	0.475	0.594	0.713	0.832	0.951	1.070	1.189	1.307	1.426	1.545	1.662	1.782	1.900
18.00	0.118	0.235	0.353	0.471	0.588	0.706	0.823	0.941	1.058	1.176	1.294	1.411	1.530	1.647	1.765	1.883
18.50	0.116	0.233	0.350	0.466	0.583	0.699	0.816	0.932	1.048	1.164	1.282	1.399	1.515	1.630	1.748	1.864
19.00	0.115	0.231	0.346	0.462	0.577	0.693	0.808	0.923	1.038	1.155	1.270	1.384	1.500	1.616	1.731	1.845
19.50	0.114	0.229	0.343	0.457	0.572	0.686	0.801	0.915	1.029	1.144	1.258	1.372	1.486	1.602	1.715	1.830
20.00	0.113	0.227	0.340	0.453	0.567	0.680	0.794	0.907	1.020	1.134	1.247	1.360	1.474	1.588	1.701	1.814

www.ElectricalPartMan.com

CURVE INFORMATION AND TABLES



Curve: IEC A

Curve #:	17	18	19	20	21	22	23	24	25	26	27	28	29	30	31	32
x P/U	Time to Trip (seconds)															
1.03	218.450	218.450	218.450	218.450	273.063	273.063	273.063	273.063	273.063	273.063	364.083	364.083	364.083	364.083	364.083	364.083
1.10	60.681	64.250	68.266	72.817	78.018	78.018	84.019	91.021	91.021	99.295	99.295	99.295	109.225	109.225	109.225	121.361
1.20	32.125	34.133	36.408	37.664	40.454	42.010	43.690	45.510	47.489	49.648	52.012	54.613	54.613	57.487	60.681	60.681
1.30	22.755	23.745	25.401	26.640	28.006	29.520	30.340	32.125	33.098	34.133	36.408	37.664	39.009	40.454	42.010	42.010
1.40	17.617	18.513	19.859	20.608	21.845	22.755	23.745	24.824	26.006	26.640	28.006	28.743	30.340	31.207	32.125	33.098
1.50	14.563	15.384	16.302	17.066	18.204	18.832	19.859	20.608	21.417	22.291	23.239	24.272	24.824	26.006	26.640	27.306
1.60	12.555	13.320	14.003	14.760	15.604	16.302	17.066	17.906	18.513	19.162	19.859	20.608	21.417	22.291	22.755	23.745
1.70	11.145	11.872	12.412	13.160	13.826	14.372	15.170	15.830	16.302	17.066	17.617	18.513	19.162	19.859	20.227	21.005
1.80	10.021	10.604	11.260	11.872	12.412	13.003	13.653	14.185	14.760	15.384	16.063	16.549	17.066	17.617	18.204	18.832
1.90	9.179	9.752	10.304	10.814	11.378	11.872	12.412	13.003	13.485	14.003	14.563	15.170	15.604	16.302	16.804	17.337
2.00	8.533	9.027	9.498	10.021	10.502	11.033	11.497	12.003	12.555	13.003	13.485	14.003	14.563	14.962	15.604	16.063
2.10	7.973	8.402	8.880	9.335	9.840	10.304	10.814	11.260	11.745	12.136	12.701	13.160	13.653	14.003	14.563	14.962
2.20	7.481	7.915	8.338	8.808	9.256	9.666	10.113	10.604	11.033	11.497	11.872	12.272	12.701	13.160	13.653	14.003
2.30	7.093	7.481	7.915	8.338	8.738	9.179	9.581	10.021	10.402	10.814	11.260	11.620	12.136	12.555	12.850	13.320
2.40	6.742	7.139	7.533	7.915	8.338	8.738	9.102	9.498	9.930	10.304	10.708	11.145	11.497	11.872	12.272	12.701
2.50	6.425	6.827	7.186	7.585	7.973	8.338	8.738	9.102	9.498	9.840	10.208	10.604	10.923	11.378	11.745	12.136
2.60	6.171	6.540	6.913	7.233	7.638	7.973	8.338	8.738	9.102	9.416	9.752	10.113	10.502	10.923	11.260	11.620
2.70	5.936	6.277	6.620	6.957	7.331	7.692	8.031	8.402	8.738	9.102	9.416	9.752	10.113	10.502	10.814	11.145
2.80	5.719	6.068	6.387	6.742	7.047	7.380	7.746	8.091	8.402	8.738	9.102	9.416	9.752	10.113	10.402	10.814
2.90	5.516	5.841	6.171	6.501	6.827	7.139	7.481	7.802	8.151	8.467	8.808	9.102	9.416	9.752	10.113	10.402
3.00	5.354	5.659	6.001	6.314	6.620	6.913	7.233	7.585	7.858	8.212	8.533	8.808	9.102	9.416	9.752	10.113
3.10	5.201	5.516	5.810	6.102	6.425	6.742	7.047	7.331	7.638	7.973	8.275	8.533	8.880	9.179	9.498	9.752
3.20	5.057	5.354	5.659	5.936	6.241	6.540	6.827	7.139	7.430	7.746	8.031	8.338	8.600	8.953	9.256	9.498
3.30	4.920	5.226	5.516	5.779	6.068	6.387	6.660	6.957	7.233	7.533	7.802	8.091	8.402	8.669	8.953	9.256
3.40	4.812	5.080	5.381	5.659	5.936	6.206	6.501	6.784	7.047	7.331	7.638	7.915	8.212	8.467	8.738	9.027
3.50	4.688	4.965	5.251	5.516	5.779	6.068	6.350	6.620	6.913	7.186	7.430	7.746	7.973	8.275	8.533	8.808
3.60	4.589	4.854	5.128	5.407	5.659	5.936	6.206	6.463	6.742	7.002	7.282	7.533	7.802	8.091	8.338	8.600
3.70	4.495	4.749	5.010	5.277	5.544	5.810	6.068	6.350	6.620	6.869	7.139	7.380	7.638	7.915	8.212	8.467
3.80	4.404	4.648	4.920	5.177	5.434	5.689	5.936	6.206	6.463	6.742	7.002	7.233	7.481	7.746	8.031	8.275
3.90	4.317	4.570	4.812	5.080	5.328	5.573	5.841	6.102	6.350	6.580	6.869	7.093	7.380	7.585	7.858	8.091
4.00	4.234	4.476	4.728	4.987	5.226	5.489	5.719	5.969	6.241	6.463	6.742	6.957	7.233	7.481	7.692	7.973
4.10	4.153	4.404	4.648	4.898	5.128	5.381	5.630	5.872	6.102	6.350	6.620	6.827	7.093	7.331	7.585	7.802
4.20	4.091	4.334	4.570	4.812	5.057	5.277	5.516	5.779	6.001	6.241	6.501	6.742	6.957	7.233	7.430	7.692
4.30	4.016	4.250	4.495	4.728	4.965	5.201	5.434	5.689	5.904	6.136	6.387	6.620	6.869	7.093	7.331	7.585
4.40	3.957	4.185	4.422	4.648	4.898	5.128	5.354	5.573	5.810	6.068	6.277	6.501	6.742	7.002	7.233	7.430
4.50	3.901	4.122	4.352	4.589	4.812	5.033	5.277	5.489	5.719	5.969	6.206	6.425	6.660	6.869	7.093	7.331
4.60	3.846	4.060	4.283	4.513	4.749	4.965	5.201	5.434	5.659	5.872	6.102	6.314	6.540	6.784	7.002	7.233
4.70	3.779	4.001	4.234	4.458	4.668	4.898	5.128	5.354	5.573	5.779	6.001	6.241	6.463	6.660	6.913	7.139
4.80	3.728	3.957	4.169	4.387	4.609	4.833	5.057	5.277	5.489	5.719	5.936	6.136	6.387	6.580	6.827	7.047
4.90	3.690	3.901	4.122	4.334	4.551	4.770	4.987	5.201	5.407	5.630	5.841	6.068	6.277	6.501	6.701	6.957
5.00	3.641	3.846	4.060	4.283	4.495	4.708	4.920	5.128	5.354	5.573	5.779	6.001	6.206	6.425	6.620	6.827
5.10	3.593	3.806	4.016	4.234	4.440	4.648	4.854	5.080	5.277	5.489	5.719	5.904	6.136	6.350	6.540	6.742
5.20	3.546	3.753	3.972	4.169	4.387	4.589	4.812	5.010	5.226	5.434	5.630	5.841	6.068	6.277	6.463	6.701
5.30	3.512	3.715	3.915	4.122	4.334	4.532	4.749	4.942	5.152	5.354	5.573	5.779	6.001	6.206	6.387	6.620
5.40	3.467	3.678	3.873	4.076	4.283	4.495	4.688	4.898	5.104	5.302	5.516	5.719	5.904	6.136	6.314	6.540
5.50	3.435	3.629	3.832	4.030	4.234	4.440	4.648	4.854	5.057	5.251	5.461	5.659	5.841	6.068	6.241	6.463
5.60	3.392	3.593	3.793	4.001	4.201	4.387	4.589	4.791	4.987	5.201	5.381	5.601	5.779	6.001	6.206	6.387
5.70	3.361	3.558	3.753	3.957	4.153	4.352	4.551	4.749	4.942	5.128	5.328	5.544	5.719	5.936	6.136	6.314
5.80	3.330	3.523	3.715	3.915	4.106	4.300	4.495	4.688	4.898	5.080	5.277	5.489	5.659	5.872	6.068	6.277
5.90	3.290	3.490	3.678	3.873	4.060	4.267	4.458	4.648	4.833	5.033	5.226	5.434	5.630	5.810	6.001	6.206
6.00	3.260	3.456	3.641	3.832	4.030	4.217	4.404	4.609	4.791	4.987	5.177	5.381	5.573	5.749	5.936	6.136
6.50	3.121	3.300	3.490	3.665	3.860	4.030	4.217	4.404	4.589	4.770	4.965	5.128	5.328	5.516	5.689	5.872
7.00	3.001	3.175	3.350	3.523	3.703	3.887	4.060	4.234	4.404	4.589	4.770	4.942	5.104	5.302	5.461	5.630
7.50	2.897	3.068	3.232	3.403	3.569	3.741	3.915	4.091	4.250	4.422	4.589	4.770	4.942	5.104	5.277	5.434
8.00	2.801	2.968	3.130	3.300	3.456	3.629	3.793	3.957	4.122	4.283	4.458	4.609	4.791	4.942	5.104	5.277
8.50	2.724	2.882	3.042	3.203	3.361	3.523	3.678	3.846	4.001	4.169	4.317	4.476	4.648	4.812	4.965	5.128
9.00	2.651	2.808	2.960	3.121	3.270	3.424	3.581	3.741	3.901	4.045	4.201	4.369	4.513	4.668	4.833	4.987
9.50	2.582	2.737	2.890	3.042	3.194	3.340	3.501	3.653	3.806	3.957	4.106	4.250	4.404	4.551	4.708	4.854
10.00	2.523	2.671	2.822	2.968	3.121	3.270	3.413	3.569	3.715	3.860	4.016	4.153	4.300	4.458	4.609	4.749
10.50	2.471	2.619	2.765	2.905	3.051	3.194	3.340	3.490	3.629	3.779	3.929	4.076	4.217	4.369	4.513	4.648
11.00	2.422	2.564	2.710	2.852	2.992	3.139	3.280	3.424	3.558	3.703	3.846	3.986	4.137	4.267	4.422	4.551
11.50	2.380	2.517	2.658	2.793	2.936	3.077	3.213	3.361	3.501	3.641	3.779	3.915	4.060	4.201	4.334	4.476
12.00	2.334	2.471	2.613	2.744	2.882	3.026	3.157	3.300	3.435	3.569	3.715	3.846	3.986	4.122	4.267	4.404
12.50	2.295	2.433	2.564	2.704	2.837	2.976	3.103	3.241	3.382	3.512	3.653	3.779	3.915	4.060	4.185	4.317
13.00	2.261	2.395	2.528	2.658	2.793	2.928	3.060	3.194	3.320	3.456	3.593	3.728	3.860	3.986	4.122	4.250

Curve: IEC A

Curve #:	17	18	19	20	21	22	23	24	25	26	27	28	29	30	31	32
x P/U	Time to Trip (seconds)															
13.50	2.229	2.359	2.488	2.619	2.751	2.882	3.017	3.148	3.280	3.403	3.535	3.665	3.806	3.929	4.060	4.185
14.00	2.198	2.324	2.454	2.582	2.710	2.844	2.968	3.103	3.232	3.361	3.490	3.617	3.741	3.873	4.001	4.137
14.50	2.167	2.295	2.422	2.546	2.677	2.801	2.928	3.060	3.184	3.310	3.446	3.569	3.690	3.819	3.943	4.076
15.00	2.137	2.266	2.390	2.517	2.638	2.765	2.890	3.017	3.148	3.270	3.392	3.523	3.653	3.779	3.901	4.030
15.50	2.113	2.238	2.359	2.482	2.607	2.731	2.859	2.984	3.103	3.232	3.350	3.479	3.605	3.728	3.846	3.972
16.00	2.088	2.211	2.334	2.454	2.576	2.704	2.822	2.944	3.068	3.194	3.310	3.435	3.558	3.678	3.806	3.929
16.50	2.065	2.185	2.304	2.427	2.552	2.671	2.793	2.913	3.034	3.157	3.280	3.403	3.523	3.641	3.766	3.887
17.00	2.042	2.163	2.280	2.401	2.523	2.645	2.758	2.882	3.001	3.121	3.241	3.361	3.479	3.605	3.728	3.846
17.50	2.019	2.137	2.257	2.374	2.494	2.613	2.731	2.852	2.968	3.085	3.213	3.330	3.446	3.569	3.678	3.806
18.00	2.000	2.117	2.234	2.354	2.471	2.588	2.704	2.822	2.944	3.060	3.175	3.290	3.413	3.523	3.641	3.766
18.50	1.979	2.096	2.216	2.329	2.449	2.564	2.677	2.793	2.913	3.026	3.148	3.260	3.382	3.490	3.617	3.728
19.00	1.961	2.077	2.193	2.309	2.422	2.540	2.651	2.772	2.882	3.001	3.112	3.232	3.350	3.467	3.581	3.690
19.50	1.944	2.057	2.171	2.285	2.401	2.517	2.632	2.744	2.859	2.976	3.085	3.203	3.320	3.435	3.546	3.665
20.00	1.926	2.042	2.154	2.266	2.380	2.494	2.607	2.724	2.837	2.944	3.060	3.175	3.290	3.403	3.512	3.629

www.ElectricalPartMan.com

CURVE INFORMATION AND TABLES



Curve: IEC B

Curve #:	1	2	3	4	5	6	7	8	9	10	11	12	13	14	15	16
x P/U	Time to Trip (seconds)															
1.03	22.291	45.510	68.266	91.021	109.225	136.531	156.036	182.042	218.450	218.450	273.063	273.063	273.063	364.083	364.083	364.083
1.10	6.742	13.485	20.227	27.306	34.133	40.454	47.489	54.613	60.681	68.266	72.817	84.019	91.021	91.021	99.295	109.225
1.20	3.371	6.742	10.113	13.485	16.804	20.227	23.745	27.306	30.340	34.133	37.664	40.454	43.690	47.489	49.648	54.613
1.30	2.252	4.495	6.742	9.027	11.260	13.485	15.830	17.906	20.227	22.291	24.824	27.306	29.520	31.207	34.133	36.408
1.40	1.688	3.371	5.057	6.742	8.467	10.113	11.872	13.485	15.170	16.804	18.513	20.227	21.845	23.745	25.401	27.306
1.50	1.350	2.697	4.045	5.407	6.742	8.091	9.416	10.814	12.136	13.485	14.760	16.302	17.617	18.832	20.227	21.417
1.60	1.125	2.252	3.371	4.495	5.630	6.742	7.858	9.027	10.113	11.260	12.412	13.485	14.563	15.830	16.804	17.906
1.70	0.964	1.930	2.890	3.860	4.812	5.779	6.742	7.692	8.669	9.666	10.604	11.620	12.555	13.485	14.372	15.384
1.80	0.843	1.688	2.528	3.371	4.217	5.057	5.904	6.742	7.585	8.467	9.256	10.113	10.923	11.872	12.701	13.485
1.90	0.750	1.500	2.252	3.001	3.753	4.495	5.251	6.001	6.742	7.481	8.275	9.027	9.752	10.502	11.260	12.003
2.00	0.675	1.350	2.026	2.697	3.371	4.045	4.728	5.407	6.068	6.742	7.430	8.091	8.808	9.416	10.113	10.814
2.10	0.614	1.227	1.842	2.454	3.068	3.678	4.300	4.920	5.516	6.136	6.742	7.380	7.973	8.600	9.179	9.840
2.20	0.562	1.125	1.688	2.252	2.815	3.371	3.943	4.495	5.057	5.630	6.171	6.742	7.331	7.858	8.467	9.027
2.30	0.519	1.038	1.558	2.077	2.594	3.112	3.629	4.153	4.668	5.201	5.719	6.241	6.742	7.282	7.802	8.338
2.40	0.482	0.964	1.447	1.930	2.411	2.890	3.371	3.860	4.334	4.812	5.302	5.779	6.277	6.742	7.233	7.692
2.50	0.450	0.900	1.350	1.799	2.252	2.697	3.148	3.605	4.045	4.495	4.942	5.407	5.841	6.314	6.742	7.186
2.60	0.422	0.843	1.266	1.688	2.109	2.528	2.952	3.371	3.793	4.217	4.648	5.057	5.489	5.904	6.314	6.742
2.70	0.397	0.794	1.191	1.588	1.986	2.385	2.779	3.175	3.569	3.972	4.369	4.770	5.152	5.573	5.969	6.350
2.80	0.375	0.750	1.125	1.500	1.873	2.252	2.626	3.001	3.371	3.753	4.122	4.495	4.876	5.251	5.630	6.001
2.90	0.355	0.711	1.066	1.420	1.776	2.133	2.488	2.844	3.194	3.558	3.915	4.267	4.628	4.965	5.328	5.689
3.00	0.338	0.675	1.012	1.350	1.688	2.026	2.364	2.697	3.034	3.371	3.715	4.045	4.387	4.728	5.057	5.407
3.10	0.321	0.643	0.964	1.285	1.606	1.930	2.252	2.570	2.890	3.213	3.535	3.860	4.185	4.495	4.812	5.152
3.20	0.307	0.614	0.920	1.227	1.534	1.842	2.146	2.454	2.758	3.068	3.371	3.678	3.986	4.300	4.609	4.920
3.30	0.293	0.587	0.880	1.174	1.468	1.762	2.053	2.349	2.638	2.936	3.232	3.523	3.819	4.106	4.404	4.688
3.40	0.281	0.562	0.843	1.125	1.406	1.688	1.968	2.252	2.528	2.815	3.094	3.371	3.653	3.943	4.217	4.495
3.50	0.270	0.540	0.810	1.080	1.350	1.621	1.890	2.159	2.433	2.697	2.968	3.241	3.512	3.779	4.045	4.317
3.60	0.260	0.519	0.779	1.038	1.299	1.558	1.817	2.077	2.339	2.594	2.859	3.112	3.371	3.629	3.901	4.153
3.70	0.250	0.500	0.750	1.000	1.250	1.500	1.750	2.000	2.252	2.499	2.751	3.001	3.251	3.501	3.753	4.001
3.80	0.241	0.482	0.723	0.964	1.206	1.447	1.688	1.930	2.171	2.411	2.651	2.890	3.130	3.371	3.617	3.860
3.90	0.233	0.466	0.698	0.931	1.163	1.397	1.630	1.861	2.096	2.329	2.558	2.793	3.026	3.260	3.490	3.728
4.00	0.225	0.450	0.675	0.900	1.125	1.350	1.576	1.799	2.026	2.252	2.477	2.697	2.928	3.148	3.371	3.605
4.10	0.218	0.436	0.653	0.871	1.089	1.307	1.523	1.742	1.961	2.176	2.395	2.613	2.830	3.051	3.270	3.479
4.20	0.211	0.422	0.633	0.843	1.054	1.266	1.476	1.688	1.900	2.109	2.319	2.528	2.744	2.952	3.166	3.371
4.30	0.205	0.409	0.614	0.818	1.023	1.227	1.432	1.638	1.842	2.045	2.252	2.454	2.658	2.867	3.068	3.270
4.40	0.199	0.397	0.596	0.794	0.993	1.191	1.390	1.588	1.788	1.986	2.185	2.385	2.582	2.779	2.976	3.175
4.50	0.193	0.386	0.579	0.771	0.964	1.157	1.350	1.543	1.736	1.930	2.121	2.314	2.505	2.697	2.890	3.085
4.60	0.188	0.375	0.562	0.750	0.938	1.125	1.313	1.500	1.688	1.873	2.061	2.252	2.438	2.626	2.815	3.001
4.70	0.182	0.365	0.547	0.730	0.912	1.094	1.277	1.460	1.642	1.823	2.008	2.189	2.369	2.552	2.737	2.920
4.80	0.178	0.355	0.533	0.711	0.888	1.066	1.244	1.420	1.599	1.776	1.954	2.133	2.309	2.488	2.664	2.844
4.90	0.173	0.346	0.519	0.692	0.865	1.038	1.211	1.384	1.558	1.731	1.903	2.077	2.252	2.422	2.594	2.772
5.00	0.169	0.338	0.506	0.675	0.843	1.012	1.181	1.350	1.519	1.688	1.858	2.026	2.193	2.364	2.528	2.697
5.10	0.165	0.329	0.494	0.658	0.823	0.988	1.152	1.318	1.482	1.647	1.811	1.975	2.142	2.304	2.471	2.632
5.20	0.161	0.321	0.482	0.643	0.804	0.964	1.125	1.285	1.447	1.606	1.767	1.930	2.088	2.252	2.411	2.570
5.30	0.157	0.314	0.471	0.628	0.785	0.942	1.099	1.255	1.413	1.569	1.726	1.883	2.042	2.198	2.354	2.511
5.40	0.153	0.307	0.460	0.614	0.767	0.920	1.074	1.227	1.381	1.534	1.688	1.842	1.993	2.146	2.299	2.454
5.50	0.150	0.300	0.450	0.600	0.750	0.900	1.050	1.200	1.350	1.500	1.650	1.799	1.950	2.100	2.252	2.401
5.60	0.147	0.293	0.440	0.587	0.734	0.880	1.028	1.174	1.321	1.468	1.613	1.762	1.906	2.053	2.202	2.349
5.70	0.144	0.287	0.431	0.575	0.718	0.861	1.006	1.149	1.293	1.435	1.581	1.723	1.867	2.012	2.154	2.299
5.80	0.141	0.281	0.422	0.562	0.703	0.843	0.984	1.125	1.266	1.406	1.547	1.688	1.830	1.968	2.109	2.252
5.90	0.138	0.276	0.413	0.551	0.689	0.827	0.964	1.102	1.240	1.377	1.515	1.652	1.791	1.930	2.065	2.202
6.00	0.135	0.270	0.405	0.540	0.675	0.810	0.945	1.080	1.215	1.350	1.484	1.621	1.756	1.890	2.026	2.159
6.50	0.123	0.245	0.368	0.491	0.614	0.737	0.859	0.982	1.104	1.227	1.350	1.472	1.595	1.717	1.842	1.964
7.00	0.112	0.225	0.338	0.450	0.562	0.675	0.787	0.900	1.012	1.125	1.237	1.350	1.462	1.576	1.688	1.799
7.50	0.104	0.208	0.312	0.415	0.519	0.623	0.727	0.831	0.934	1.038	1.143	1.247	1.350	1.454	1.558	1.662
8.00	0.096	0.193	0.289	0.386	0.482	0.579	0.675	0.771	0.868	0.964	1.060	1.157	1.254	1.350	1.447	1.543
8.50	0.090	0.180	0.270	0.360	0.450	0.540	0.630	0.720	0.810	0.900	0.990	1.080	1.169	1.260	1.350	1.439
9.00	0.084	0.169	0.253	0.338	0.422	0.506	0.591	0.675	0.760	0.843	0.928	1.012	1.097	1.181	1.266	1.350
9.50	0.079	0.159	0.238	0.318	0.397	0.477	0.556	0.635	0.715	0.794	0.874	0.953	1.032	1.112	1.191	1.270
10.00	0.075	0.150	0.225	0.300	0.375	0.450	0.525	0.600	0.675	0.750	0.825	0.900	0.975	1.050	1.125	1.200
10.50	0.071	0.142	0.213	0.284	0.355	0.426	0.497	0.568	0.639	0.711	0.782	0.853	0.924	0.995	1.066	1.137
11.00	0.068	0.135	0.202	0.270	0.338	0.405	0.472	0.540	0.607	0.675	0.743	0.810	0.877	0.945	1.012	1.080
11.50	0.064	0.129	0.193	0.257	0.321	0.386	0.450	0.514	0.579	0.643	0.707	0.771	0.836	0.900	0.964	1.028
12.00	0.061	0.123	0.184	0.245	0.307	0.368	0.430	0.491	0.552	0.614	0.675	0.737	0.798	0.859	0.920	0.982
12.50	0.059	0.117	0.176	0.235	0.293	0.352	0.411	0.470	0.528	0.587	0.646	0.704	0.763	0.822	0.880	0.939
13.00	0.056	0.112	0.169	0.225	0.281	0.338	0.394	0.450	0.506	0.562	0.619	0.675	0.731	0.787	0.843	0.900

Curve: IEC B

Curve #:	1	2	3	4	5	6	7	8	9	10	11	12	13	14	15	16
x P/U	Time to Trip (seconds)															
13.50	0.054	0.108	0.162	0.216	0.270	0.324	0.378	0.432	0.486	0.540	0.594	0.648	0.702	0.756	0.810	0.864
14.00	0.052	0.104	0.156	0.208	0.260	0.312	0.363	0.415	0.467	0.519	0.571	0.623	0.675	0.727	0.779	0.831
14.50	0.050	0.100	0.150	0.200	0.250	0.300	0.350	0.400	0.450	0.500	0.550	0.600	0.650	0.700	0.750	0.800
15.00	0.048	0.096	0.145	0.193	0.241	0.289	0.338	0.386	0.434	0.482	0.530	0.579	0.627	0.675	0.723	0.771
15.50	0.047	0.093	0.140	0.186	0.233	0.279	0.326	0.372	0.419	0.466	0.512	0.559	0.605	0.652	0.698	0.745
16.00	0.045	0.090	0.135	0.180	0.225	0.270	0.315	0.360	0.405	0.450	0.495	0.540	0.585	0.630	0.675	0.720
16.50	0.044	0.087	0.131	0.174	0.218	0.261	0.305	0.348	0.392	0.436	0.479	0.523	0.566	0.610	0.653	0.697
17.00	0.042	0.084	0.127	0.169	0.211	0.253	0.295	0.338	0.380	0.422	0.464	0.506	0.548	0.591	0.633	0.675
17.50	0.041	0.082	0.123	0.164	0.205	0.245	0.286	0.327	0.368	0.409	0.450	0.491	0.532	0.573	0.614	0.654
18.00	0.040	0.079	0.119	0.159	0.199	0.238	0.278	0.318	0.357	0.397	0.437	0.477	0.516	0.556	0.596	0.635
18.50	0.039	0.077	0.116	0.154	0.193	0.231	0.270	0.309	0.347	0.386	0.424	0.463	0.501	0.540	0.579	0.617
19.00	0.037	0.075	0.112	0.150	0.188	0.225	0.262	0.300	0.338	0.375	0.412	0.450	0.487	0.525	0.562	0.600
19.50	0.036	0.073	0.109	0.146	0.182	0.219	0.255	0.292	0.328	0.365	0.401	0.438	0.474	0.511	0.547	0.584
20.00	0.036	0.071	0.107	0.142	0.178	0.213	0.249	0.284	0.320	0.355	0.391	0.426	0.462	0.497	0.533	0.568

www.ElectricalPartMan.com

CURVE INFORMATION AND TABLES



Curve: IEC B

Curve #:	17	18	19	20	21	22	23	24	25	26	27	28	29	30	31	32
x P/U	Time to Trip (seconds)															
1.03	364.083	364.083	364.083	546.125	546.125	546.125	546.125	546.125	546.125	546.125	546.125	546.125	546.125	546.125	546.125	546.125
1.10	109.225	121.361	121.361	136.531	136.531	156.036	156.036	156.036	182.042	182.042	182.042	182.042	182.042	218.450	218.450	218.450
1.20	57.487	60.681	64.250	68.266	72.817	72.817	78.018	84.019	84.019	91.021	91.021	91.021	99.295	99.295	109.225	109.225
1.30	37.664	40.454	42.010	45.510	47.489	49.648	52.012	54.613	57.487	57.487	60.681	64.250	64.250	68.266	68.266	72.817
1.40	28.743	30.340	32.125	34.133	35.234	37.664	39.009	40.454	42.010	43.690	45.510	47.489	49.648	49.648	52.012	54.613
1.50	22.755	24.272	25.401	27.306	28.006	29.520	31.207	32.125	34.133	35.234	36.408	37.664	39.009	40.454	42.010	43.690
1.60	19.162	20.227	21.417	22.291	23.745	24.824	26.006	27.306	28.006	29.520	30.340	31.207	33.098	34.133	35.234	36.408
1.70	16.302	17.337	18.204	19.162	20.227	21.417	22.291	23.239	24.272	24.824	26.006	27.306	28.006	28.743	29.520	31.207
1.80	14.372	15.170	16.063	16.804	17.617	18.513	19.504	20.227	21.005	21.845	22.755	23.745	24.272	25.401	26.006	27.306
1.90	12.701	13.485	14.185	14.962	15.830	16.549	17.337	17.906	18.832	19.504	20.227	21.005	21.845	22.291	23.239	23.745
2.00	11.497	12.136	12.850	13.485	14.185	14.760	15.604	16.302	16.804	17.617	18.204	18.832	19.504	20.227	21.005	21.417
2.10	10.402	11.033	11.620	12.272	12.850	13.485	14.185	14.760	15.384	16.063	16.549	17.066	17.906	18.513	19.162	19.504
2.20	9.581	10.113	10.708	11.260	11.872	12.412	13.003	13.485	14.003	14.563	15.170	15.830	16.302	16.804	17.337	17.906
2.30	8.808	9.335	9.840	10.402	10.923	11.378	12.003	12.412	13.003	13.485	14.003	14.563	14.962	15.604	16.063	16.549
2.40	8.212	8.669	9.179	9.666	10.113	10.604	11.145	11.620	12.003	12.555	13.003	13.485	14.003	14.372	14.962	15.384
2.50	7.638	8.091	8.533	9.027	9.416	9.930	10.304	10.814	11.260	11.745	12.136	12.555	13.003	13.485	14.003	14.372
2.60	7.186	7.585	8.031	8.467	8.880	9.256	9.666	10.113	10.502	10.923	11.378	11.872	12.272	12.701	13.003	13.485
2.70	6.742	7.139	7.533	7.915	8.338	8.738	9.102	9.498	9.930	10.304	10.708	11.145	11.497	11.872	12.272	12.701
2.80	6.387	6.742	7.139	7.481	7.858	8.275	8.600	9.027	9.335	9.752	10.113	10.502	10.923	11.260	11.620	12.003
2.90	6.035	6.387	6.742	7.093	7.481	7.802	8.151	8.533	8.880	9.256	9.581	9.930	10.304	10.708	11.033	11.378
3.00	5.749	6.068	6.425	6.742	7.093	7.430	7.746	8.091	8.467	8.808	9.102	9.416	9.752	10.113	10.502	10.814
3.10	5.461	5.779	6.102	6.425	6.742	7.093	7.380	7.692	8.031	8.338	8.669	9.027	9.335	9.666	9.930	10.304
3.20	5.226	5.516	5.841	6.136	6.425	6.742	7.047	7.380	7.692	7.973	8.275	8.600	8.880	9.179	9.498	9.840
3.30	4.987	5.277	5.573	5.872	6.171	6.463	6.742	7.047	7.331	7.638	7.915	8.212	8.533	8.808	9.102	9.416
3.40	4.791	5.057	5.354	5.630	5.904	6.171	6.463	6.742	7.047	7.331	7.585	7.858	8.151	8.467	8.738	9.027
3.50	4.589	4.854	5.128	5.407	5.659	5.936	6.206	6.463	6.742	7.002	7.282	7.585	7.858	8.091	8.402	8.669
3.60	4.422	4.668	4.942	5.201	5.461	5.719	5.969	6.241	6.501	6.742	7.002	7.282	7.533	7.802	8.031	8.338
3.70	4.250	4.495	4.749	5.010	5.251	5.489	5.749	6.001	6.241	6.501	6.742	7.002	7.233	7.481	7.746	7.973
3.80	4.091	4.334	4.589	4.812	5.057	5.302	5.544	5.779	6.035	6.277	6.501	6.742	7.002	7.233	7.481	7.692
3.90	3.957	4.185	4.422	4.648	4.898	5.128	5.354	5.573	5.810	6.068	6.277	6.501	6.742	7.002	7.233	7.430
4.00	3.819	4.045	4.283	4.495	4.728	4.942	5.177	5.407	5.630	5.841	6.068	6.314	6.540	6.742	6.957	7.186
4.10	3.703	3.915	4.137	4.352	4.570	4.791	5.010	5.226	5.434	5.659	5.872	6.102	6.314	6.540	6.742	6.957
4.20	3.581	3.793	4.001	4.217	4.422	4.648	4.854	5.057	5.277	5.489	5.689	5.904	6.102	6.314	6.540	6.742
4.30	3.479	3.678	3.887	4.091	4.300	4.495	4.708	4.920	5.104	5.328	5.516	5.719	5.936	6.136	6.350	6.540
4.40	3.371	3.569	3.766	3.972	4.169	4.369	4.570	4.770	4.965	5.152	5.354	5.573	5.749	5.969	6.171	6.350
4.50	3.280	3.467	3.665	3.860	4.045	4.250	4.440	4.628	4.812	5.010	5.201	5.407	5.601	5.779	5.969	6.171
4.60	3.184	3.371	3.558	3.753	3.943	4.122	4.317	4.495	4.688	4.876	5.057	5.251	5.434	5.630	5.810	6.001
4.70	3.103	3.280	3.467	3.653	3.832	4.016	4.201	4.387	4.570	4.749	4.920	5.104	5.302	5.461	5.659	5.841
4.80	3.017	3.194	3.371	3.558	3.728	3.915	4.091	4.267	4.440	4.628	4.791	4.965	5.152	5.328	5.516	5.689
4.90	2.944	3.112	3.290	3.456	3.629	3.806	3.986	4.153	4.334	4.495	4.668	4.854	5.010	5.201	5.354	5.544
5.00	2.867	3.034	3.203	3.371	3.546	3.715	3.887	4.045	4.217	4.387	4.551	4.728	4.898	5.057	5.226	5.407
5.10	2.801	2.960	3.130	3.290	3.456	3.617	3.793	3.957	4.122	4.283	4.440	4.609	4.770	4.942	5.104	5.277
5.20	2.731	2.890	3.051	3.213	3.371	3.535	3.703	3.860	4.016	4.185	4.334	4.495	4.668	4.812	4.987	5.152
5.30	2.671	2.822	2.984	3.139	3.300	3.456	3.605	3.766	3.929	4.076	4.234	4.387	4.551	4.708	4.876	5.033
5.40	2.607	2.758	2.913	3.068	3.222	3.371	3.523	3.678	3.832	3.986	4.137	4.300	4.440	4.609	4.749	4.920
5.50	2.552	2.697	2.852	3.001	3.148	3.300	3.446	3.605	3.753	3.901	4.045	4.201	4.352	4.495	4.648	4.791
5.60	2.494	2.638	2.786	2.936	3.085	3.232	3.371	3.523	3.665	3.819	3.957	4.106	4.250	4.404	4.551	4.688
5.70	2.444	2.582	2.731	2.874	3.017	3.157	3.300	3.446	3.593	3.728	3.873	4.016	4.169	4.300	4.458	4.589
5.80	2.390	2.528	2.671	2.815	2.952	3.094	3.232	3.371	3.512	3.653	3.793	3.943	4.076	4.217	4.352	4.495
5.90	2.344	2.482	2.619	2.758	2.890	3.034	3.166	3.310	3.446	3.581	3.715	3.860	4.001	4.137	4.267	4.404
6.00	2.295	2.433	2.564	2.697	2.837	2.968	3.103	3.241	3.371	3.512	3.641	3.779	3.915	4.045	4.185	4.317
6.50	2.084	2.211	2.334	2.454	2.576	2.697	2.822	2.944	3.068	3.194	3.310	3.435	3.558	3.678	3.806	3.929
7.00	1.913	2.026	2.137	2.252	2.364	2.477	2.588	2.697	2.815	2.928	3.034	3.148	3.260	3.371	3.490	3.605
7.50	1.765	1.870	1.972	2.077	2.180	2.285	2.390	2.494	2.594	2.697	2.801	2.905	3.009	3.112	3.222	3.320
8.00	1.640	1.736	1.833	1.930	2.026	2.121	2.220	2.314	2.411	2.505	2.601	2.697	2.793	2.890	2.992	3.085
8.50	1.530	1.621	1.709	1.799	1.890	1.979	2.069	2.159	2.252	2.339	2.433	2.523	2.613	2.697	2.793	2.882
9.00	1.435	1.519	1.604	1.688	1.773	1.858	1.940	2.026	2.109	2.193	2.280	2.364	2.449	2.528	2.613	2.697
9.50	1.350	1.430	1.509	1.588	1.668	1.748	1.827	1.906	1.986	2.065	2.146	2.225	2.304	2.385	2.460	2.540
10.00	1.275	1.350	1.426	1.500	1.576	1.650	1.726	1.799	1.873	1.950	2.026	2.100	2.176	2.252	2.324	2.401
10.50	1.208	1.279	1.350	1.420	1.492	1.563	1.635	1.704	1.776	1.848	1.920	1.990	2.061	2.133	2.202	2.276
11.00	1.147	1.215	1.282	1.350	1.417	1.484	1.551	1.621	1.688	1.756	1.823	1.890	1.957	2.026	2.092	2.159
11.50	1.093	1.157	1.222	1.285	1.350	1.415	1.478	1.543	1.606	1.673	1.736	1.799	1.864	1.930	1.993	2.057
12.00	1.043	1.104	1.166	1.227	1.288	1.350	1.411	1.472	1.534	1.595	1.657	1.717	1.779	1.842	1.903	1.964
12.50	0.997	1.056	1.116	1.174	1.233	1.291	1.350	1.409	1.468	1.525	1.585	1.642	1.701	1.762	1.820	1.877
13.00	0.956	1.012	1.069	1.125	1.181	1.237	1.294	1.350	1.406	1.462	1.519	1.576	1.630	1.688	1.745	1.799

Curve: IEC B

Curve #:	17	18	19	20	21	22	23	24	25	26	27	28	29	30	31	32
x P/U	Time to Trip (seconds)															
13.50	0.918	0.972	1.026	1.080	1.134	1.189	1.243	1.296	1.350	1.404	1.458	1.513	1.567	1.621	1.675	1.728
14.00	0.883	0.934	0.987	1.038	1.090	1.143	1.194	1.247	1.299	1.350	1.402	1.454	1.507	1.558	1.609	1.662
14.50	0.850	0.900	0.950	1.000	1.050	1.100	1.150	1.200	1.250	1.300	1.350	1.400	1.451	1.500	1.549	1.599
15.00	0.819	0.868	0.916	0.964	1.012	1.060	1.109	1.157	1.206	1.254	1.302	1.350	1.399	1.447	1.494	1.543
15.50	0.791	0.838	0.884	0.931	0.978	1.024	1.071	1.117	1.163	1.211	1.257	1.303	1.350	1.397	1.443	1.490
16.00	0.765	0.810	0.855	0.900	0.945	0.990	1.035	1.080	1.125	1.169	1.215	1.260	1.305	1.350	1.395	1.439
16.50	0.741	0.784	0.827	0.871	0.915	0.958	1.002	1.045	1.089	1.132	1.176	1.219	1.263	1.307	1.350	1.393
17.00	0.717	0.760	0.801	0.843	0.886	0.928	0.970	1.012	1.054	1.097	1.139	1.181	1.223	1.266	1.308	1.350
17.50	0.695	0.737	0.777	0.818	0.859	0.900	0.941	0.982	1.023	1.064	1.104	1.145	1.186	1.227	1.269	1.310
18.00	0.675	0.715	0.754	0.794	0.834	0.874	0.913	0.953	0.993	1.032	1.072	1.112	1.151	1.191	1.231	1.270
18.50	0.656	0.694	0.733	0.771	0.810	0.849	0.887	0.926	0.964	1.003	1.041	1.080	1.119	1.157	1.196	1.234
19.00	0.638	0.675	0.712	0.750	0.787	0.825	0.863	0.900	0.938	0.975	1.012	1.050	1.088	1.125	1.162	1.200
19.50	0.620	0.657	0.693	0.730	0.766	0.803	0.839	0.876	0.912	0.949	0.985	1.022	1.058	1.094	1.131	1.168
20.00	0.604	0.639	0.675	0.711	0.746	0.782	0.817	0.853	0.888	0.924	0.959	0.995	1.030	1.066	1.101	1.137

www.ElectricalPartManufacturing.com

CURVE INFORMATION AND TABLES



Curve: IEC C

Curve #: x P/U	1	2	3	4	5	6	7	8	9	10	11	12	13	14	15	16
	Time to Trip (seconds)															
1.03	64.250	136.531	182.042	273.063	364.083	364.083	546.125	546.125	546.125	546.125	1092.250	1092.250	1092.250	1092.250	1092.250	1092.250
1.10	19.162	37.664	57.487	78.018	99.295	109.225	136.531	156.036	182.042	182.042	218.450	218.450	273.063	273.063	273.063	273.063
1.20	9.102	18.204	27.306	36.408	45.510	54.613	64.250	72.817	84.019	91.021	99.295	109.225	121.361	121.361	136.531	136.531
1.30	5.810	11.620	17.337	23.239	28.743	35.234	40.454	45.510	52.012	57.487	64.250	68.266	78.018	84.019	84.019	91.021
1.40	4.169	8.338	12.555	16.549	21.005	24.824	29.520	33.098	37.664	42.010	45.510	49.648	54.613	57.487	64.250	68.266
1.50	3.203	6.387	9.581	12.850	16.063	19.162	22.291	25.401	28.743	32.125	35.234	39.009	42.010	45.510	47.489	52.012
1.60	2.564	5.128	7.692	10.304	12.850	15.384	17.906	20.608	23.239	25.401	28.006	31.207	33.098	36.408	39.009	40.454
1.70	2.117	4.234	6.350	8.467	10.604	12.701	14.760	16.804	19.162	21.005	23.239	25.401	27.306	29.520	32.125	34.133
1.80	1.785	3.569	5.354	7.139	8.953	10.708	12.555	14.372	16.063	17.906	19.504	21.417	23.239	24.824	26.640	28.743
1.90	1.532	3.068	4.589	6.136	7.638	9.179	10.708	12.272	13.826	15.384	16.804	18.513	19.859	21.417	22.755	24.272
2.00	1.334	2.664	4.001	5.328	6.660	7.973	9.335	10.708	12.003	13.320	14.760	16.063	17.337	18.513	19.859	21.417
2.10	1.173	2.344	3.523	4.688	5.872	7.047	8.212	9.416	10.604	11.745	12.850	14.003	15.170	16.302	17.617	18.832
2.20	1.041	2.084	3.121	4.169	5.201	6.241	7.282	8.338	9.335	10.402	11.497	12.555	13.485	14.563	15.604	16.549
2.30	0.933	1.864	2.801	3.728	4.668	5.601	6.540	7.481	8.402	9.335	10.304	11.145	12.136	13.003	14.003	14.962
2.40	0.840	1.680	2.523	3.361	4.201	5.033	5.872	6.742	7.585	8.402	9.256	10.113	10.923	11.745	12.555	13.485
2.50	0.762	1.523	2.285	3.051	3.806	4.570	5.328	6.102	6.869	7.638	8.402	9.179	9.930	10.708	11.378	12.136
2.60	0.694	1.390	2.084	2.779	3.467	4.169	4.854	5.544	6.241	6.957	7.638	8.338	9.027	9.752	10.402	11.145
2.70	0.636	1.272	1.906	2.546	3.175	3.819	4.458	5.080	5.719	6.350	7.002	7.638	8.275	8.880	9.498	10.208
2.80	0.585	1.169	1.753	2.339	2.920	3.512	4.091	4.688	5.251	5.841	6.425	7.002	7.585	8.212	8.738	9.335
2.90	0.540	1.079	1.621	2.159	2.697	3.241	3.779	4.317	4.854	5.407	5.936	6.463	7.002	7.533	8.091	8.669
3.00	0.500	1.000	1.500	2.000	2.499	3.001	3.501	4.001	4.495	5.010	5.489	6.001	6.501	7.002	7.481	7.973
3.10	0.465	0.929	1.393	1.858	2.324	2.786	3.251	3.715	4.185	4.648	5.104	5.573	6.035	6.501	6.957	7.430
3.20	0.433	0.865	1.299	1.731	2.163	2.594	3.034	3.467	3.901	4.334	4.770	5.201	5.630	6.068	6.501	6.913
3.30	0.404	0.809	1.214	1.618	2.023	2.427	2.830	3.232	3.641	4.045	4.440	4.854	5.251	5.659	6.068	6.463
3.40	0.379	0.757	1.137	1.515	1.893	2.271	2.651	3.034	3.413	3.793	4.169	4.551	4.920	5.302	5.689	6.068
3.50	0.356	0.711	1.067	1.422	1.779	2.133	2.488	2.844	3.203	3.558	3.915	4.267	4.628	4.987	5.328	5.689
3.60	0.334	0.669	1.003	1.339	1.673	2.008	2.339	2.677	3.009	3.340	3.678	4.016	4.352	4.688	5.010	5.354
3.70	0.315	0.630	0.946	1.261	1.576	1.890	2.207	2.523	2.837	3.148	3.467	3.779	4.091	4.404	4.728	5.033
3.80	0.298	0.595	0.893	1.191	1.488	1.785	2.084	2.380	2.677	2.976	3.270	3.569	3.873	4.169	4.458	4.770
3.90	0.282	0.563	0.845	1.126	1.408	1.688	1.972	2.252	2.534	2.815	3.094	3.382	3.665	3.943	4.217	4.495
4.00	0.267	0.533	0.800	1.067	1.334	1.599	1.867	2.133	2.401	2.664	2.936	3.203	3.467	3.728	4.001	4.267
4.10	0.253	0.506	0.759	1.012	1.266	1.517	1.770	2.023	2.276	2.528	2.786	3.034	3.290	3.546	3.793	4.045
4.20	0.240	0.481	0.721	0.961	1.202	1.443	1.683	1.923	2.163	2.406	2.645	2.882	3.121	3.361	3.605	3.846
4.30	0.229	0.457	0.686	0.915	1.144	1.372	1.602	1.830	2.057	2.285	2.517	2.744	2.976	3.203	3.435	3.665
4.40	0.218	0.436	0.654	0.872	1.089	1.307	1.525	1.742	1.961	2.180	2.395	2.613	2.830	3.051	3.270	3.490
4.50	0.208	0.416	0.623	0.831	1.039	1.247	1.454	1.662	1.870	2.077	2.285	2.494	2.704	2.913	3.121	3.320
4.60	0.198	0.397	0.595	0.794	0.992	1.191	1.390	1.588	1.785	1.986	2.185	2.380	2.582	2.779	2.976	3.175
4.70	0.190	0.379	0.569	0.759	0.948	1.138	1.327	1.517	1.707	1.896	2.084	2.276	2.466	2.658	2.844	3.034
4.80	0.181	0.363	0.544	0.726	0.907	1.089	1.270	1.452	1.633	1.814	1.997	2.176	2.359	2.540	2.724	2.905
4.90	0.174	0.348	0.522	0.695	0.869	1.043	1.216	1.391	1.565	1.739	1.913	2.084	2.261	2.433	2.607	2.779
5.00	0.167	0.333	0.500	0.667	0.833	1.000	1.167	1.334	1.500	1.668	1.833	2.000	2.167	2.334	2.499	2.664
5.10	0.160	0.320	0.480	0.640	0.800	0.960	1.119	1.279	1.439	1.599	1.759	1.920	2.080	2.238	2.401	2.558
5.20	0.154	0.307	0.461	0.614	0.768	0.922	1.075	1.229	1.383	1.536	1.691	1.842	1.997	2.150	2.304	2.460
5.30	0.148	0.295	0.443	0.591	0.739	0.886	1.033	1.181	1.329	1.476	1.625	1.773	1.920	2.069	2.216	2.364
5.40	0.142	0.284	0.426	0.568	0.710	0.852	0.995	1.137	1.279	1.420	1.563	1.704	1.848	1.990	2.129	2.271
5.50	0.137	0.273	0.410	0.547	0.684	0.821	0.957	1.094	1.231	1.367	1.504	1.640	1.779	1.913	2.053	2.189
5.60	0.132	0.264	0.395	0.527	0.659	0.790	0.923	1.054	1.186	1.318	1.449	1.581	1.712	1.845	1.975	2.109
5.70	0.127	0.254	0.381	0.508	0.635	0.762	0.889	1.016	1.144	1.270	1.397	1.523	1.652	1.779	1.906	2.034
5.80	0.123	0.245	0.368	0.490	0.613	0.736	0.858	0.980	1.103	1.226	1.348	1.470	1.592	1.715	1.839	1.961
5.90	0.118	0.237	0.355	0.473	0.592	0.710	0.828	0.946	1.065	1.183	1.302	1.420	1.538	1.657	1.776	1.893
6.00	0.114	0.229	0.343	0.457	0.572	0.686	0.800	0.914	1.028	1.143	1.257	1.372	1.486	1.599	1.715	1.830
6.50	0.097	0.194	0.291	0.388	0.485	0.582	0.679	0.776	0.872	0.970	1.067	1.163	1.261	1.357	1.454	1.551
7.00	0.083	0.167	0.250	0.333	0.417	0.500	0.583	0.667	0.750	0.833	0.916	1.000	1.084	1.167	1.250	1.334
7.50	0.072	0.145	0.217	0.290	0.362	0.434	0.507	0.579	0.652	0.724	0.796	0.869	0.941	1.013	1.086	1.158
8.00	0.063	0.127	0.190	0.254	0.317	0.381	0.444	0.508	0.572	0.635	0.698	0.762	0.826	0.889	0.952	1.016
8.50	0.056	0.112	0.168	0.225	0.281	0.337	0.393	0.449	0.505	0.561	0.617	0.674	0.730	0.786	0.842	0.898
9.00	0.050	0.100	0.150	0.200	0.250	0.300	0.350	0.400	0.450	0.500	0.550	0.600	0.650	0.700	0.750	0.800
9.50	0.045	0.090	0.134	0.179	0.224	0.269	0.314	0.359	0.403	0.448	0.493	0.538	0.583	0.627	0.672	0.717
10.00	0.040	0.081	0.121	0.162	0.202	0.242	0.283	0.323	0.364	0.404	0.444	0.485	0.525	0.566	0.606	0.646
10.50	0.037	0.073	0.110	0.146	0.183	0.220	0.256	0.293	0.329	0.366	0.403	0.439	0.476	0.513	0.549	0.586
11.00	0.033	0.067	0.100	0.133	0.167	0.200	0.233	0.267	0.300	0.333	0.367	0.400	0.433	0.467	0.500	0.533
11.50	0.030	0.061	0.091	0.122	0.152	0.183	0.213	0.244	0.274	0.305	0.335	0.366	0.396	0.427	0.457	0.488
12.00	0.028	0.056	0.084	0.112	0.140	0.168	0.196	0.224	0.252	0.280	0.308	0.336	0.364	0.392	0.420	0.448
12.50	0.026	0.052	0.077	0.103	0.129	0.155	0.180	0.206	0.232	0.258	0.283	0.309	0.335	0.361	0.387	0.412
13.00	0.024	0.048	0.071	0.095	0.119	0.143	0.167	0.190	0.214	0.238	0.262	0.286	0.310	0.333	0.357	0.381

Curve: IEC C

Curve #: x P/U	1	2	3	4	5	6	7	8	9	10	11	12	13	14	15	16
	Time to Trip (seconds)															
13.50	0.022	0.044	0.066	0.088	0.110	0.132	0.154	0.177	0.199	0.221	0.243	0.265	0.287	0.309	0.331	0.353
14.00	0.021	0.041	0.062	0.082	0.103	0.123	0.144	0.164	0.185	0.205	0.226	0.246	0.267	0.287	0.308	0.328
14.50	0.019	0.038	0.057	0.076	0.096	0.115	0.134	0.153	0.172	0.191	0.210	0.229	0.249	0.268	0.287	0.306
15.00	0.018	0.036	0.054	0.071	0.089	0.107	0.125	0.143	0.161	0.179	0.196	0.214	0.232	0.250	0.268	0.286
15.50	0.017	0.033	0.050	0.067	0.084	0.100	0.117	0.134	0.150	0.167	0.184	0.201	0.217	0.234	0.251	0.268
16.00	0.016	0.031	0.047	0.063	0.078	0.094	0.110	0.125	0.141	0.157	0.173	0.188	0.204	0.220	0.235	0.251
16.50	0.015	0.029	0.044	0.059	0.074	0.088	0.103	0.118	0.133	0.147	0.162	0.177	0.192	0.206	0.221	0.236
17.00	0.014	0.028	0.042	0.056	0.069	0.083	0.097	0.111	0.125	0.139	0.153	0.167	0.181	0.194	0.208	0.222
17.50	0.013	0.026	0.039	0.052	0.066	0.079	0.092	0.105	0.118	0.131	0.144	0.157	0.170	0.183	0.197	0.210
18.00	0.012	0.025	0.037	0.050	0.062	0.074	0.087	0.099	0.111	0.124	0.136	0.149	0.161	0.173	0.186	0.198
18.50	0.012	0.023	0.035	0.047	0.059	0.070	0.082	0.094	0.105	0.117	0.129	0.141	0.152	0.164	0.176	0.188
19.00	0.011	0.022	0.033	0.044	0.056	0.067	0.078	0.089	0.100	0.111	0.122	0.133	0.144	0.156	0.167	0.178
19.50	0.011	0.021	0.032	0.042	0.053	0.063	0.074	0.084	0.095	0.105	0.116	0.127	0.137	0.148	0.158	0.169
20.00	0.010	0.020	0.030	0.040	0.050	0.060	0.070	0.080	0.090	0.100	0.110	0.120	0.130	0.140	0.150	0.160

www.ElectricalPartManufacturing.com

CURVE INFORMATION AND TABLES



Curve: IEC C

Curve #:	17	18	19	20	21	22	23	24	25	26	27	28	29	30	31	32
x P/U	Time to Trip (seconds)															
1.03	1092.250	1092.250	1092.250	1092.250	1092.250	1092.250	1092.250	1092.250	1092.250	1092.250	1092.250	1092.250	1092.250	1092.250	1092.250	1092.250
1.10	364.083	364.083	364.083	364.083	364.083	364.083	546.125	546.125	546.125	546.125	546.125	546.125	546.125	546.125	546.125	546.125
1.20	156.036	156.036	182.042	182.042	182.042	218.450	218.450	218.450	218.450	218.450	273.063	273.063	273.063	273.063	273.063	273.063
1.30	99.295	109.225	109.225	121.361	121.361	121.361	136.531	136.531	136.531	156.036	156.036	156.036	182.042	182.042	182.042	182.042
1.40	72.817	72.817	78.018	84.019	91.021	91.021	99.295	99.295	109.225	109.225	109.225	121.361	121.361	121.361	136.531	136.531
1.50	54.613	57.487	60.681	64.250	68.266	68.266	72.817	78.018	78.018	84.019	84.019	91.021	91.021	99.295	99.295	99.295
1.60	43.690	45.510	49.648	52.012	54.613	57.487	57.487	60.681	64.250	68.266	68.266	72.817	72.817	78.018	78.018	84.019
1.70	36.408	37.664	40.454	42.010	43.690	47.489	49.648	49.648	52.012	54.613	57.487	60.681	60.681	64.250	64.250	68.266
1.80	30.340	32.125	34.133	35.234	37.664	39.009	40.454	43.690	45.510	45.510	47.489	49.648	52.012	54.613	54.613	57.487
1.90	26.006	27.306	28.743	30.340	32.125	34.133	35.234	36.408	37.664	40.454	42.010	43.690	43.690	45.510	47.489	49.648
2.00	22.755	23.745	25.401	26.640	28.006	29.520	30.340	32.125	33.098	34.133	36.408	37.664	39.009	40.454	42.010	42.010
2.10	19.859	21.005	22.291	23.239	24.824	26.006	27.306	28.006	29.520	30.340	32.125	33.098	34.133	35.234	36.408	37.664
2.20	17.617	18.832	19.859	21.005	21.845	22.755	23.745	24.824	26.006	27.306	28.006	29.520	30.340	31.207	32.125	33.098
2.30	15.830	16.804	17.617	18.513	19.504	20.608	21.417	22.291	23.239	24.272	25.401	26.006	27.306	28.006	28.743	29.520
2.40	14.372	15.170	16.063	16.804	17.617	18.513	19.162	20.227	21.005	21.845	22.755	23.745	24.272	25.401	26.006	26.640
2.50	13.003	13.653	14.563	15.170	16.063	16.804	17.617	18.204	19.162	19.859	20.608	21.417	22.291	22.755	23.745	24.272
2.60	11.745	12.555	13.160	13.826	14.563	15.384	16.063	16.549	17.337	18.204	18.832	19.504	20.227	21.005	21.417	22.291
2.70	10.814	11.497	12.136	12.701	13.320	14.003	14.563	15.170	15.830	16.549	17.066	17.906	18.513	19.162	19.859	20.227
2.80	9.930	10.502	11.145	11.745	12.272	12.850	13.485	14.003	14.563	15.170	15.830	16.302	17.066	17.617	18.204	18.832
2.90	9.179	9.752	10.304	10.814	11.378	11.872	12.412	13.003	13.485	14.003	14.563	15.170	15.604	16.302	16.804	17.337
3.00	8.467	9.027	9.498	10.021	10.502	11.033	11.497	12.003	12.555	13.003	13.485	14.003	14.563	14.962	15.604	16.063
3.10	7.915	8.338	8.808	9.256	9.752	10.208	10.708	11.145	11.620	12.136	12.555	13.003	13.485	14.003	14.372	14.962
3.20	7.380	7.802	8.212	8.669	9.102	9.498	9.930	10.402	10.814	11.260	11.745	12.136	12.555	13.003	13.485	13.826
3.30	6.869	7.282	7.692	8.091	8.467	8.880	9.335	9.666	10.113	10.502	10.923	11.378	11.745	12.136	12.555	13.003
3.40	6.425	6.827	7.186	7.585	7.973	8.338	8.738	9.102	9.498	9.840	10.208	10.604	11.033	11.378	11.745	12.136
3.50	6.035	6.387	6.742	7.093	7.481	7.802	8.151	8.533	8.880	9.256	9.581	9.930	10.304	10.708	11.033	11.378
3.60	5.689	6.035	6.350	6.701	7.002	7.380	7.692	8.031	8.338	8.669	9.027	9.335	9.666	10.021	10.402	10.708
3.70	5.354	5.659	6.001	6.314	6.620	6.913	7.233	7.585	7.858	8.212	8.533	8.808	9.179	9.416	9.752	10.113
3.80	5.057	5.354	5.659	5.969	6.241	6.540	6.827	7.139	7.430	7.746	8.031	8.338	8.600	8.953	9.256	9.498
3.90	4.791	5.057	5.354	5.630	5.904	6.206	6.463	6.742	7.047	7.331	7.585	7.858	8.151	8.467	8.738	9.027
4.00	4.532	4.791	5.057	5.328	5.601	5.872	6.136	6.387	6.660	6.913	7.186	7.481	7.746	7.973	8.275	8.533
4.10	4.300	4.551	4.812	5.057	5.302	5.573	5.810	6.068	6.314	6.580	6.827	7.093	7.331	7.585	7.858	8.091
4.20	4.091	4.334	4.570	4.812	5.057	5.277	5.516	5.779	6.001	6.241	6.501	6.742	6.957	7.233	7.430	7.692
4.30	3.887	4.122	4.352	4.570	4.812	5.033	5.251	5.489	5.719	5.936	6.171	6.387	6.620	6.869	7.093	7.331
4.40	3.703	3.915	4.137	4.352	4.570	4.791	5.010	5.226	5.434	5.659	5.872	6.102	6.314	6.540	6.742	6.957
4.50	3.535	3.741	3.943	4.153	4.369	4.570	4.770	4.987	5.201	5.407	5.601	5.810	6.035	6.241	6.425	6.660
4.60	3.371	3.569	3.766	3.972	4.169	4.369	4.570	4.770	4.965	5.152	5.354	5.544	5.749	5.969	6.136	6.350
4.70	3.222	3.413	3.605	3.793	3.986	4.169	4.369	4.551	4.749	4.942	5.128	5.302	5.489	5.689	5.872	6.068
4.80	3.085	3.270	3.446	3.629	3.806	3.986	4.169	4.352	4.532	4.728	4.898	5.080	5.251	5.434	5.630	5.810
4.90	2.952	3.130	3.300	3.479	3.653	3.819	4.001	4.169	4.352	4.513	4.688	4.876	5.033	5.226	5.381	5.573
5.00	2.830	3.001	3.166	3.330	3.501	3.665	3.832	4.001	4.169	4.334	4.495	4.668	4.833	5.010	5.177	5.328
5.10	2.717	2.882	3.042	3.203	3.361	3.523	3.678	3.832	4.001	4.153	4.317	4.476	4.648	4.791	4.965	5.128
5.20	2.613	2.765	2.920	3.068	3.222	3.382	3.535	3.690	3.846	4.001	4.153	4.300	4.458	4.609	4.770	4.920
5.30	2.511	2.658	2.808	2.952	3.103	3.251	3.392	3.546	3.690	3.832	3.986	4.137	4.283	4.422	4.570	4.728
5.40	2.416	2.558	2.697	2.844	2.984	3.121	3.270	3.413	3.546	3.690	3.832	3.972	4.122	4.267	4.404	4.551
5.50	2.324	2.460	2.601	2.737	2.874	3.009	3.148	3.280	3.424	3.558	3.690	3.832	3.972	4.106	4.234	4.369
5.60	2.238	2.369	2.505	2.632	2.765	2.897	3.034	3.166	3.290	3.424	3.558	3.690	3.819	3.957	4.091	4.217
5.70	2.159	2.285	2.411	2.540	2.671	2.793	2.920	3.051	3.175	3.300	3.435	3.558	3.678	3.806	3.943	4.060
5.80	2.084	2.207	2.329	2.449	2.576	2.697	2.815	2.944	3.060	3.184	3.310	3.435	3.558	3.678	3.793	3.915
5.90	2.012	2.129	2.247	2.364	2.482	2.601	2.724	2.837	2.960	3.077	3.194	3.310	3.435	3.546	3.665	3.779
6.00	1.944	2.057	2.171	2.285	2.401	2.517	2.626	2.744	2.859	2.968	3.085	3.203	3.310	3.424	3.546	3.653
6.50	1.647	1.745	1.842	1.940	2.038	2.133	2.229	2.329	2.422	2.523	2.619	2.717	2.815	2.913	3.009	3.103
7.00	1.417	1.500	1.583	1.668	1.750	1.833	1.916	2.000	2.084	2.167	2.252	2.334	2.416	2.499	2.582	2.664
7.50	1.231	1.303	1.376	1.449	1.521	1.592	1.665	1.736	1.811	1.883	1.954	2.026	2.100	2.171	2.243	2.319
8.00	1.079	1.143	1.207	1.270	1.334	1.397	1.460	1.523	1.588	1.650	1.715	1.779	1.842	1.906	1.968	2.030
8.50	0.955	1.010	1.067	1.123	1.180	1.236	1.291	1.347	1.404	1.460	1.515	1.572	1.628	1.683	1.739	1.796
9.00	0.850	0.900	0.950	1.000	1.050	1.100	1.150	1.200	1.250	1.300	1.350	1.400	1.451	1.500	1.549	1.599
9.50	0.762	0.807	0.851	0.896	0.941	0.986	1.030	1.076	1.120	1.166	1.210	1.255	1.300	1.345	1.390	1.433
10.00	0.687	0.727	0.768	0.808	0.849	0.889	0.930	0.970	1.010	1.050	1.091	1.132	1.172	1.212	1.253	1.293
10.50	0.622	0.659	0.696	0.732	0.769	0.805	0.842	0.879	0.916	0.952	0.988	1.026	1.061	1.099	1.135	1.172
11.00	0.567	0.600	0.633	0.667	0.700	0.734	0.766	0.800	0.833	0.867	0.900	0.934	0.967	1.000	1.033	1.067
11.50	0.518	0.549	0.579	0.610	0.640	0.671	0.701	0.732	0.762	0.793	0.823	0.853	0.884	0.914	0.945	0.975
12.00	0.476	0.504	0.532	0.560	0.588	0.615	0.643	0.671	0.699	0.727	0.755	0.783	0.811	0.839	0.867	0.895
12.50	0.438	0.464	0.490	0.515	0.541	0.567	0.593	0.618	0.644	0.670	0.696	0.721	0.747	0.773	0.798	0.824
13.00	0.405	0.429	0.452	0.476	0.500	0.524	0.547	0.572	0.595	0.619	0.643	0.667	0.690	0.714	0.738	0.762

Curve: IEC C

Curve #:	17	18	19	20	21	22	23	24	25	26	27	28	29	30	31	32
x P/U	Time to Trip (seconds)															
13.50	0.375	0.397	0.419	0.441	0.463	0.485	0.508	0.530	0.552	0.574	0.596	0.618	0.640	0.662	0.684	0.706
14.00	0.349	0.369	0.390	0.410	0.431	0.451	0.472	0.492	0.513	0.533	0.554	0.574	0.595	0.615	0.636	0.656
14.50	0.325	0.344	0.363	0.382	0.401	0.421	0.440	0.459	0.478	0.497	0.516	0.535	0.554	0.573	0.593	0.612
15.00	0.304	0.321	0.339	0.357	0.375	0.393	0.411	0.429	0.446	0.464	0.482	0.500	0.518	0.536	0.554	0.572
15.50	0.284	0.301	0.318	0.334	0.351	0.368	0.385	0.401	0.418	0.435	0.451	0.468	0.485	0.501	0.518	0.535
16.00	0.267	0.282	0.298	0.314	0.329	0.345	0.361	0.377	0.392	0.408	0.424	0.439	0.455	0.471	0.486	0.502
16.50	0.251	0.265	0.280	0.295	0.310	0.324	0.339	0.354	0.369	0.383	0.398	0.413	0.428	0.442	0.457	0.472
17.00	0.236	0.250	0.264	0.278	0.292	0.306	0.319	0.333	0.347	0.361	0.375	0.389	0.403	0.417	0.431	0.444
17.50	0.223	0.236	0.249	0.262	0.275	0.288	0.301	0.314	0.328	0.341	0.354	0.367	0.380	0.393	0.406	0.419
18.00	0.211	0.223	0.235	0.248	0.260	0.272	0.285	0.297	0.310	0.322	0.334	0.347	0.359	0.372	0.384	0.396
18.50	0.199	0.211	0.223	0.234	0.246	0.258	0.270	0.281	0.293	0.305	0.317	0.328	0.340	0.352	0.363	0.375
19.00	0.189	0.200	0.211	0.222	0.233	0.244	0.256	0.267	0.278	0.289	0.300	0.311	0.322	0.333	0.344	0.356
19.50	0.179	0.190	0.200	0.211	0.222	0.232	0.243	0.253	0.264	0.274	0.285	0.295	0.306	0.316	0.327	0.338
20.00	0.170	0.180	0.190	0.200	0.211	0.221	0.231	0.241	0.251	0.261	0.271	0.281	0.291	0.301	0.311	0.321

www.ElectricalPartManufacturing.com

Primary Injection Testing

Complete system operation can be checked by injecting current through the phase and ground CT's, and by providing a potential source. To do this a primary (high current) test set is required. The operation of the entire system including CT's can then be checked. If this equipment is not available, secondary injection tests can be done to check everything except the CT's. This procedure is described in the following sections.

Secondary Injection Testing

Single phase secondary injection testing can be performed using the test setup in Figure 8.1. The tests described here apply to the relay with factory setpoints unchanged. Similar tests can be performed when new setpoints have been stored. Make a note of any setpoints changed so that these can be returned to their original values. To avoid unnecessary breaker tripping and alarms it is recommended that related connections be removed during these tests.

If a trip has been assigned to another relay instead of the trip relay, then the latching relay in Figure 8.1, should be connected to this relay's contacts for the tests. Refer to sections 5 & 6 of this manual to locate the messages referred to in these test procedures. Note that these tests cannot be performed unless the correct access code is entered in page 1 of setpoints and the access jumper or keyswitch is closed. When values are stored, by pressing the STORE key, verify that the NEW SETPOINT STORED message appears.

Phase Current Input Function Check

The 565/575 Relay must read the phase current signals from the CT's correctly to provide the instantaneous and timed overcurrent protection. To determine if the 565/575 Relay is reading the correct current values with the test setup in Figure 8.1, apply control power, change the phase overcurrent pickup level to 100% of the CT primary in page 2 of setpoints, and put the 565/575 Relay into actual values mode. Use the test set current adjustment to set the phase current injected into the phases, to a mid value, which is read from the ammeter. This can be 2 Amps if a 5 Amp CT is being used or 0.4 Amps if a 1 Amp CT is being used.

Read the displayed value of current for the selected phase from actual values Page 1, message A 1.2, 1.3, or 1.4. With the factory setpoints the CT ratio will be set at 100/5. Verify that the displayed current is:

Displayed current = Injected current × CT Primary Rating ÷ CT Secondary Rating

For example, if 5 Amp CT's are being used, and the ammeter reading has been adjusted to 2 Amps, the display should read:

Displayed current = $2 \times 100/5$ or 40 Amps.

If a CT ratio other than this is used, it should be entered in the above equation. Turn the phase current off.

Phase Instantaneous Pickup and Trip Check

Test phase A instantaneous overcurrent pickup as follows:

Press the SETPOINTS key to enter setpoints mode and the PAGE key to view page 2. Using the LINE DOWN key read the phase CT primary rating from message S 2.2 and verify that the phase instantaneous trips are enabled by viewing message S 2.11. If not, select enabled using the NEXT CHOICE key and store the value. Use the LINE UP key to view message S 2.3 and set the Phase overcurrent pickup level to 25%. View message S 2.12 and enter a value for the phase instantaneous overcurrent trip level, as a multiple of the overcurrent pickup level, for example, 3.

Set the phase instantaneous trip time delay to instantaneous as follows:

Use the LINE DOWN key to view message S 2.13, phase instantaneous trip delay. Enter 0 for this setpoint. Press STORE to store the setpoint in the 565/575 Memory. Verify that INST is displayed by message S 2.13.

Using the test setup variac, slowly increase the phase current injected until the trip or other assigned relay is activated and the corresponding LED is illuminated. Verify that the injected current at the time of trip corresponds to the instantaneous pickup value entered in the setpoints message S 2.12, $\pm 5\%$. In this case, the pickup level was set at 25% of the CT secondary rating, (5 Amps) or 1.25 Amps. The trip level is three times this or 3.75 Amps.

Check that the actual values page 5 message gives Phase A instantaneous overcurrent, as the cause of last trip. Slowly decrease the phase current and check that the trip relay can be reset at or below 95% of the pickup level.

Phase Overcurrent Curve Verification

With factory settings view setpoints message S 2.4. This gives the curve shape currently in use for the overcurrent protection. Note which curve has been selected.

View message S 2.3, which gives the phase overcurrent pickup level. Use the LINE DOWN key to view message S 2.5, which is the phase overcurrent curve number. Enter and store a value of 1 for this. Using the test setup current adjustment, set the phase current to the trip level and turn off. In this example, this was three times the pickup, or 3.75 Amps as described above. Without changing the current setting, press the test set start button, to activate the timer. Check the time elapsed when the trip or other assigned relay

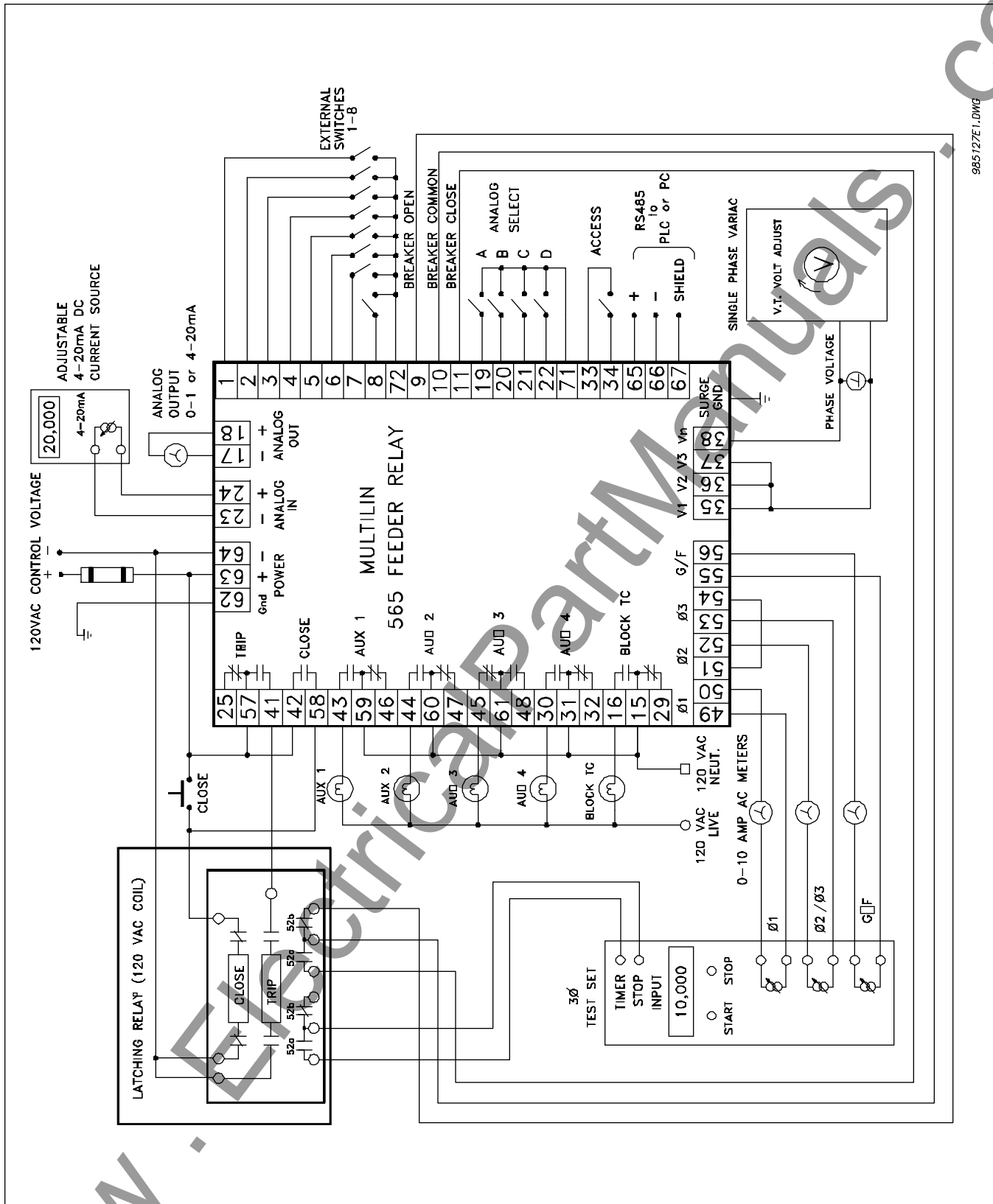

985127E1.DWG

Figure 8.1 Secondary Injection Test Setup

LED is illuminated. Select the curve in use from Appendix D and read the time to trip for the chosen current. Verify that the measured time corresponds to the time indicated for this current by the curve, within the accuracy given in the specifications, Section 9 of this manual. This test can be repeated for other currents, as a further check.

Ground Current Input Function Check

This test determines if the 565/575 Relay is reading the correct ground current values. Using the test set of Figure 8.1, apply control power and put the relay into the setpoints mode. Use the LINE DOWN key to view message S 3.5 and adjust the ground overcurrent pickup level to 40% of the CT rating.

Check the setpoints message S 3.2 to verify that the ground sensing is enabled. If not, select and store ENABLED for this setpoint. Press the LINE DOWN key and read the sensing system selected from message S 3.3. If zero sequence sensing has been selected, view message S 3.4 to determine the primary CT rating. If residual sensing has been selected in message S 3.3, determine the phase current CT rating, as described in the phase current input function check. Using a CT ratio of 100/5 as an example, the displayed current can be calculated as follows:

Displayed current = Injected current × CT Primary Rating ÷ CT Secondary Rating.

Use the test set current adjustment to set the injected ground current, read from the ammeter, to a convenient value, for example, 1.5 Amps, if a 5 Amp CT is being used. The display should read:

Displayed current = $1.5 \times 100/5$ or 30 Amps.

If a CT ratio other than this is used, it should be entered in the above equation.

Read the displayed value of ground current from actual values Page 1, message A 1.5 and verify that it agrees with the calculated value.

Ground Instantaneous Pickup and Trip Check

Ground overcurrent conditions may be detected by either residual current sensing or zero sequence sensing. The test setup shown in Figure 8.1 may be used in either case. Ground protection is tested by injecting a current at terminals 55 and 56 of the 565/575 Relay to simulate ground overcurrent conditions.

First view message S 3.2 to verify that ground sensing is enabled. If not, enable it. Use the LINE DOWN key to view the CT rating for zero sequence current, or refer to phase CT ratio for residual currents. Make a note of this value.

Use the LINE DOWN key to view setpoints message S 3.5 and verify that the ground overcurrent pickup is set at 12%. If not, enter and store this value. View message S 3.13 and check that the ground instantaneous trips are enabled. If not, select and store ENABLED in this message. View message S 3.14, and enter the chosen value for the ground instantaneous trip level, as a multiple of the overcurrent pickup level, for example, 3.

View message S 3.15, ground instantaneous delay. Select 0 for this value to set the delay off. Press the STORE key to store the setpoint and verify that the message displays INST. Read message S 3.16 to check which relay the ground trip has been assigned. The factory setpoint will be the trip relay.

In this example, the pickup level is 12% of 5 Amps (the CT ratio or CT rating depending on which sensing system is chosen) or 0.6 Amps. The trip level was chosen to be 3 times this pickup level or 1.8 Amps. Using the test setup current adjustment, slowly increase the current injected until the ammeter reads 1.8 Amps. Verify that the trip relay, or whichever relay to which the signal was assigned, is activated and the corresponding LED is illuminated.

Check that the actual values section gives ground instantaneous overcurrent as the cause of last trip. Using the test set current adjustment, decrease the injected current slowly and check that the trip or other assigned relay can be reset at 95% of the pickup setting.

Ground Curve Verification

With the above settings unchanged, view message S 3.6, which gives the ground protection curve in use. Record which curve has been selected. Use LINE DOWN to view setpoints message S 3.7 which is the ground overcurrent curve number. Enter and store a value of 1 for this.

Enter the actual values mode, and use LINE DOWN to view message A 1.5 which displays ground current. Using the test setup, slowly increase the injected current until the ammeter indicates a convenient value higher than the pickup value. Two times the pickup level is chosen here so if the CT rating is 5 Amps and 12% is chosen as the pickup level, then the injected current should be set at two times 12% of 5 (0.6) or 1.2 Amps.

Without changing the current setting, press the start button on the test set. This will activate the timer until the trip or other assigned relay is activated. When the assigned ground relay is activated and the corresponding LED illuminates, check the time indicated on the test set timer. Refer to the ground curve in use in Appendix D of this manual. Verify that the measured time corresponds to the curve time, within the accuracy stated in the specifications in Section 9 of this manual.

Repeat the test for other values of ground current and verify that the trip time corresponds to the time on the curve as

before. This verifies the accuracy of the curve in use.

When the tests are complete, reprogram the ground instantaneous trip delay, overcurrent pickup, and curve number setpoints to their original values.

Voltage Input Function Check

Enter the setpoints mode and read the VT nominal secondary voltage from message S 9.3. Adjust the single phase variac in the test setup until the phase voltage meter reads the nominal voltage. Put the 565/575 Relay in Actual values mode, and read the phase voltage from messages A 6.2 to 6.4 or A 6.5 to 6.7, depending on the sensing system. Verify that these correspond to the feeder primary volts entered in S 9.4.

Undervoltage Trip and Alarm Check

View message S 9.5 to determine if the undervoltage trip is enabled. If not, select and store ENABLED in this message. Read the undervoltage trip level from message S 9.6 and set this at a convenient value, say 90%. Set the undervoltage time delay to 1 second in message S 9.7. Check the relay to which the undervoltage trip has been assigned in message S 9.8. For the purposes of this test, the trip and Aux 1 relays are used.

Slowly lower the phase voltage injected by the test set variac to 90% of the nominal level and verify that the assigned relays are activated. For example, if the nominal secondary voltage is 240 Volts, and the trip level was selected as 90%, the selected relays should be activated when the voltage is dropped below 90% of 240 or 216 Volts. Note that the breaker must be closed.

The undervoltage alarm function operation can now be checked by following a similar procedure, with reference to messages S 9.9 to 9.12 instead of S 9.5 to 9.8.

Overvoltage Trip and Alarm Check

View message S 9.13 to determine if the overvoltage trip is enabled. If not, select and store ENABLED in this message. Read the overvoltage trip level from message S 9.14 and set this at a convenient value, say 115%. Set the overvoltage time delay to 1 second in message S 9.15. Check the relay to which the overvoltage trip has been assigned in message S 9.16, for the purposes of this test, the trip relay is used.

Slowly increase the phase voltage injected by the test set variac to 115% of the nominal level and verify that the trip or other assigned relay is activated. For example, if the nominal voltage is 240 Volts, and the trip level was selected as 115%, the selected trip relay should be activated when the voltage is increased above 115% of 240 or 276 Volts. Note that the

breaker must be closed.

The overvoltage alarm function operation can now be checked by following a similar procedure with reference to messages S 9.17 to 9.20 instead of S 9.13 to 9.16.

Output Relay Functional Check

The operation of the output relays can be checked by entering the setpoints mode page 8 and energizing each in turn using messages S 8.2 to S 8.4. Energizing each relay should cause the corresponding light on the test setup to illuminate, when the relay normally open contacts close. Note that the Aux 3 relay is failsafe and that its corresponding LED will go out. The corresponding front panel LED will also indicate the status of the relay. The normally closed contacts of each relay may also be checked, by first disconnecting the AC voltage which is present at the contacts. Now connect an ohmmeter across the contact and energize the corresponding relay, as above. For example, terminals 59 and 46 are used for Auxiliary relay 1 normally closed contact. Verify that the contact is first closed (conducting) and then indicates an open state when the relay is energized. Once again, note that Aux 3 is failsafe and that its normally open contacts can be tested in a similar manner. At first the contacts should be open and then after energizing they should be closed (conducting).

Analog Input Function Check

The analog input may be checked by injecting known analog signals and verifying that the correct values are displayed. First check that the analog input feature is enabled, in message S 5.2 of setpoints. If not, select enabled, using the NEXT CHOICE key. Read and make a note of the minimum and maximum scale factors in use from messages S 5.7 and 5.8. Set the injected current on the milliamp current source adjustment to 4 milliamps. Read the value of the analog input from message A 2.3. This should be the same as the minimum scale factor read in setpoints. Adjust the injected current on the milliamp current source to 20 milliamps. Read the value of the analog input from message A 2.3 of actual values. This should be the same as the maximum scale factor read in page 5 of setpoints.

Analog Output Function Check

The analog output feature can be checked as follows. First set the analog out parameter in page 6 of Setpoints to external analog select. Next select an output parameter by setting the correct combination of analog select switches. For example, to select phase A current as the output parameter, switches A to D are open. Adjust the test set phase current adjustment to inject a convenient level of phase current. For example, 0.5 Amps might be injected for a relay with a 1 Amp CT secondary or 2.5 Amps for a 5 Amp CT secondary. Read the value of the analog output at terminals

17 and 18 using a suitable meter. Verify that this output is 8mA DC with a phase overcurrent pickup level of 100%

Power Loss Check

This can be done when the above checks have been completed. First, make a note of any setpoint and then with power applied, trip the Relay on any fault. For example this can be done by simply increasing the injected current to simulate a ground overcurrent and waiting for the timed overcurrent curve to come into operation. When the trip relay or other assigned relay is activated and the associated LED illuminated, remove all power and current from the 565/575 Relay. Leave it in this condition for a short time, say one minute.

Restore power and verify that the fault indication remains, ie, the LED on the front panel remains illuminated. Select setpoints mode and view the earlier noted message. Verify that the relay still displays the same value. This verifies that trip annunciations and setpoints are unaffected by loss of power.

Enable all functions which were disabled for these tests. Return the injected current to zero and return all setpoints to their original values. Finally, remove the access jumper or open the keyswitch. Remove all test apparatus and return the system wiring to normal.

www.ElectricalPartManuals.com

Technical Specifications

Phase Overcurrent Protection:

Timed overcurrent pickup:
 Range 25%-250% of CT in steps of 1%.
 Time dial: 32 selections.
 Instantaneous overcurrent pickup:
 Range 1 to 18 times phase pickup, in steps of 0.5.
 Instantaneous trip delay:
 No delay after first cycle of detected overcurrent if "Inst" is selected. Otherwise, 1 to 40 cycles delay after first cycle of detected overcurrent.

Ground Overcurrent Protection:

Timed overcurrent pickup:
 Range 5% to 100% of CT in steps of 1%.
 Time dial: 32 selections.
 Instantaneous overcurrent pickup:
 Range 1 to 7 times ground pickup, in steps of 0.5.
 Instantaneous trip delay:
 No delay after first cycle of detected overcurrent if "Inst" is selected. Otherwise, 1 to 40 cycles delay after first cycle of detected overcurrent.

Phase and Ground Timed Overcurrent Curves:

Normal Inverse.
 Very Inverse.
 Extremely Inverse.
 Moderately Inverse.
 IEC A.
 IEC B.
 IEC C.
 Custom Curve. 79 Breakpoints, user programmable.

Timing Accuracy for Phase and Ground:

Instantaneous: Less than three cycles.
 Timed: current $\geq 1.5 \times$ pickup: $\pm 3\%$ of table value, ± 0.1 seconds, whichever is greater.
 current $< 1.5 \times$ pickup: $\pm 10\%$ of table value.

Measurements:

Response: RMS Responding.
 Display accuracy for load currents:
 $\pm 3\%$ from 25-100% CT primary.
 Bandwidth: 0-120 Hz
 Display update rate:
 Greater than once per 2 seconds.

Phase Current Inputs:

CT secondary: 1 Amp or 5 Amp.
 Saturation: 20 Times CT.
 CT primary: 10-5000 Amp in 5 Amp steps.
 CT burden: Less than 0.2 VA per phase, at 100% of CT.
 CT rating: 15 Amps continuous
 Momentary: $20 \times$ CT input rating for 3 seconds

Ground Current Input:

CT secondary: 1 Amp or 5 Amp.
 Saturation: 20 times the programmed overcurrent pickup level.
 CT primary: 10-5000 Amps in 5 Amp steps.
 CT burden: Less than 0.2 VA per phase at rated CT secondary current.
 CT rating: 15 Amps continuous.
 Momentary: $20 \times$ CT input rating for 3 seconds

Phase and Ground Overcurrent Alarm.

Alarm level: 0.5 to 3.0 times overcurrent pickup in steps of 0.1.
 Time delay: 1 to 255 seconds in steps of one second.

Voltage Inputs:

Inputs (WYE, DELTA, or DELTA/WYE):
 48 to 240
 VT burden: less than 0.2 VA at rated input.
 Display accuracy: $\pm 3\%$ of nominal input.
 Display: RMS values for Va-b, Vb-c, Vc-a, (Va-n, Vb-n, Vc-n line to neutral connection).
 Display update rate:
 Greater than once per 3 seconds.

Overvoltage Alarm and Trip:

Pickup: 101 to 125% in steps of 1%.
 Delay: 0.1 to 25.5 seconds in steps of 0.1 seconds.

Undervoltage Alarm and Trip:

Pickup: 30 to 100% nominal, in steps of 1%.
 Delay: 0.1 to 25.5 seconds in steps of 0.1 seconds.

Frequency Measurement:

Accuracy: ± 0.1 Hz.
 Measured: across Phase A.

Output Contacts:

10 Amp/250 VAC resistive.
 10 Amp/30 volt DC resistive. - 20 Amp Make and Carry
 0.4 Amp/125 Volt DC (L/R = 7mS).
 Maximum voltage 380VAC/125VDC.
 10 Amp continuous, maximum voltage 300 VDC.

SPECIFICATIONS



Analog Output (Isolated):

Accuracy: $\pm 5\%$ of full scale reading.
Range: 0 to 1 mA or 4 to 20 mA, software selectable.
Maximum Volts: maximum 30V (DC or p-pAC) can be present at terminals.

Control Power:

AC voltage: 120 VAC and 240 VAC nominal. Range 90-260 VAC, 60 Hz.
DC voltage: 125 VDC and 250 VDC nominal. Range 95 to 280 VDC.
Maximum supply power:
50 Watts.

or

DC voltage: 48 VDC nominal. Range 20-60 VDC.
Maximum supply power:
25 Watts.

Environment:

	565/575 Relay	Display Only
Operating Temperature Range:	-30°C to +80°C	-20°C to +70°C
Storage Temperature:	-30°C to +80°C	-30°C to +80°C

NOTE: At extremely low temperatures (below -20°C), the 565/575 LCD display exhibits very slow responses to alphanumeric changes. At high temperatures (60°C and above) the LCD display darkens, making it difficult to view displayed messages which indicate the relay's status.

Tests:

Dielectric strength: Hipot tested to:
Drawout case and terminal block: 2500 VAC, 50/60 Hz for 1 min.
Relay and drawout case: 1500 VAC, 50/60 Hz for 1 min.

Interference:

ANSI/IEEE: C37.90.1

Dimensions:

Overall depth behind mounting surface:
12.78"x7.75"x8.75"
Unit Weight: 20 lbs.
Shipping Weight: 24 lbs.

Burn In Temperature:

60°C for 24 hours.

Design and specifications subject to change without notice.

Customer service

For customer service and assistance contact your nearest MULTILIN agent or one of the MULTILIN offices listed below quoting the appropriate part number and the 565/575 Relay serial and revision number.

Before shipping any parts either as part of a warranty claim or which have been damaged in transit, contact the nearest regional office or Multilin office to obtain a Return Authorization number (RA).

GE MULTILIN

A General Electric Company

215 Anderson Avenue,
Markham,
Ontario L6E 1B3,
Canada.

Telephone: (905) 294-6222
Fax: (905) 294-8512

MULTILIN CORP.

9746 Whithorn Dr.
Houston,
Texas 77095,
U.S.A.

Telephone: (713) 855-1000
Fax: (713) 859-1091

www.ElectricalPartManuals.com

www.ElectricalPartManuals.com

Troubleshooting guide.

The 565/575 Relay is fully tested before leaving the factory. Should the relay seem not to function when power is applied, first verify that the service LED on the front panel of the relay is not illuminated. If the service LED is illuminated, contact Multilin product support. If not, check that all wiring connec-

tions have been correctly made and that all tests are performed in the order listed. If all tests fail to isolate the fault, contact Multilin customer support. Note that before doing any tests, the access jumper (or keyswitch if installed) must be installed as described in section 2 of this manual, and the access code must be entered in page 1 of setpoints. The table below lists some of the more common reasons for apparent malfunctions.

MALFUNCTION	ACTION	REFERENCE
1. Display does not light up.	<ol style="list-style-type: none"> 1. Check control power voltage and connections at terminals 62 to 64. 2. Verify that the control voltage is within the limits indicated on the serial number label which is found on the side of the relay chassis. 3. Check control power fuses. 4. Check that the relay is fully inserted into the drawout case. 	<p>Relay wiring diagram</p> <p>Relay wiring diagram</p> <p>Instruction manual installation instructions, section 2.</p>
2. Display lights but power up message does not appear.	<ol style="list-style-type: none"> 1. Verify that the control voltage is within the limits indicated on the serial number label which is found on the side of the relay chassis. 	Relay wiring diagram.
3. No phase current readings displayed.	<ol style="list-style-type: none"> 1. Verify that the current readings are selected for display. Press the ACTUAL VALUES key the LINE DOWN key to view the messages in actual values page 1. 2. Verify that the phase current wiring is correct. 3. Perform the phase current input function check. 	<p>Actual values page 1.</p> <p>Relay wiring diagram.</p> <p>Instruction manual section 8.</p>
4. Incorrect phase current readings displayed.	<ol style="list-style-type: none"> 1. Measure the current flowing into the 565 CT terminals, using a clamp-on ammeter. 2. Check that the correct phase CT primary rating has been entered and stored in setpoints. 	Setpoints page 2.
5. No voltage readings displayed.	<ol style="list-style-type: none"> 1. Verify that the voltage readings are selected for display. Use the LINE DOWN key to view the messages in actual values page 6. 2. Verify that the VT wiring connections have been correctly made. 	<p>Actual values page 6.</p> <p>Relay wiring diagram.</p>
6. Incorrect voltage readings displayed.	<ol style="list-style-type: none"> 1. Check that the correct voltage is appearing at the 565 VT terminals. 2. Check that the correct voltage transformer sensing system, nominal secondary voltage and feeder primary voltage has been entered in setpoints. 	<p>Relay wiring diagram.</p> <p>Setpoints page 9.</p>
7. Under or Overvoltage trip relay not energized by fault condition.	<ol style="list-style-type: none"> 1. Check that the under or overvoltage trip is enabled in setpoints. 	Setpoints page 9.

APPENDIX B



MALFUNCTION	ACTION	REFERENCE
	<ol style="list-style-type: none"> 2. Check that the correct voltage transformer sensing system, secondary voltage and VT feeder primary voltage have been entered in setpoints. Verify that all the voltage sensing wiring is correct. 3. Ensure that the trip relay wiring to the breaker trip circuit is correct at terminals 41 and 57. 4. Verify which relay(s) has been selected to be activated by the under or overvoltage condition, in the voltage setpoints. 5. Check the under or overvoltage trip level setpoint and verify that the voltage is exceeding this level. Determine the under or overvoltage trip delay from the setpoints, and verify that the fault condition is present for longer than this time. 6. Perform calibration mode relay test to verify the operation of the trip relay. 	<p>Setpoints page 9 and relay wiring diagram.</p> <p>Relay wiring diagram.</p> <p>Setpoints page 9.</p> <p>Setpoints page 9.</p> <p>Setpoints page 8.</p>
<p>8. Phase overcurrent protection not energizing trip relay(s).</p>	<ol style="list-style-type: none"> 1. Check phase CT rating, connections and polarity. 2. Verify that the correct protection curve, pickup level and curve number have been entered in setpoints. 3. If the custom curve has been chosen, use the Line Down key to check the time to trip for each breakpoint. 4. Perform calibration mode relay test to verify the operation of the trip relay. 	<p>Setpoints page 2 and instruction manual section 6.</p> <p>Setpoints page 2.</p> <p>Setpoints page 8.</p>
<p>9. Phase overcurrent protection causes trip but no alarm.</p>	<ol style="list-style-type: none"> 1. Check that the phase overcurrent alarm is enabled in setpoints. 2. Verify the relay to which the alarm signal has been assigned. 3. Check that the alarm level setpoint is less than the trip level setpoint and that the fault current is between these two values. 4. Check the phase overcurrent alarm time delay setpoint and ensure that the alarm condition is present for longer than this time. Note that if the overcurrent level rises to the trip level before the timed period, a trip will occur before the alarm. 5. Perform calibration mode relay test to verify operation of the assigned relay(s). 	<p>Setpoints page 2.</p> <p>Setpoints page 2.</p> <p>Setpoints page 2.</p> <p>Setpoints page 2.</p> <p>Setpoints page 8.</p>
<p>10. Phase instantaneous trips not operating.</p>	<ol style="list-style-type: none"> 1. Check that the phase instantaneous trips are enabled in setpoints. 2. Check the phase instantaneous trip level setpoint and verify that the current is exceeding this level. 	<p>Setpoints page 2.</p> <p>Setpoints page 2.</p>

MALFUNCTION	ACTION	REFERENCE
	<ol style="list-style-type: none"> 3. Read the phase instantaneous trip delay and verify that the overcurrent condition is present for longer than this time. 4. Ensure that the trip relay wiring to the breaker is correct at terminals 41 and 57. 	<p>Setpoints page 2.</p> <p>Relay wiring diagram.</p>
<p>11. Ground fault protection not energizing trip relay(s).</p>	<ol style="list-style-type: none"> 1. Verify that the ground fault sensing is enabled in setpoints mode. 2. Check that the sensing system selected in setpoints, either Residual or Zero sequence, corresponds to your system. 3. For Zero sequence sensing systems, verify that the CT primary ratio entered in setpoints mode correspond to the installed CT. 4. Check that the correct ground fault overcurrent pickup has been entered in setpoints. 5. Verify that the correct protection curve, pickup level and curve number have been selected for the level of ground fault encountered. 6. Ensure that the fault current is present for longer than the time necessary to trip according to the selected time/overcurrent curve. 7. Check all system wiring. 8. Perform calibration mode relay test to verify the operation of the trip relay. 	<p>Setpoints page 3.</p> <p>Setpoints page 3.</p> <p>Setpoints page 3.</p> <p>Setpoints page 3.</p> <p>Setpoints page 3 and Instruction manual section 6.</p> <p>Setpoints page 3 and Instruction manual section 6.</p> <p>Relay wiring diagram.</p> <p>Setpoints page 8.</p>
<p>12. Ground fault protection causes trip but no alarm.</p>	<ol style="list-style-type: none"> 1. Check that the ground fault alarm is enabled in setpoints. 2. Identify the relay to which the alarm has been assigned from setpoints mode page 3. Ensure that it is correctly wired to the alarm annunciation. 3. Check that the ground fault alarm level is low enough to cause an alarm before the trip level is reached. 4. Read the ground fault alarm time delay and ensure that the alarm condition is present for longer than this time. Note that if the ground fault current level rises to the trip level before the timed period, a trip will occur before the alarm. 5. Perform calibration mode relay test to verify the operation of the assigned relay(s). 	<p>Setpoints page 3.</p> <p>Setpoints page 3 and relay wiring diagram.</p> <p>Setpoints page 3.</p> <p>Setpoints page 3.</p> <p>Setpoints page 8.</p>
<p>13. Ground fault instantaneous trips not operating.</p>	<ol style="list-style-type: none"> 1. Check that the ground fault instantaneous trips are enabled in setpoints. 	<p>Setpoints page 3.</p>

APPENDIX B



MALFUNCTION	ACTION	REFERENCE
	<ol style="list-style-type: none"> 2. Check the ground fault instantaneous trip level setpoint and verify that the current is exceeding this level. 3. Read the ground fault instantaneous trip delay and verify that the overcurrent condition is present for longer than this time. 4. Ensure that the trip relay wiring to the breaker is correct at terminals 41 and 57. 5. Perform calibration mode relay test to verify the operation of the trip relay. 	<p>Setpoints page 3.</p> <p>Setpoints page 3.</p> <p>Relay wiring diagram.</p> <p>Setpoints page 8.</p>
<p>14. No display for analog in signal in actual values mode.</p>	<ol style="list-style-type: none"> 1. Verify that the analog input feature is enabled. 2. Check that the analog input signal appears at relay terminals 23 and 24. 	<p>Setpoints page 5.</p> <p>Relay wiring diagram.</p>
<p>15. Displayed scaled value for analog input incorrect.</p>	<ol style="list-style-type: none"> 1. Check maximum and minimum scale factors. 2. Check that the analog input current range being input into the relay is within the limits of 4 to 20 mA. 	<p>Setpoints page 5.</p>
<p>16. Analog input trip not operating.</p>	<ol style="list-style-type: none"> 1. Verify that the analog input trip is enabled. 2. Verify that the trip signal has been assigned to the intended relay in the setpoints mode. 3. Check the assigned relay wiring to the breaker trip circuit. 4. Read the scaled value of the analog input in the actual values page 2, and ensure that it is above the trip level setpoint entered in setpoints mode. 5. Read the analog input trip time delay from the setpoints mode page 5, and ensure that the analog signal is above the trip level for longer than this time. 6. Perform calibration mode relay test to verify the operation of the trip relay. 	<p>Setpoints page 5.</p> <p>Setpoints page 5.</p> <p>Relay wiring diagram.</p> <p>Actual Values page 2, and setpoints page 5.</p> <p>Setpoints page 5.</p> <p>Setpoints page 8.</p>
<p>17. Analog input alarm not operating.</p>	<ol style="list-style-type: none"> 1. Verify that the analog input alarm is enabled. 2. Verify that the intended relay has been selected in the setpoints and that the selected relay is correctly wired to the alarm circuit. 3. Read the scaled value of the analog input in the actual values page 2, and ensure that it is above the alarm level setpoint entered in setpoints mode. 4. Read the analog input alarm time delay from the setpoints mode page 5, and ensure that the analog signal is above the trip level for longer than this time. 	<p>Setpoints page 5.</p> <p>Setpoints page 5 and relay wiring diagram.</p> <p>Actual Values page 2, and setpoints page 5.</p> <p>Setpoints page 5.</p>

MALFUNCTION	ACTION	REFERENCE																								
	5. Perform the calibration mode relay test to verify the operation of the assigned relay(s).	Setpoints page 8.																								
18. Analog output parameter not operating.	1. Check that the circuit connected to the Analog out terminal and verify that no external voltage larger than 30V (DC or peak to peak AC)is present. 2. Verify the requested parameter is as intended by viewing the analog output parameter message. a) If the selected analog output parameter is feeder frequency, phase or ground fault current or phase voltage these values can be read from the relevant page in the actual values mode. Verify from the actual values that the parameter does not have a value of zero, in which case no output will be present. b) If the selected analog output parameter is external analog select, then the analog output is determined by the input presented at the Analog Select terminals. Refer to the Instruction manual to determine the correct inputs to these terminals for any output.	Relay wiring diagram. Setpoints page 6. Instruction Manual section 5. Setpoints page 6.																								
19. No MTM communication.	1. Check MTM communication setpoint. 2. Check MTM default power switch. The MTM can be powered from the PTs or line. The default is line; the switch must be toggled for PT.	Setpoint page 4. See MTM power selection diagram.																								
20. Poor Open Delta voltage readings.	1. Check and verify the secondary voltages measured at 565/575 terminals 35, 36, 37 and 38. 2. Check the wiring. See the following table for commonly made errors. The correct nominal voltage in each example should be 4.16 kV. <table border="1" data-bbox="561 1297 1125 1507" style="margin: 10px auto;"> <thead> <tr> <th>V_{AB}</th> <th>V_{BC}</th> <th>V_{CA}</th> <th>PROBLEM</th> </tr> </thead> <tbody> <tr> <td>4.16 kV</td> <td>0.00 kV</td> <td>4.16 kV</td> <td>VT connection setpoint programmed as Wye or Delta/Wye</td> </tr> <tr> <td>2.50 kV</td> <td>2.50 kV</td> <td>4.16 kV</td> <td>V_B to V_N jumper missing at relay</td> </tr> <tr> <td>4.16 kV</td> <td>4.16 kV</td> <td>7.00 kV</td> <td>V_A swapped with V_B at one PT.</td> </tr> <tr> <td>4.16 kV</td> <td>4.16 kV</td> <td>7.00 kV</td> <td>V_B swapped with V_C at one PT.</td> </tr> <tr> <td>4.16 kV</td> <td>4.16 kV</td> <td>3.90 kV</td> <td>V_A swapped with V_C at one relay.</td> </tr> </tbody> </table>	V_{AB}	V_{BC}	V_{CA}	PROBLEM	4.16 kV	0.00 kV	4.16 kV	VT connection setpoint programmed as Wye or Delta/Wye	2.50 kV	2.50 kV	4.16 kV	V_B to V_N jumper missing at relay	4.16 kV	4.16 kV	7.00 kV	V_A swapped with V_B at one PT.	4.16 kV	4.16 kV	7.00 kV	V_B swapped with V_C at one PT.	4.16 kV	4.16 kV	3.90 kV	V_A swapped with V_C at one relay.	
V_{AB}	V_{BC}	V_{CA}	PROBLEM																							
4.16 kV	0.00 kV	4.16 kV	VT connection setpoint programmed as Wye or Delta/Wye																							
2.50 kV	2.50 kV	4.16 kV	V_B to V_N jumper missing at relay																							
4.16 kV	4.16 kV	7.00 kV	V_A swapped with V_B at one PT.																							
4.16 kV	4.16 kV	7.00 kV	V_B swapped with V_C at one PT.																							
4.16 kV	4.16 kV	3.90 kV	V_A swapped with V_C at one relay.																							
21. Undervoltage Trip feature does not work.	1. Check and verify that all the required phases are below the programmed threshold. 2. For a Wye configuration, one phase must be below the programmed threshold for an alarm while two phases are required to be below the threshold for a trip. The same is true for an Open Delta connection, but with the additional criteria that the phases must be measured (V_{AB} & V_{BC}) and not calculated (V_{AC}).	Setpoints page 9.																								

MALFUNCTION	ACTION	REFERENCE
	<p>3. Check breaker position. Due to applications where the potential transformers are located on the local side of the breaker, the 565/575 must see the breaker closed at terminals 9, 10, and 11 before issuing an undervoltage trip. This prevents the relay from issuing an undervoltage trip each time the breaker is opened.</p>	
<p>22. "Illegal Access," even with the jumper installed.</p>	<p>1. Check if access setpoint is disabled via communication with Relaycom®.</p> <p>Functioning in series with the hardware access jumper is the relay's Setpoint Access/Software Code setpoint that is only visible when the Security Feature setpoint is enabled. When the 565/575 is shipped from the factory, the Setpoint Access/Software Code setpoint is enabled and the Security Feature is disabled. Therefore, you cannot see the Setpoint Access/Software Code setpoint and only the hardware jumper at terminals 33 and 34 will determine whether you can store setpoints.</p> <p>If you now establish communications with a 565/575 using Relaycom®, the Setpoint Access/Software Code setpoint can be disabled independent of the Security Feature setpoint. Relaycom® calls this "Local Setpoint Access." Suppose one disabled "Local Setpoint Access" using Relaycom®. The next time one tries to store a new setpoint using the 565/575 keypad, they will get the "Illegal Access" message even though the access jumper is in place. This will cause confusion because the Security Feature is disabled and this normally means the Setpoint Access/Software Code setpoint is enabled.</p> <p>This is not the case. The Setpoint Access/Software Code setpoint is disabled and you cannot view it because the Security Feature setpoint is also disabled. To make matters worse, you cannot enable the Security Feature setpoint to allow you to enable the Setpoint Access/Software Code setpoint. Setpoint access is disabled. The only way to re-establish setpoint access is to enable "Local Setpoint Access" in Relaycom®.</p>	<p>Setpoints page 1.</p>

Block Diagrams

The figures on the following pages show the 565/575 Relay hardware block diagrams. The following shows the name and contents of each figures:

Figure Contents

- C1 System controller block diagram, part 1/2.
- C2 System controller block diagram, part 2/2.

www.ElectricalPartManuals.com

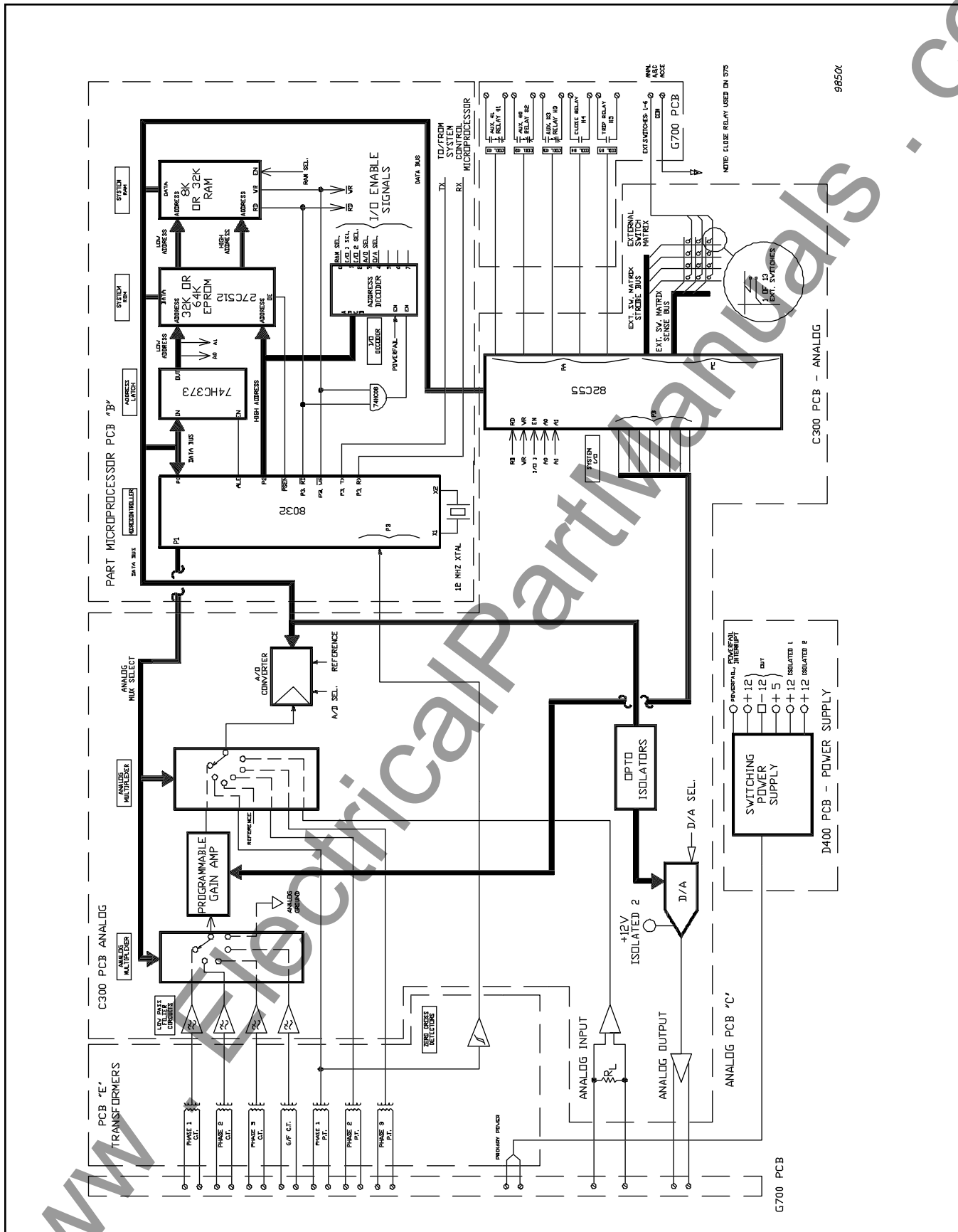
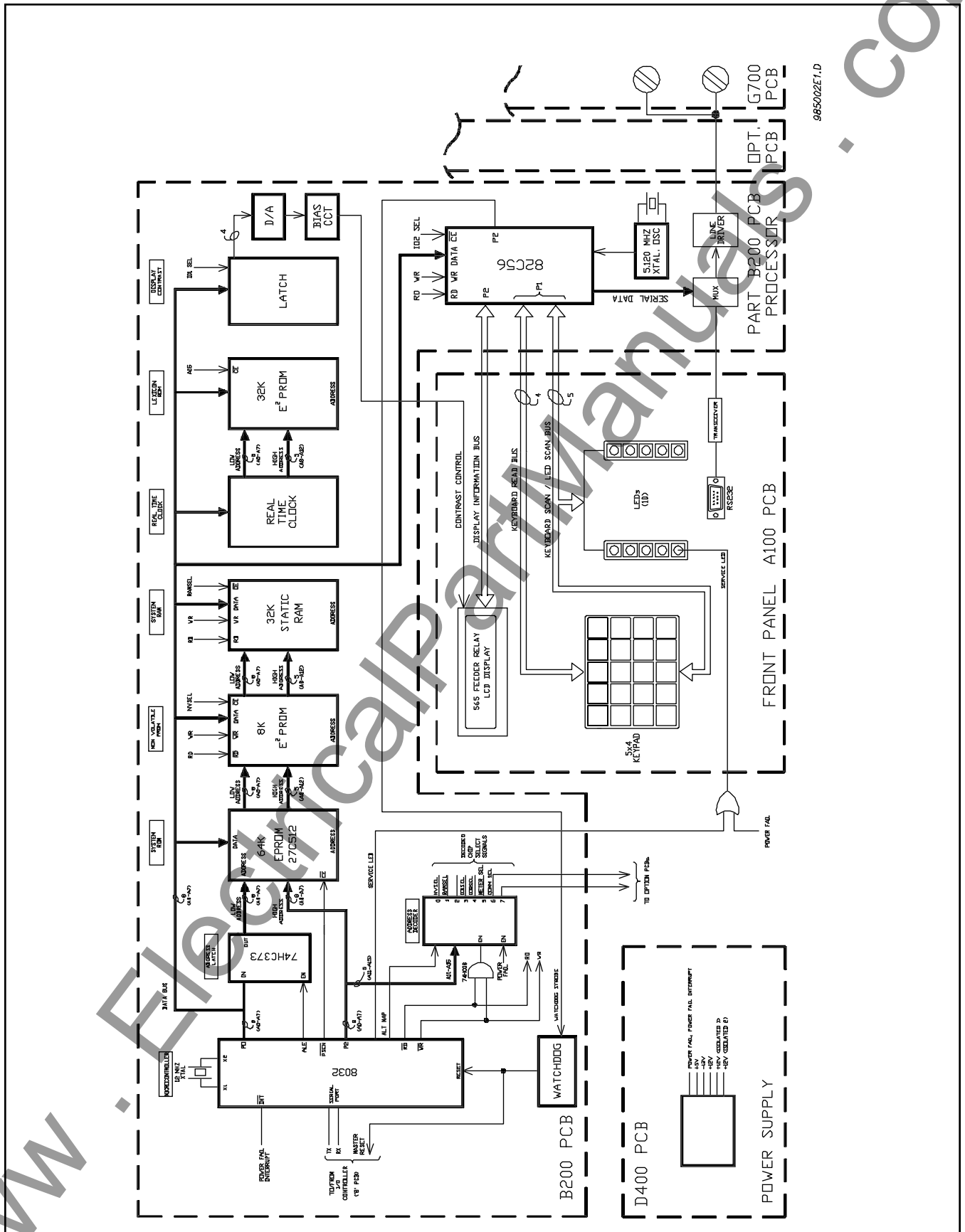

Figure C1. System Controller Block Diagram (1/2)



985002E1.D

Figure C2. System Controller Block Diagram (2/2)

www.ElectricalPartManuals.com

Figure 1.1	Order Codes	1-2
Figure 2.1	Mounting Details.....	2-2
Figure 2.10	565/575 Rear Panel Layout	2-15
Figure 2.2	Mounting Arrangement with Relay Collar	2-3
Figure 2.3	Computer Interface Cable for RelayCom Package	2-4
Figure 2.4	Removal of Hi-Pot Screw	2-6
Figure 2.5	565/575 Relay Typical Wiring.....	2-8
Figure 2.6	Voltage Sensing Wire	2-9
Figure 2.7A	565/575 with MTM CT and Open Delta VT Typical Wiring	2-10
Figure 2.7B	565/575 with MTM CT and Wye VT Typical Wiring.....	2-11
Figure 2.8A	Open Delta VT and CT MTM Typical Wiring	2-12
Figure 2.8B	Wye VT and CT MTM Typical Wiring	2-13
Figure 2.9	MTM Mounting Dimensions.....	2-14
Figure 3.1	Normal Inverse Time/Phase Overcurrent Curve	3-2
Figure 3.2	Moderately Inverse Time/Phase Overcurrent Curve	3-3
Figure 3.3	Very Inverse Time/Phase Overcurrent Curve	3-4
Figure 3.4	Extremely Inverse Time/Phase Overcurrent Curve	3-5
Figure 3.5	Normal Inverse Time/Ground Overcurrent Curve	3-6
Figure 3.6	Moderately Inverse Time/Ground Overcurrent Curve	3-7
Figure 3.7	Very Inverse Time/Ground Overcurrent Curve.....	3-8
Figure 3.8	Extremely Inverse Time/Ground Overcurrent Curve	3-9
Figure 4.1	565/575 Relay Front Panel.....	4-4
Figure 8.1	Secondary Injection Test Setup	8-2
Figure C1.	System Controller Block Diagram (1 of 2)	C-2
Figure C2.	System Controller Block Diagram (2 of 2)	C-3

www.ElectricalPartManuals.com

INTENT

This manual describes the function, operation and use of the Multilin Model 565/575 Feeder Management Relays.

REVISION HISTORY

<u>Manual Part No.</u>	<u>Software Revision</u>	<u>Release Date</u>
1601-0017-E1	E2.2	02/26/92
1601-0017-E2	E2.3	05/28/92
1601-0017-E3	E2.4	09/17/92
1601-0017-E4	E2.4	03/28/93 (manual format changed)
1601-0017-E5	E2.4	04/26/95
1601-0017-E6	E2.73	??/??/96 (565 & 575 combined into 1 manual)

www.ElectricalPartManuals.com

GE MULTILIN RELAY WARRANTY

General Electric Multilin Inc. (GE Multilin) warrants each relay it manufactures to be free from defects in material and workmanship under normal use and service for a period of 24 months from date of shipment from factory.

In the event of a failure covered by warranty, GE Multilin will undertake to repair or replace the relay providing the warrantor determined that it is defective and it is returned with all transportation charges prepaid to an authorized service centre or the factory. Repairs or replacement under warranty will be made without charge.

Warranty shall not apply to any relay which has been subject to misuse, negligence, accident, incorrect installation or use not in accordance with instructions nor any unit that has been altered outside a GE Multilin authorized factory outlet.

GE Multilin is not liable for special, indirect or consequential damages or for loss of profit or for expenses sustained as a result of a relay malfunction, incorrect application or adjustment.

For complete text of Warranty (including limitations and disclaimers) refer to GE Multilin Standard Conditions of Sale.

www.ElectricalPartManuals.com