

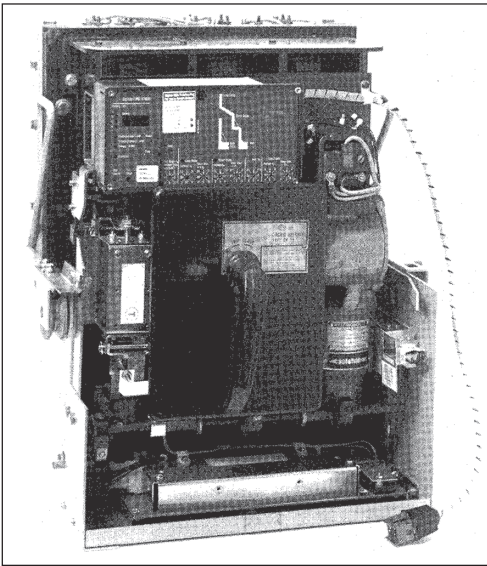

## Digitrip Retrofit System for Westinghouse DK-25 Breakers



### SAFETY PRECAUTIONS

#### WARNING

**POWER CIRCUIT BREAKERS ARE EQUIPPED WITH HIGH SPEED, HIGH ENERGY OPERATING MECHANISMS. THE BREAKERS AND THEIR ENCLOSURES ARE DESIGNED WITH SEVERAL BUILT-IN INTERLOCKS AND SAFETY FEATURES INTENDED TO PROVIDE SAFE AND PROPER OPERATING SEQUENCES. TO PROVIDE MAXIMUM PROTECTION FOR PERSONNEL ASSOCIATED WITH THE INSTALLATION, OPERATION, AND MAINTENANCE OF THESE BREAKERS, THE FOLLOWING PRACTICES MUST BE FOLLOWED. FAILURE TO FOLLOW THESE PRACTICES MAY RESULT IN DEATH, PERSONAL INJURY, OR PROPERTY DAMAGE.**

- Only qualified persons, as defined in the National Electric Code, who are familiar with the installation and maintenance of power circuit breakers and their associated switchgear assemblies should perform any work associated with these breakers.

- Completely read and understand all instructions before attempting any installation, operation, maintenance, or modification of these breakers.
- **Always turn off and lock out the power source feeding the breaker prior to attempting any installation, maintenance, or modification of the breaker. Do not use the circuit breaker as the sole means for isolating a high voltage circuit. Follow all lockout and tagging rules of the National Electric Code and all other applicable codes, regulations, and work rules.**
- Do not work on a closed breaker or a breaker with the closing springs charged. Trip (open) the breaker and be sure the stored energy springs are discharged before performing any work. The breaker may trip open or the charging springs may discharge, causing crushing or cutting injuries.
- For drawout breakers, trip (open), and then remove the breaker to a well-lit work area before beginning work.
- Do not perform any maintenance: including breaker charging, closing, tripping, or any other function which could cause significant movement of the breaker while it is on the extension rails. Doing so may cause the breaker to slip from the rails and fall, potentially causing severe personal injury to those in the vicinity.
- **Do not leave the breaker in an intermediate position in the switchgear cell. Always leave it in the connected, disconnected, or (optional) test position. Failure to do so could lead to improper positioning of the breaker and flashover, causing death, serious personal injury, and / or property damage.**
- **Do not defeat any safety interlock. Such interlocks are intended to protect personnel and equipment from damage due to flashover and exposed contacts. Defeating an interlock could lead to death, severe personal injury, and / or property damage.**

## INTRODUCTION

Cutler-Hammer Digitrip Retrofit Kits are available in a number of configurations that provide a wide range of features. The Digitrip System starts with the 510 Basic Kit which offers true RMS sensing, overcurrent protection, and self-testing features. Advanced Digitrip Retrofit Kits feature zone interlocking, digital alphanumeric displays, remote alarm signals, PowerNet communications, energy monitoring capabilities, power factors, and harmonic content measurements.

Table 1 provides a quick reference of the components supplied with each level of Retrofit Kit. Before beginning the Retrofit process, take a minute to review the information contained in Table 1. It is important that the Retrofitter understands which

level of Retrofit Kit is to be installed and which components are included with the Kit.

The instructions contained in this manual cover the installation of all levels of Retrofit Kit. If the Kit you are installing does not contain a certain component, skip the instructions for that component and proceed to the next.

Throughout the Retrofit process, refer to the Torque Tables at the back of this manual for specific torque values.

If you have any questions concerning the Retrofit Kit and / or the Retrofit process, contact Cutler-Hammer at: 1-800-937-5487.

**Table 1 Available Retrofit Kits**

Components	510 Basic	510 with Zone Interlock	610	810	910
Trip Unit					
Rating Plug					
Auxiliary Current Transformer (CT) Module					
Auxiliary CT Harness					
Sensors					
Sensor Harness					
Direct Trip Actuator (DTA)					
Mounting Brackets and Hardware					
External Harness	Plug	1 Connector Harness	2 Connector Harness	4 Connector Harness	4 Connector Harness
Cell Harness					
Potential Transformer (PT) Module					
Auxiliary Switch					

**STEP 1:** Before attempting to remove the Breaker, or perform any Retrofit operation, be sure to read and understand the Safety Precautions on the inside front cover of this manual. In addition, be sure to read and understand the Retrofit Application Data supplied with the kit.

- A. Trip the Breaker and remove it from the cell. Move the Breaker to a clean, well-lit work bench.

To begin the Retrofit process, refer to the components list at the rear of this manual. Lay out the components and hardware according to the steps outlined. The components and hardware will be used to complete each step of the process.

**STEP 2:** Following the Westinghouse DK-25 Instruction Manual originally supplied with the Breaker, perform the following procedures.

- A. Remove the three bottom Finger Clusters from the rear of the Breaker. Set them aside for future use.
- B. Remove and scrap the three Electromechanical Trip Devices from the bottom front of the Breaker.
- C. Remove and scrap the two bolts that attach each Trip Coil to the bottom of the Pole Units.
- D. From the rear of the Breaker, remove the large hex nut and Locking Plate from each bottom stud. Lay these parts aside for future use.
- E. Remove each bottom stud, with the Trip Coil attached, from the bottom front of the Breaker.

**STEP 3:** **Note:** During Steps 3-A, B, and C, care should be taken not to damage the threads on the studs.

- A. Clamp one bottom stud in a vice.
- B. Using a hacksaw, carefully cut the Trip Coil off flush with the front of the bottom stud.

*Note: Care should be taken not to damage the silver plating while sawing.*

- C. Carefully file the area of the cut smooth and flush with the front stud, taking care not to damage the silver plating.
- D. Repeat Steps 3-A, B, and C for the two remaining bottom studs and Trip Coils.

Drilling Plan "A"

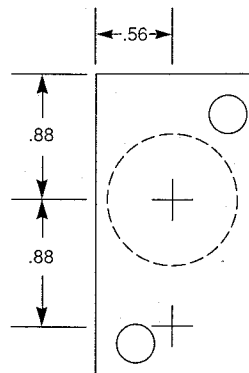

- E. Using Drilling Plan "A" mark the two holes that are to be drilled in each bottom stud.

*Note: One hole is drilled into the center of the round part of the stud, while the other is drilled through the flange.*

- F. Using a drill press, and with the stud securely held in a vice, drill a .257" dia. hole through the flange. Again using a .257" dia. drill bit, drill a hole in the center of the round part of the stud to a depth of 1".

**STEP 3:**  
**(continued)**

- G. Repeat Steps 3-E and F on the two remaining bottom studs.
- H. Tap the holes, drilled in each bottom stud, with a .312"-18 tap.
- I. From the front of the Breaker and with the flange facing downward, slide the round end of each bottom stud back through the holes in the Breaker Back Plate.
- J. From the rear of the Breaker, slide a Locking Plate (removed in Step 2-D) on each bottom stud. The lip of each Locking Plate must be on the bottom and facing into the Breaker back plate.
- K. Thread a large hex nut (removed in Step 2-D) on each bottom stud approximately three turns. Do not tighten the hex nut at this time.

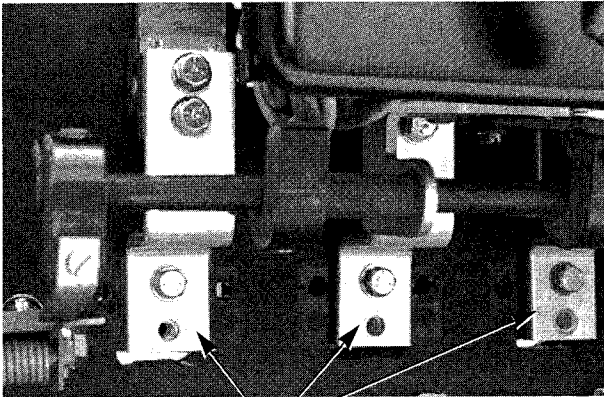
**STEP 4:**

Copper Connector &amp; Spacer-Plate

- A. Using the hardware provided, install a Copper Adapter and spacer between the bottom of each Pole Unit and bottom stud as shown. The longer leg of the Adapter faces up and to the front of the Breaker. The spacer fits between the bottom stud, and the Adapter fits to the bottom of each pole unit.

*For RMS/R 810 & 910 kits only. Do not tighten one bolt on each Phase at this time. They will be used to connect the PT wires later in the Retrofit process.*

- B. Tighten each of the three large hex nuts on the bottom studs on the rear of the Breaker.
- C. Install the Finger Clusters (removed in Step 2-A) on the bottom studs.

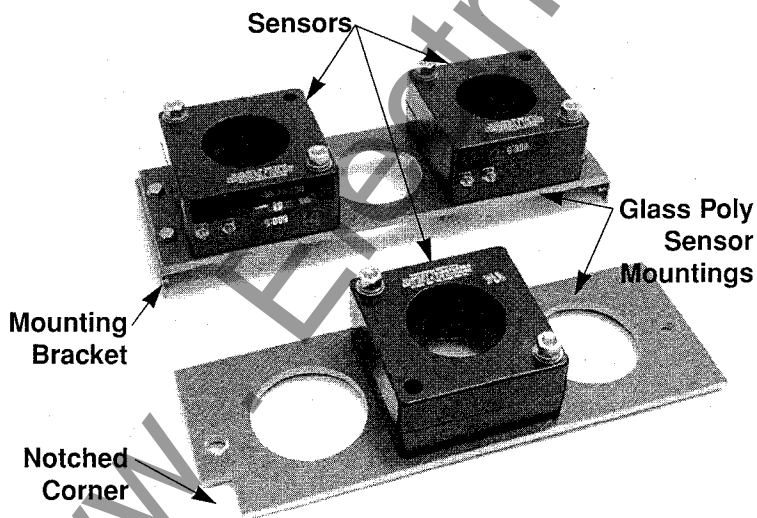
**STEP 5:**

- A. Select the Glass Poly Sensor Mounting with two holes in each end and no notched corner. Install a Mounting Bracket on each end as shown, using the hardware supplied (bolts, flat washers, lock washers, and nuts).
- B. Using the hardware provided, mount a Sensor over each outer hole. Insert the bolts through the Glass Poly Sensor Mounting first, and then through the Sensors, as shown, positioned with nameplate facing outward and terminals facing downward. The Sensors are to be mounted on the opposite side of the Glass Poly Sensor Mounting from the Mounting Brackets.

**STEP 5:** C. Position the other Glass Poly Sensor Mounting in front of you, with the notched corner to the lower left. Using the hardware provided, mount a Sensor over the center hole, inserting the bolts through the Glass Poly Sensor Mounting first, then through the Sensors, as shown, positioned with the nameplate facing outward and the terminals facing up.

**STEP 6:** A. Drill each side of the Breaker frame per Drilling Plan "B".  
 B. Drill the left side of the Breaker per Drilling Plan "C".  
 C. Drill the right side of the Breaker per Drilling Plan "D".

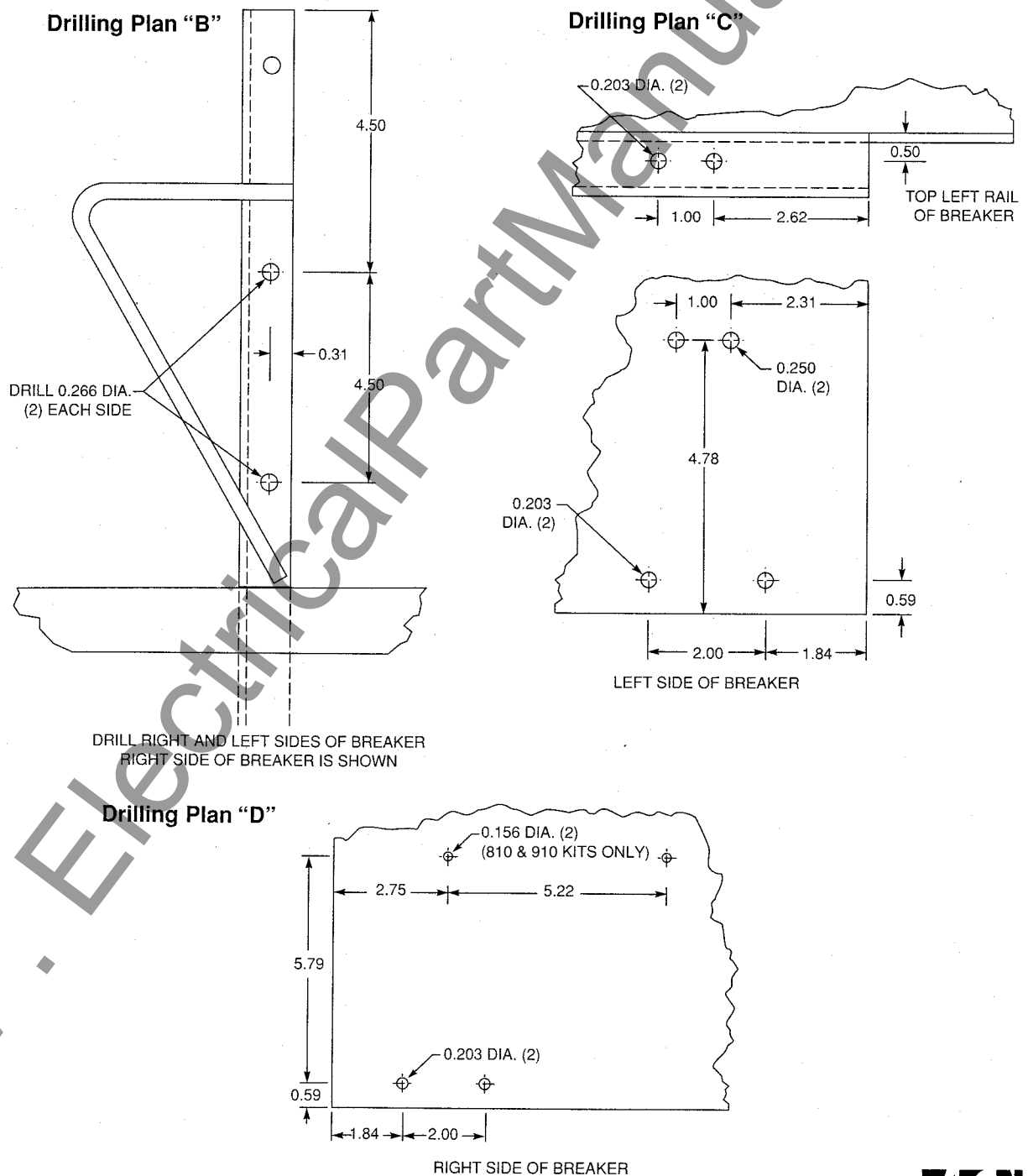

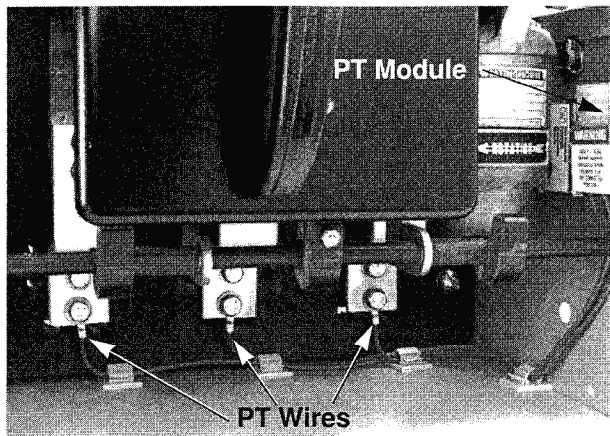
**STEP 7:**

For RMS/R 810 & 910 kits only.

A. Using the holes drilled in Step 6-C and the hardware provided, mount the PT Module on the right side of the Breaker, with the insulation placed between the PT Module and the side of the Breaker as shown. Position the new Warning Label over the existing one so that the lettering is right side up.

- B. Temporarily route the PT Module wires along the bottom right side, then along the back of the Breaker to the bottom studs. The wires are marked for connection to Phases 1, 2, and 3 with corresponding numbers.
- C. Cut each of the three wires to a length suitable for attachment to the corresponding bottom stud that mounts the Copper Adapter to each Phase.
- D. After cutting the wires to length, strip each wire .250" and install a .312" ring terminal.
- E. Remove the bottom bolt that connects the Copper Adapter to the bottom stud of each Phase. This would be the bolt left loose in Step 4. Attach each wire to the correct Phase with the bolts just removed. Secure the wires along the bottom right, then along the back with the wire ties and wire clips supplied.

*Note: To insure proper adhesion, clean the surface of the Breaker bottom before installing the wire clips.*

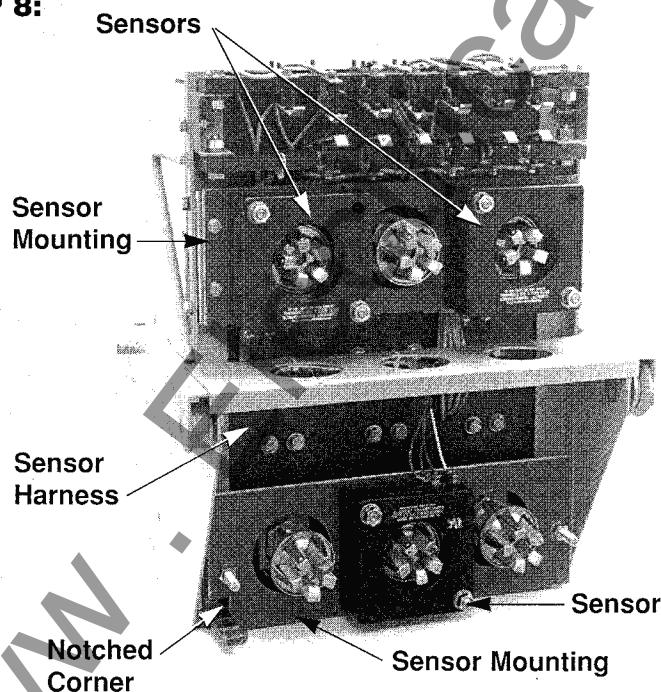
**STEP 8:**

- A. Remove and scrap the bottom bolt from each side of the Breaker frame. Replace with the longer hardware provided.
- B. Slide the Sensor Assembly, with two Sensors attached, over the top studs with the terminals facing down and the Sensors facing you, as shown. Using the hardware supplied, bolt the Sensor Mounting in place using the holes drilled in Step 6-A and those in the Mounting Brackets.

**STEP 8:**  
(continued)

Detail "A"

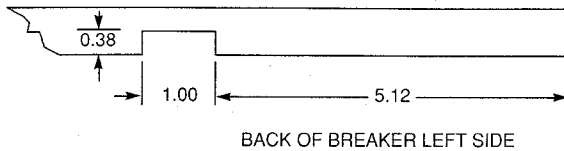

- C. Notch the bottom rear flange of the Breaker per Detail "A".
- D. Thread two hex nuts all the way on each of the two screws installed in Step 8-A and protruding from the back on each side of the Breaker. Tighten the nuts.

- E. Slide a flat washer on the screws and against the nuts just tightened. Slide the Sensor Assembly, with one Sensor attached over the bottom studs as shown, with the terminals facing up and the notched corner on the bottom left. The screws protruding through the back plate go through the mounting holes.
- F. With the hardware supplied, slide a flat washer, lock washer, and tighten a nut on each of the screws to hold the bottom Sensor Assembly in place.
- G. Route the Sensor Harness through the hole in the Breaker back plate. Connect the ring terminals to the terminals of the Sensors, as shown, and as per the Retrofit Application Data.

*Note: The long tan and green wires are for a remote Neutral Sensor on a 4W Ground Breaker. They should be removed if not required.*

*Sensor Style No. 8259A40H01 X1-X2 = 600/5*

*Sensor Style No. 8259A39H01 X1-X2 = 400/5*

*Sensor Style No. 8259A38H01 X1-X2 = 200/5*

- H. After connecting the terminals to the Sensors, use the supplied wire ties to dress the Sensor Harness and attach it to the Breaker frame.

**STEP 9:**

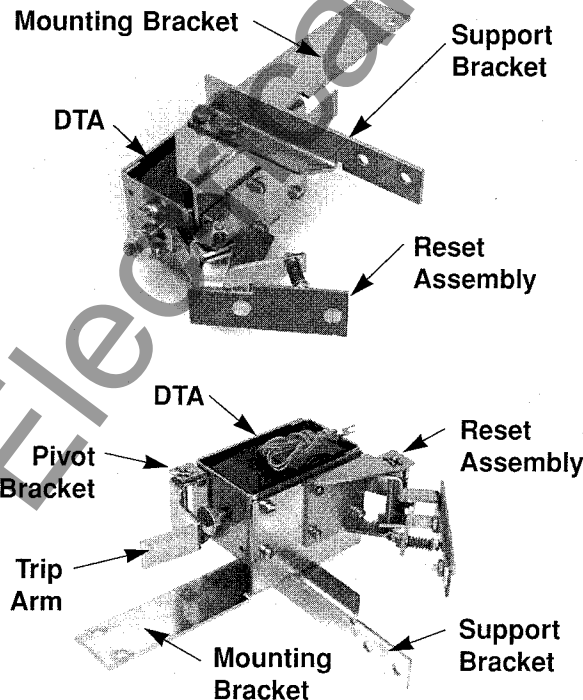

- A. Using the hardware provided, mount the Mounting Bracket and the Reset Assembly to the Direct Trip Actuator (DTA) as shown. The fork of the Reset Assembly is to be positioned around the DTA shaft. Apply Loctite<sup>®</sup> 243 then thread the flange nut all the way on the DTA shaft.
- B. Again using the hardware provided, mount the Pivot Bracket to the opposite end of the DTA as shown. Align the holes in the Trip Arm with the holes in the Pivot Bracket and insert the Pivot shaft through these holes. Tighten an "X" washer to each end of the shaft. Again using Loctite<sup>®</sup> 243, thread a flange nut even with the end of the DTA shaft. The flat of the flange nut should be positioned at the end of the DTA shaft as shown.

**STEP 9:**  
(continued)

- C. Attach the Support Bracket to the Mounting Bracket with the hardware provided, as shown. Do not tighten at this time.

**STEP 10:**

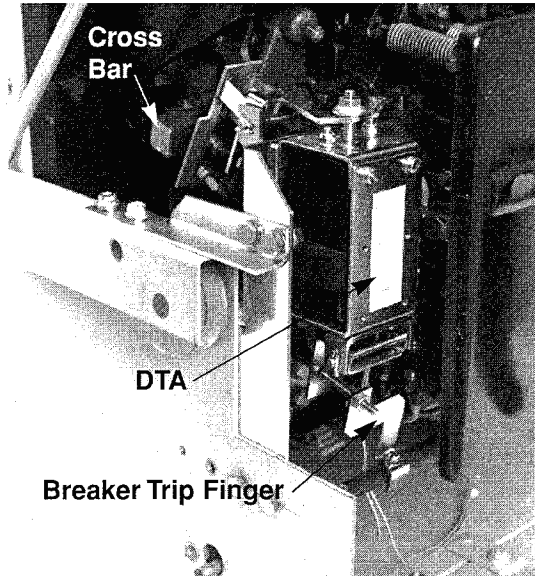

- A. Loosen the clamping bolts that attach the Cross Bar to each Phase. Slide the Cross Bar to the left until .250" extends out of the right side from Phase 3. Tighten the clamping bolts.
- B. Remove the Trip Finger on the left side of the Trip Bar, located next to the sleeve on the Trip Bar.
- C. Using holes drilled in Step 6-B and the hardware provided, position the DTA Assembly on the left side sheet of the Breaker as shown. Using the hardware provided, mount the DTA Assembly to the Breaker. The Reset Assembly will be against the Cross Bar and the Trip Arm will hang free.

- D. Using the hardware provided, mount the Breaker Trip Finger onto the Breaker Trip Bar as shown. Adjust the Trip Screw so that there is approximately .060" between the end of the DTA shaft flange nut and the Trip Arm of the DTA. Tighten the locking nut on the Trip Screw.
- E. Connect a 24V DC power supply to the DTA terminals (positive to positive and negative to negative). Close the Breaker manually. Energize the DTA to trip the Breaker, de-energize when the Breaker trips. Make certain that the DTA resets.

If the Breaker does not trip, adjust the Trip Screw on the Breaker Trip Finger. If the DTA fails to reset, adjust the spring tension on the Reset Assembly. Repeat until the trips and resets are sure and positive every time.

- STEP 11:** A. Install the Mounting Brackets on the bottom of the Aux. CT Module. The longer one goes on the same side as the white plug and the shorter one goes on the same side as the 7-point Terminal Block.

**Note:** The following instructions refer to the wiring diagrams in the Retrofit Application Data. Please refer to them for proper connection and applications.

**Note:** To make the following wiring connections, the Aux. CT Module should be positioned in front of the Breaker. The Aux. CT Module will be mounted in the Breaker later in the Retrofit Process.

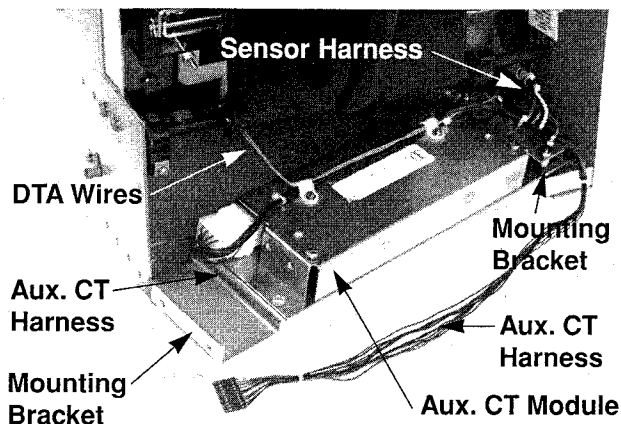
**STEP 11:**

B. Remove the cover from the 7-point Terminal Block on the Aux. CT Module. Connect the Snap Spade terminals of the Sensor Harness to the proper terminals of the 7-point Terminal Block.

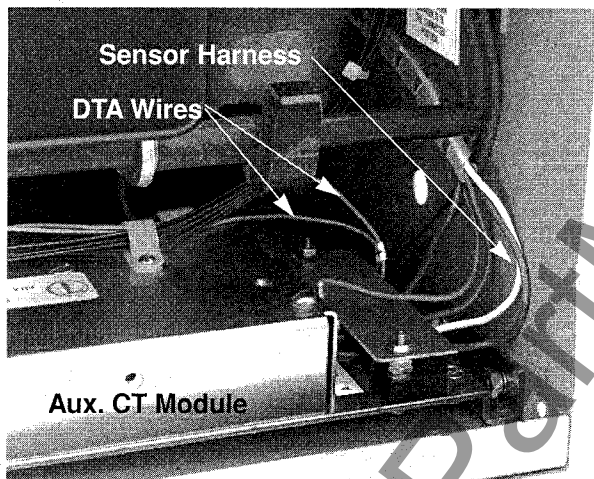

C. Using the hardware provided, connect the green wire (ring terminal) to one of the side threaded holes on the Aux. CT Module cover.

D. Route the DTA wires behind the Breaker Trip Shaft over to the 7-point Terminal Block as shown. Connect the wire marked with + to the "OP" terminal and the unmarked wire to the "ON" terminal.

E. Replace the Terminal Block Cover.

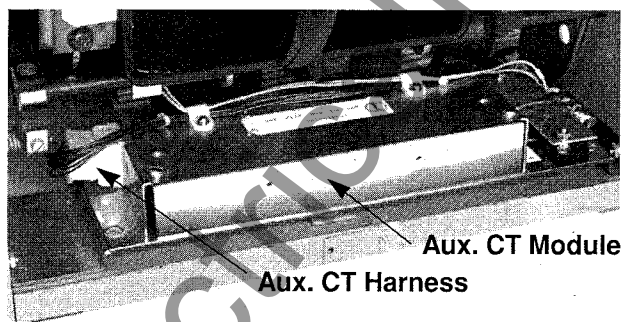

F. Plug the Aux. CT Harness into the white socket of the Aux. CT Module. Route the Aux. CT Harness and DTA wires across the Aux. CT Module as shown. Using the cable clamps and hardware supplied, attach the Aux. CT Harness and DTA wires in place to the Aux. CT Module cover as shown.

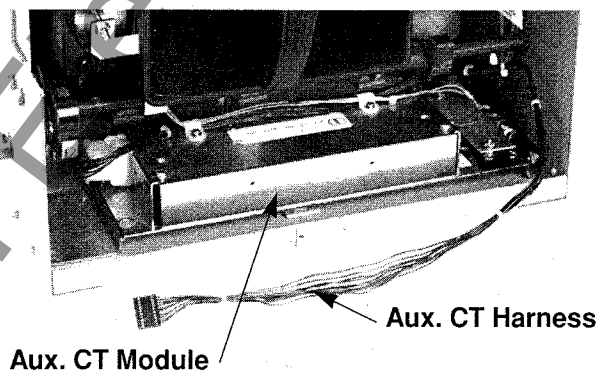

G. Using the holes drilled in Steps 6-B and C, and the hardware provided, mount the Aux. CT Module to the sides of the Breaker as shown.

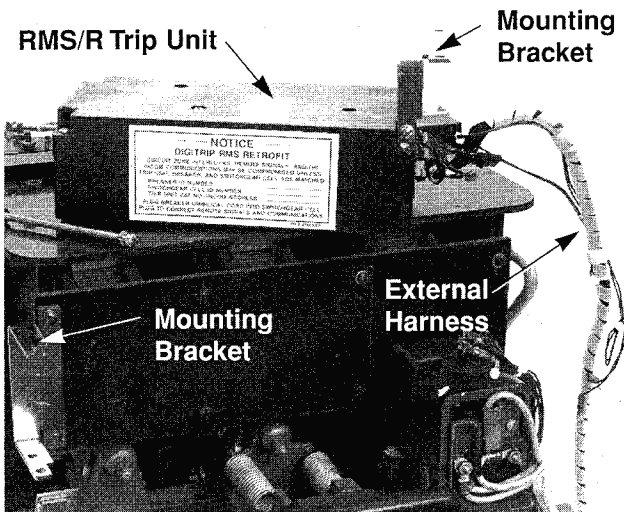
**STEP 12:**

*Note: For RMS/R 510 Basic Retrofit Kits - The External Harness is the plug pictured here. It is to be plugged into the right side of the Trip Unit in Step 12-B.*

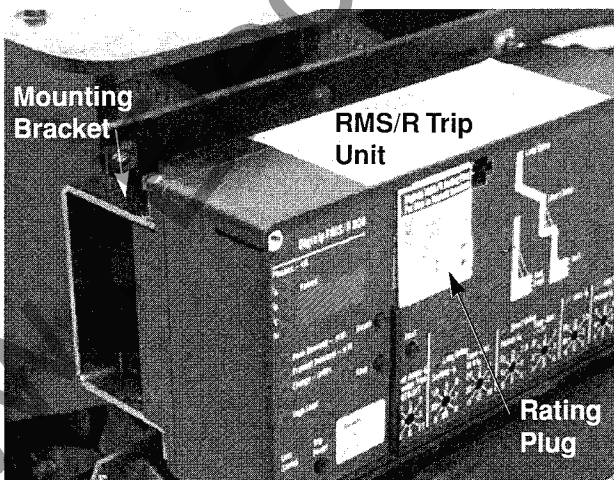
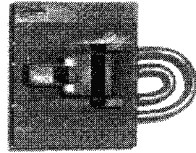

- A. Using a 4" long screw, flat washers, lock washer, and hex nut provided, install a Mounting Bracket onto the right rear holes of the RMS/R Trip Unit. The mounting pad of the Mounting Bracket will be to the right while the mounting legs for the Trip Unit will be to the left.
  - B. Install the External Harness to the right side of the RMS/R Trip Unit.
  - C. From the front left side of the Arc Chute Cover, remove the first set of screws.
  - D. Using the two screws just removed, mount the left RMS/R Trip Unit Mounting Bracket to the Arc Chute Cover. The mounting pad of the Mounting Bracket will be to the right while the mounting legs for the Trip Unit will be to the left.
  - E. Remove the two screws from the front cover that fasten to the Arc Chute Insulator between No. 2 and No. 3 Arc Chutes. Mount the right Trip Unit Mounting Bracket to the front cover, as shown, using the two screws just removed. Mount the left side of the Trip Unit to the Mounting Bracket installed in Step 12-D, using the 4" long screw, flat washers, lock washer, and nut.
- For RMS/R 810 & 910 kits only. Do not install the flat washer, lock washer, and nut on the bottom of the Mounting Bracket at this time.*
- F. Remove the RMS/R Trip Unit Cover and install the Rating Plug. Replace the cover.
  - G. Install the new Digitrip Nameplate on top of the Trip Unit as shown.

**STEP 13:**

*For RMS/R 810 & 910 kits only.*

- A. Cut 3.250" off the end of the Microswitch Lever. Mount the Microswitch to the Aux. Switch Mounting Bracket, as shown, with the hardware provided.

*Note: The heads of the screws will be to the inside of the Breaker, the order being screw, flat washer, switch, flat washer, Mounting Bracket, flat washer, lock washer, and nut.*

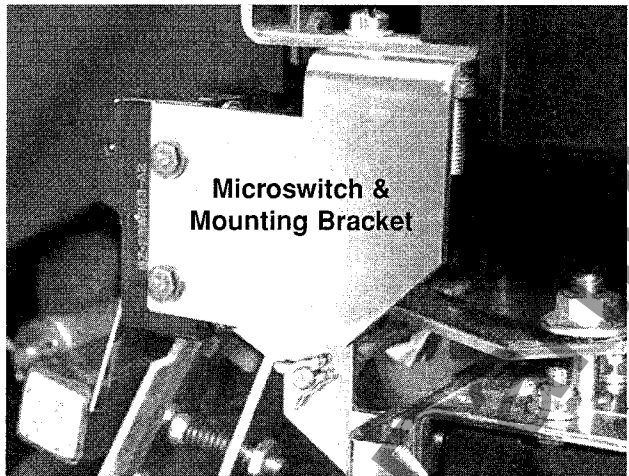

- B. Mount the Aux. Switch Assembly to the bottom of the RMS / R Trip Unit's left Mounting Bracket, as shown, using the 4" screw and hardware supplied.

*Note: Check for clearance between the heads of the screws on the Aux. Switch Assembly and the Reset Assembly.*

- C. Make certain the Microswitch is closed when the Breaker is open and that the lever operates freely as the Breaker opens and closes. Bend the lever slightly for adjustment as required.

**STEP 14:**

- A. Attach the External Harness to the Arc Chute's Cover as shown, with the two nylon wire clamps supplied and the existing screws from the cover.

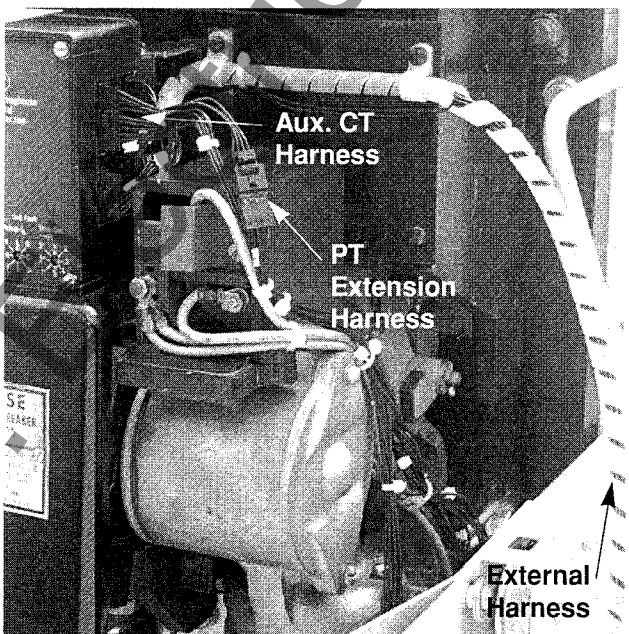

- B. Route and connect the Aux. CT Harness to the right side of the RMS / R Trip Unit.

- C. *For RMS/R 810 & 910 kits only.* Plug the connector from the External Harness into the socket of the PT Extension Harness. Route the PT Extension Harness along the Aux. CT Harness to the PT Module. Plug the connector of the PT Extension Harness into the socket of the PT Module. Use the supplied wire ties to bind the PT Extension and Aux. CT Harnesses together.

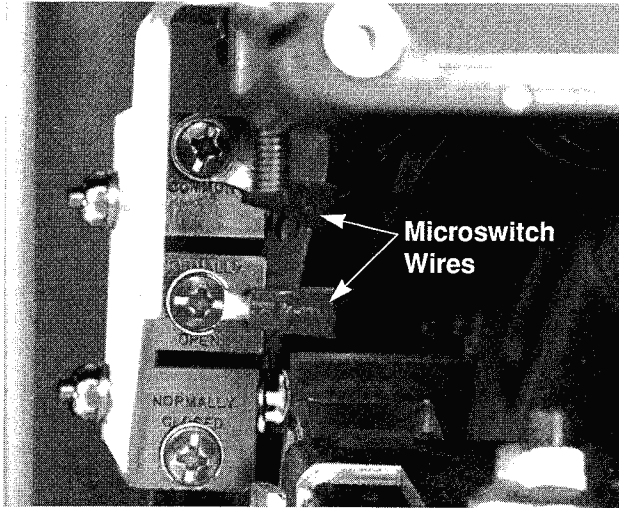
**STEP 14:**  
(continued)

- D. For RMS/R 810 & 910 kits only. Route the two wires, with ring terminals, from the External Harness behind the RMS/R Trip Unit to the Aux. Switch. Connect one wire to the normally open terminal and the other wire to the common terminal.
- E. Use nylon wire ties provided to dress the wiring and keep it away from any moving parts of the Breaker.

**STEP 15:** A. The Cell Harness is to be mounted in the Breaker Cell. The connector end is to be mounted on the right front side of the Cell. The Terminal Blocks can be mounted anywhere space is available in the Cell.

**STEP 16:** A. Retrofit is now complete.

**STEP 17: TESTING THE BREAKER**

- A. Measure the force necessary to trip the Breaker at the point where the Trip Adjusting Screw Finger impacts the Breaker Trip Plate. The force necessary to trip the Breaker **MUST NOT EXCEED THREE (3) lbs.**
- B. The Retrofit must be tested using primary injection. Refer to Section 8 of the Instructions for the *Application of Digitrip RMS Retrofit Kits on Power Circuit Breakers* (Publication AD 33-855-2), supplied with the Retrofit Kit, for detailed testing procedures and specifications. For test information specific to the Trip Unit, refer to the IL publication supplied with the Retrofit Kit (see the Pick List for the IL number).
- C. While Section 8 of the *Instructions for the Application of Digitrip RMS Retrofit Kits on Power Circuit Breakers* provides the information necessary for testing the Breaker, please keep the following notes in mind when reviewing other sections of the publication.

**CAUTION**

---

**WHEN ALL TESTING IS COMPLETE, THE TRIP UNIT MUST BE RESET. FAILURE TO DO SO MAY CAUSE THE BATTERY IN THE RATING PLUG TO RUN DOWN.**

**NOTES:**

1. *For All Kits Other Than 510 Basic.* If testing the Breaker with Short Delay or Ground Fault functions, be sure to either plug in the Cell Harness Assembly or use the Zone Interlock Shorting Plug. Failure to do so may result in shorter than expected trip times.
2. *For 810 and 910 Kits Only.* Without any power applied to the system (neither the 120 volt power supply nor the Aux. Power Module connected), plug the External Harness into the Cell Harness and check the impedance between COM 1 and COM 2. The impedance should be between one (1) and three (3) ohms. If the impedance is not within this range, trace

the wiring and examine each connection to assure its integrity.

Confirm that the PowerNet communication wiring is correct by following the procedures detailed in Section 7.4 of the Instructions for the Application of Digitrip RMS Retrofit Kits on Power Circuit Breakers. Note that for 810 and 910 Kits, the impedance between COM 1 and COM 2 should be between one (1) and three (3) ohms.

When testing is complete, disconnect the External Harness from the Cell Harness. Final External Harness connection will be performed later in the Retrofit Process.

**DIGITRIP RETROFIT KIT INSTALLATION COMPONENTS  
FOR THE WESTINGHOUSE DK-25 BREAKER**

STEP	DESCRIPTION	STYLE NO.	QTY.	COMMENT
STEP 4	COPPER ADAPTER PARTS	8154A45G17	1	
	COPPER ADAPTER		3	
	COPPER ADAPTER		3	
	.312 - 18 X .875 LNG. HEX BOLT		6	
	.312 - 18 X 1.00 LNG. HEX BOLT		6	
	.312 FLAT WASHER STL.		12	
	.312 LOCK WASHER STL.		12	
STEP 5	SENSOR 600/5 SR	8259A40H01	3	
	SENSOR 400/5 SR	8259A39H01	3	
	SENSOR 200/5 SR	8259A38H01	3	
	SENSOR MOUNTING PARTS	8154A45G04	1	
	SENSOR MOUNTING		1	
	SENSOR MOUNTING		1	
	MOUNTING BRACKET		2	
	.375 - 16 X 3.00 LNG. HEX BOLT		6	
	.375 FLAT WASHER STL.		12	
	.375 LOCK WASHER STL.		6	
	.375 - 16 NUT HEX STL.		6	
	.250 - 20 X .750 LNG. HEX BOLT		4	
	.250 FLAT WASHER STL.		8	
	.250 LOCK WASHER STL.		4	
	.250 - 20 HUT HEX STL.		4	

## DIGITRIP RETROFIT KIT INSTALLATION COMPONENTS FOR THE WESTINGHOUSE DK-25 BREAKER

STEP	DESCRIPTION	STYLE NO.	QTY.	COMMENT
STEP 7	PT MODULE	6502C82G01	1	810/910 KITS ONLY
	PT MODULE INSULATION		1	810/910 KITS ONLY
	.138 - 32 X .500 LNG. SCREW PAN		2	810/910 KITS ONLY
	.138 FLAT WASHER STL.		4	810/910 KITS ONLY
	.138 LOCK WASHER STL.		2	810/910 KITS ONLY
	.138 - 32 NUT HEX STL.		2	810/910 KITS ONLY
	RING TERMINAL .312		3	810/910 KITS ONLY
	WIRE CLIP		5	810/910 KITS ONLY
STEP 8	SENSOR MOUNTING HARDWARE	8154A45G05	1	
	.375 - 16 X 4.00 LNG. SCREW FIL		2	
	.375 FLAT WASHER STL.		2	
	.375 LOCK WASHER STL.		2	
	SENSOR MOUNTING HARDWARE	8154A45G06	1	
	SENSOR MOUNTING ASSEMBLY TOP (FROM STEP 4)		1	
	SENSOR MOUNTING ASSEMBLY BOT. (FROM STEP 4)		1	
	.375 FLAT WASHER STL.		2	
	.375 LOCK WASHER STL.		2	
	.375 - 16 NUT HEX STL.		6	
	.250 - 20 X .750 LNG. HEX BOLT		4	
	.250 FLAT WASHER STL.		4	
	.250 LOCK WASHER STL.		4	
	SENSOR HARNESS PARTS	8154A45G15	1	
	SENSOR HARNESS		1	
	.190 - 32 X .375 LNG. SCREW FIL.		1	
	.190 FLAT WASHER STL.		1	
	.190 LOCK WASHER STL.		1	
WIRE TIES NYLON		8		
STEP 9	DTA	8154A45G03	1	
	DTA UNIVERSAL	6503C67G01	1	
	DTA RESET PARTS	8154A45G08	1	
	DTA MOUNTING PARTS	8154A45G09	1	
	DTA TRIP PARTS	8154A45G10	1	
	DTA RESET ASSEMBLY		1	
	DTA MOUNTING BRACKET		1	
	DTA SUPPORT BRACKET		1	
	DTA PIVOT BRACKET		1	
	DTA TRIP ARM		1	
	PIVOT SHAFT		1	
	X WASHERS		2	
	.250 - 20 FLANGE NUT		1	
	.250 - 20 X .625 LNG. HEX BOLT		2	
	.250 FLAT WASHER STL.		4	
	.250 LOCK WASHER STL.		2	
	.250 - 20 NUT HEX STL.		2	
	.164 - 32 X .500 LNG. SCREW FIL.		2	
	.164 - 32 X .375 LNG. SCREW FIL.		2	

## DIGITRIP RETROFIT KIT INSTALLATION COMPONENTS FOR THE WESTINGHOUSE DK-25 BREAKER

STEP	DESCRIPTION	STYLE NO.	QTY.	COMMENT
STEP 9 (continued)				
	.164 - 32 X .312 LNG. SCREW PAN / LK.		4	
	.164 FLAT WASHER STL.		8	
	.164 LOCK WASHER STL.		4	
	LOCKTITE® 243		1	
STEP 10				
	DTA ASSEMBLY (FROM STEP 9)		1	
	DTA MOUNTING HARDWARE	8154A45G11	1	
	TRIP FINGER PARTS	8154A45G12	1	
	.250 - 20 X .625 LNG. HEX BOLT		2	
	.250 - 14 X .750 LNG. SCREW TC		2	
	.250 FLAT WASHER STL.		6	
	.250 LOCK WASHER STL.		4	
	.250 - 20 NUT HEX STL.		2	
	TRIP FINGER ASSEMBLY		1	
	.164 - 32 X .500 LNG. SCREW FIL.		1	
	.164 FLAT WASHER STL.		1	
	.164 LOCK WASHER STL.		1	
STEP 11				
	AUX. CT MODULE	6503C59G	1	
	AUX. CT MODULE MOUNTING PARTS	8154A45G07	1	
	MOUNTING BRACKET L. H.		1	
	MOUNTING BRACKET R. H.		1	
	.190 - 32 X .375 LNG. SCREW FLAT		4	
	.190 - 32 X .500 LNG. SCREW FIL.		4	
	.190 - 32 X .375 LNG. SCREW FIL.		1	
	.190 FLAT WASHER STL.		17	
	.190 LOCK WASHER STL.		9	
	.190 - 32 NUT HEX STL.		8	
	AUX. CT HARNESS	6502C84G02	1	
	WIRE CLAMPS		2	
	.138 - 32 X .375 LNG. SCREW TC.		2	
	.138 FLAT WASHER STL.		2	
	.138 LOCK WASHER STL.		2	
STEP 12				
	RMS/R TRIP UNIT	1232C84G	1	
	RATING PLUG	3D86709G	1	
	TRIP UNIT ASSEMBLY PARTS	8154A45G13	1	
	MOUNTING BRACKET		2	
	DIGITRIP NAMEPLATE		1	
	.190 - 32 X 4.00 LNG. SCREW FIL.		2	
	.190 FLAT WASHER STL.		4	
	.190 LOCK WASHER STL.		2	
	.190 - 32 NUT HEX STL.		2	
	EXTERNAL HARNESS	6502C83G	1	

## DIGITRIP RETROFIT KIT INSTALLATION COMPONENTS FOR THE WESTINGHOUSE DK-25 BREAKER

STEP	DESCRIPTION	STYLE NO.	QTY.	COMMENT
STEP 13	AUX. SWITCH KIT	8154A45G02	1	810/910 KITS ONLY
	MICROSWITCH		1	810/910 KITS ONLY
	MOUNTING BRACKET		1	810/910 KITS ONLY
	.190 - 32 X .500 LNG. SCREW FIL.		1	810/910 KITS ONLY
	.190 FLAT WASHER STL.		2	810/910 KITS ONLY
	.190 LOCK WASHER STL.		1	810/910 KITS ONLY
	.190 - 32 NUT HEX STL.		1	810/910 KITS ONLY
	.138 - 32 X 1.12 LNG. SCREW PAN		2	810/910 KITS ONLY
	.138 FLAT WASHER STL.		6	810/910 KITS ONLY
	.138 LOCK WASHER STL.		2	810/910 KITS ONLY
	.138 - 32 NUT HEX STL.		2	810/910 KITS ONLY
	STEP 14	EXTERNAL HARNESS PARTS	8154A45G16	1
PT EXTENSION HARNESS		6502C85G01	1	
WIRE TIES NYLON			8	
WIRE CLAMPS			2	
STEP 15	CELL HARNESS	6503C57G	1	

NOTE: DUE TO THE WIDE VINTAGE OF BREAKERS AND MULTIPLE FUNCTIONS OF THE RETROFIT COMPONENTS, SOME EXCESS HARDWARE MAY BE LEFT WHEN THE RETROFIT IS COMPLETE.

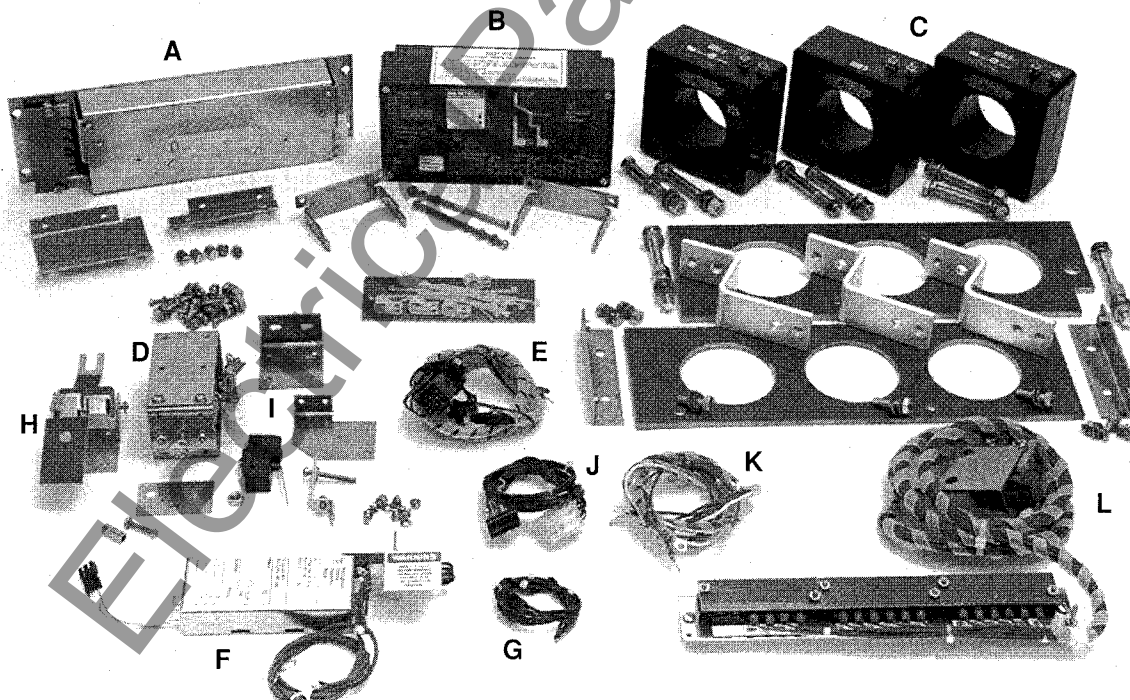

- |                          |                         |                         |
|--------------------------|-------------------------|-------------------------|
| A. Aux. CT Module        | F. PT Module            | I. Aux. Switch          |
| B. RMS/R Trip Unit       | 810/910 Kits Only       | 810/910 Kits Only       |
| C. Sensors               | G. PT Extension Harness | J. CT Extension Harness |
| D. Direct Trip Actuator  | 810/910 Kits Only       | K. Sensor Harness       |
| E. External Wire Harness | H. Reset Assembly       | L. Cell Harness         |

**Table 1 Torque Values for General Mounting and Screw Size Conversion**

<i>Decimal Size (in)</i>	<i>Standard Size</i>	<i>Torque (in-lbs)</i>	<i>Torque (ft-lbs)</i>
.112	4-40	10	0.8
.138	6-32	18	1.5
.164	8-32	36	3.0
.190	10-32	46	3.8
.250	1/4-20	100	8.3
.312	5/16-18	206	17.2
.375	3/8-16	356	29.7
.438	7/16-14	572	47.7
.500	1/2-13	856	71.3

**Table 2 Torque Values for Copper BUS Connectors**

<i>Decimal Size (in)</i>	<i>Standard Size</i>	<i>Torque (in-lbs)</i>	<i>Torque (ft-lbs)</i>
.250	1/4-20	60	5
.312	5/16-18	144	12
.375	3/8-16	240	20
.500	1/2-13	600	50

Notes

www.ElectricalPartManuals.com

We wish to thank you for purchasing the Digitrip Retrofit System. Digitrip Retrofit Kits are designed and manufactured in America with pride. All the components are engineered to fit the existing Circuit Breaker with little or no modifications to the existing Breaker. However due to the wide variety and vintage of Breakers in use today, an occasional problem may arise. Please contact us with any questions, comments or concerns.

Phone: **1-800-937-5487** Fax. (724) 779-5899

*The instructions for installation, testing, maintenance, or repair herein are provided for the use of the product in general commercial applications and may not be appropriate for use in nuclear applications. Additional instructions may be available upon specific request to replace, amend, or supplement these instructions to qualify them for use with the product in safety-related applications in a nuclear facility.*

The information, recommendations, descriptions, and safety notations in this document are based on Cutler-Hammer's experience and judgement with respect to Retrofitting of Power Breakers. This information should not be considered to be all inclusive or covering all contingencies. If further information is required, Cutler-Hammer should be consulted.

**NO WARRANTIES, EXPRESSED OR IMPLIED, INCLUDING WARRANTIES OF FITNESS FOR A PARTICULAR PURPOSE OR MERCHANTABILITY, OR WARRANTIES ARISING FROM COURSE OF DEALING OR USAGE OF TRADE, ARE MADE REGARDING THE INFORMATION, RECOMMENDATIONS AND DESCRIPTIONS CONTAINED HEREIN.** In no event will Cutler-Hammer be responsible to the user in contract, in tort (including negligence), strict liability or otherwise, for any special, indirect, incidental, or consequential damage or loss whatsoever, including but not limited to damage to or loss of use of equipment, plant or power system, cost of capital, loss of profits or revenues, cost of replacement power, additional expenses in the use of existing power facilities, or claims against the user by its customers resulting from the use of the information, recommendations, and descriptions contained herein.

**Cutler-Hammer**

Pittsburgh, Pennsylvania U.S.A.

Publication No. I.B. 33-861-5A  
January 2001  
Printed in U.S.A./TBG00015

**EATON**