

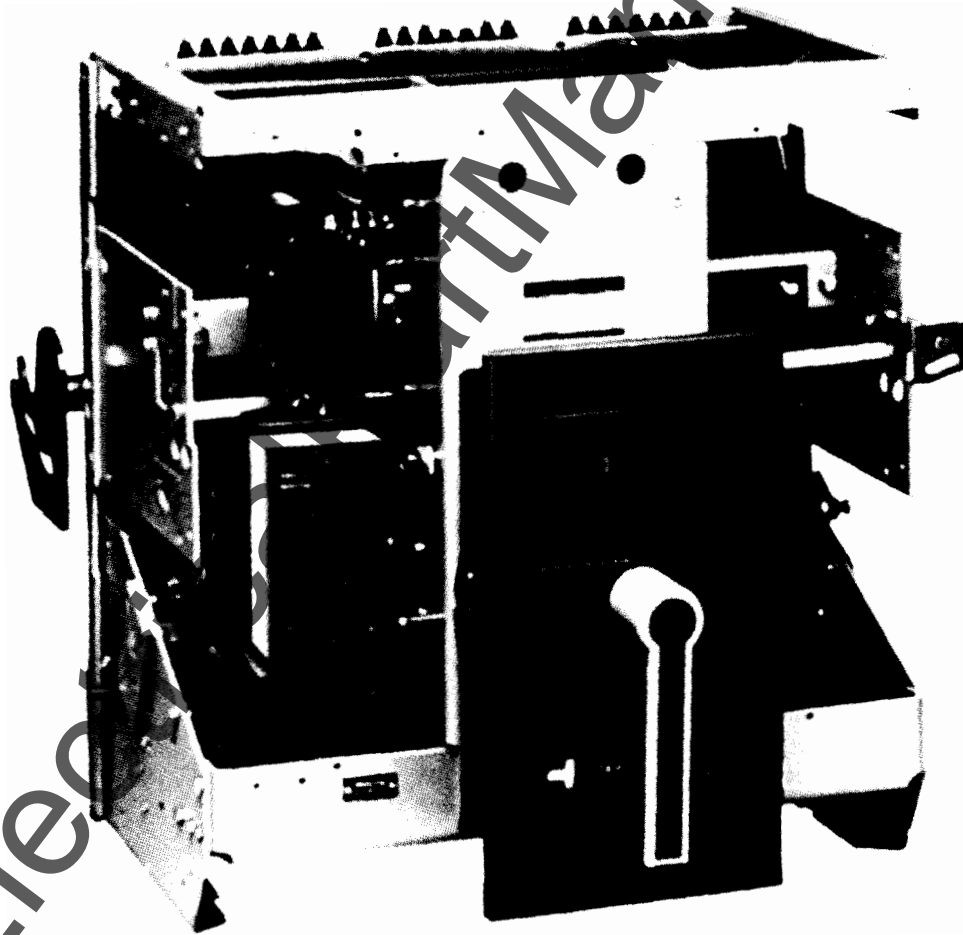

Low Voltage Power Circuit Breakers

Type AKR-75 and AKR-100



INTRODUCTION

This manual provides a listing of the parts and assemblies that are available as replacement parts for low voltage circuit breakers, types AKR-75 and AKR-100.

Parts and assemblies included in this list are from the basic breaker. To order parts and assemblies for breaker accessories, refer to summary list or the breaker nameplate data.

Renewal parts which are furnished may not be identical to the original parts since, from time to time, design changes may be made. The parts supplied, however, will be interchangeable with the original parts.

INDEX OF RENEWAL PARTS COVERED BY THIS PUBLICATION

Figure No.	Quantity Required For 3-Pole Breaker		Catalogue Number		Description
	AKR-75	AKR-100	AKR-75	AKR-100	
1	1	1	See Table A		Bell Alarm Assembly
2	3	3	425D288G1	425D288G2	Upper Stud & Terminal Assembly
3	3	3	139C4470G1	139C4470G2	Lower Stud
4	1	1	See Table B		Shunt Trip Device
5	1	1	See Table C		Closing Solenoid
6	1	1	See Table D		Charging Motor, with driving pawl
7	1	1	See Table E		Closing Relay "X"
8	1	1	See Table E		Closing Relay "K"
9	1	1	See Table E		Anti-Pump Relay "Y"
10	1	1	425D385G1	425D384G1	MicroVersaTrip® Flux Shifter- 25" Wide
10	---	1	----	425D385G2	MicroVersaTrip® Flux Shifter-33" Wide
11	1	1	See Table F		Current Transformer
12	1	1	139C4458G1	139C4458G1	Cut-Off Switch Assembly
13	1	1	425D291G31	425D291G32	Back Frame Assm., Complete--25" Wide
13	---	1	----	425D291G33	Back Frame Assm., Complete--33" Wide
14, 14A	1	1	425D289G13	425D289G14	Electric Front Frame, Complete-25" Wide
14, 14A	---	1	----	425D289G15	Electric Front Frame, Complete-33" Wide
15, 15A	1	1	425D287G1	425D287G3	Manual Front Frame, Complete-25" Wide
15, 15A	---	1	----	425D287G2	Manual Front Frame, Complete-33" wide
16	1	1	242B7020G3	242B7020G4	Arc Chute*
17, 17A	1	1	See Table G		Static Timing Device
18	1	1	See Table H		Auxiliary Switch, SB-12
19	1	1	See Table I		Electroswitch
20	1	1	See Table J		Draw-Out Racking Mechanism
21	**	**	386A110G2	386A110G2	Secondary Disconnect Terminal Block (7pt.)
22	1	1	568B383P1	568B384P1	Primary Disconnect - Tube Type
23	2	2	568B450G1	568B450G2	Primary Disconnect - Finger Type
24	2	2	139C4549G3	139C4549G4	Upper Connectors and Fingers
24	1	1	569B622P3	569B622P4	Heat Sinks, Inner (All Phases)
24	2	2	569B622P1	569B622P2	Heat Sinks, Outer (Phase B Only)
25	1	1	121C2870G3	121C2870G4	Open Fuse Lock-out Device, Complete
26, 26A	1	1	TAK83FCB	TAK94FCB	Fuse Roll-out Element
27	1	1	***	***	MicroVersaTrip® RMS-9 Programmer
28	1	1	***	***	Epic MicroVersaTrip™ Programmer
29	1	1	192A7153P3	192A7153P3	Switchette (used in D.C. control only)
30	---	---	See Table K		Contacts and Spring
31	1	1	See Table L		Undervoltage Device
32	1	1	192A9717G3	192A9717G3	Push Button Closing Switch (will include insulator, mtg hardware, and label)
33	1	1	286A8096G2	286A8096G2	Closing Handle (Manual Breaker)
34	1	1	See Table M		Escutcheon

* As of January, 1989, the AKR 75/100 breaker design incorporates asbestos-free arc chute. Older models of these breakers will require an Asbestos-Free Replacement Kit: Drawing #0202B7020.

** Quantity is determined by control scheme.

*** Refer to side sticker on programmer unit for replacement information.

TABLE 1

FRAME SIZE (Amperes)		BREAKER DESIGNATION	MOUNTING TYPE					DEEP ESCUTCHEON	PRIMARY STUD TYPE	BREAKER WIDTH (Inches)	
250V. Dc	600V. Ac 50/60 Hz.		DRAWOUT				Sub- Structure				Stationary
			AKD	AKD-5	AKD-6	AKD-8					
4000	3000	AKR-(*)-75						X	Bar	25	
			X						Tube		
		AKR-(*)A-75		X	X				Tube		
	3200	AKR-(*)B-75					X		X		Fingers
		AKR-(*)C-75			X						Fingers
		AKR-(*)D-75				X			X		Fingers
		AKR-(*)F-75					X		X		Fingers
	AKR-(*)S-75						X	Bar			
6000	4000	AKR-(*)-100	X						Tube	33	
		AKR-(*)A-100		X	X				Tube		
		AKR-(*)B-100					X		X	Fingers	
		AKR-(*)C-100			X					Fingers	25
		AKR-(*)D-100				X			X	Fingers	
		AKR-(*)F-100					X		X	Fingers	
			AKR-(*)S-100						X	Bar	
	AKR-(*)W-100						X	Bar	33		
SPECIAL DC BREAKERS FOR FIELD SWITCHING											
4000	AKR-N-75F	X							Tube	25	
	AKR-NB-75F					X		X	Fingers		
	AKR-ND-75F				X			X	Fingers		
	AKR-NF-75F					X		X	Fingers		
	AKR-NS-75F						X		Bar		
6000	AKR-N-100F	X							Tube	33	
	AKR-NB-100F					X		X	Fingers		
	AKR-ND-100F				X			X	Fingers		
	AKR-NF-100F					X		X	Fingers		
	AKR-NS-100F						X		Bar	25	
	AKR-NW-100F						X		Bar		

Example: AKR-5B-75 identifies a drawout, substructure-mounted breaker equipped with the SST trip device. The EC trip devices are electro-mechanical, refer to GEI 86157 for detailed information.

BREAKER MODELS

(*) This digit identifies the trip device:
 2 = EC-1 or EC-2A. Dc only
 4 = ECS
 5 = SST 50/60 Hertz only.
 6 = Micro Versa Trip 50/60 Hertz only.
 For detailed information on these trip devices refer to the following publication: GEI-86157

N = Non-automatic.
 In addition, all non-automatic 250V Dc breaker types carry the suffix letter D after the frame number, e.g., AKR-NB-75D

NOTE: AKR breakers equipped with SST programmers have not been offered since 1981. SST replacement programmers, phase/neutral current sensors, wiring harnesses, and associated renewal parts have been discontinued. Future requirements must be handled by converting AKR breakers to MicroVersaTrip® RMS-9 using the latest conversion kits described in Publication GEA-10678B.

AKR-75 and AKR-100, 2 pole DC Breakers are no longer available from the factory.

ORDERING INSTRUCTIONS

1. Furnish the complete nameplate data of the breaker.
2. Specify quantity, cat. no., item no. and description for each part, and state this bulletin no.
3. Standard hardware items (zinc dichromate-coated screws, grade 5 bolts, nuts, washers, etc.) are not listed in this bulletin. These items, or equivalent, should be obtained locally.
4. For pricing, proper installation and maintenance instructions, contact your local GE ED&C sales and/or service representative

Figure 1.
Bell Alarm Assembly

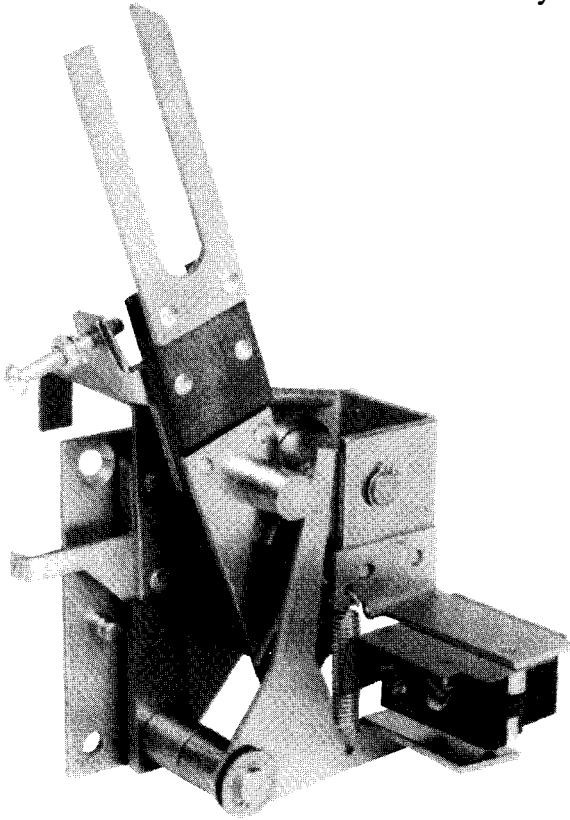

Table A. Bell Alarm (less mounting)

Catalog No. 425D304G-	Type
-G1	No Lockout - 1NO + 1 NC
-G2	No Lockout - 2NC
-G3	No Lockout - 2NC
-G4	W/Lockout - 1 NO + 1 NC
-G5	W/Lockout - 2NO
-G6	W/Lockout - 2NC

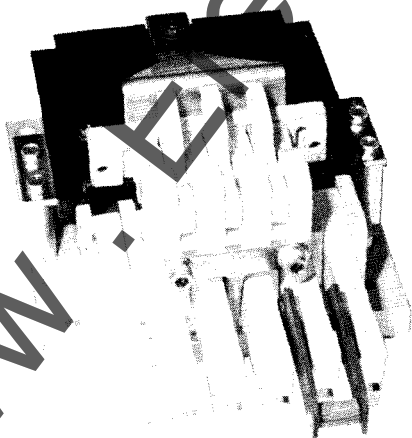

Figure 2. Upper Stud and Terminal Assembly

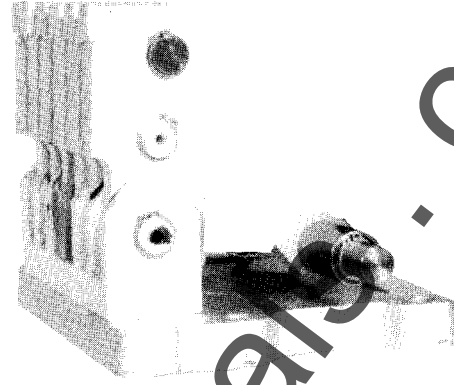

Figure 3. Lower Stud

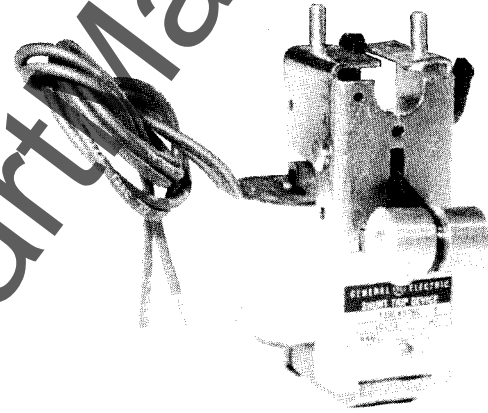

Figure 4. Shunt Trip Device

Table B. Shunt Trip Device

Volts	Hertz	Complete Cat. No.	Shunt Trip Cat. No.	Coil Only Cat. No.
24	DC	139C4454G1	139C4378G1	6275081G55
32	DC	G2	G2	G25
48	DC	G3	G3	G28
125	DC	G4	G4	G29
250	DC	G5	G5	G30
70	60	G6	G6	G62
120	60	G7	G7	G25
120	50	G8	G8	G56
208	60	G10	G10	G26
208	50	G11	G11	G26
240	60	G13	G13	G26
240	50	G14	G14	G26
240	40	G15	G15	G26
380	50	G17	G17	G27
480	60	G18	G18	G27
480	50	G19	G19	G4
575	60	G21	G21	G7
575	50	G22	G22	G29

Figure 5. Closing Solenoid

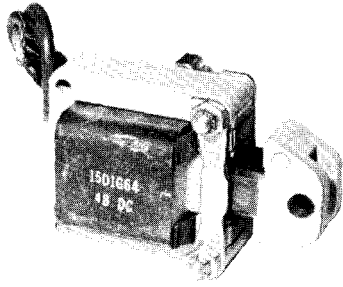

Table C. Closing Solenoid

Volts	Hertz	Closing Solenoid Cat. No. 192A9794P-
48	DC	-P11
125	DC	-P12
250	DC	-P13
120	60	-P14
120	50	-P15
208	60	-P21
208	50	-P23
240	60	-P16
240	50	-P17

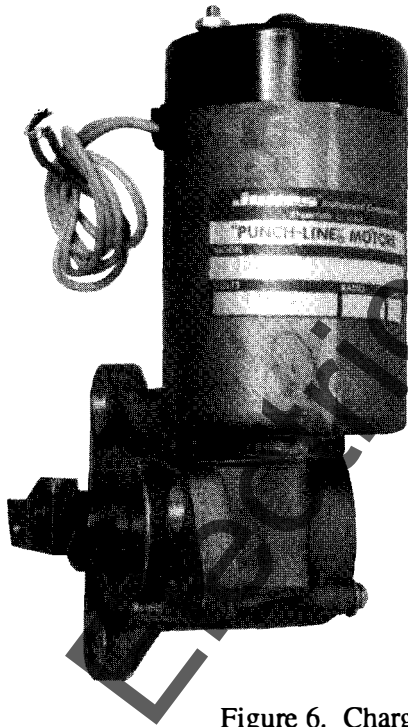

Figure 6. Charging Motor

Table D. Charging Motor (complete w/driving pawl)

Voltage	Cat. No. 568B596G-
48V DC	-G4
125V DC	-G5
250V DC	-G6
120V AC	-G5
208V AC	-G6
240V AC	-G6

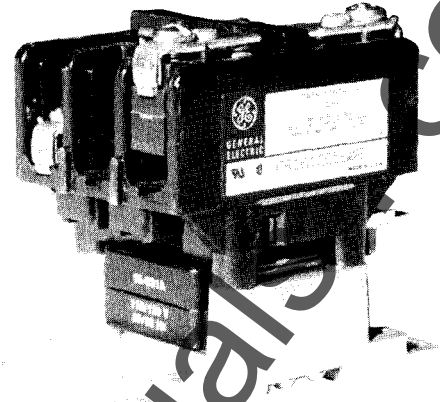

Figure 7. Closing Relay "X"

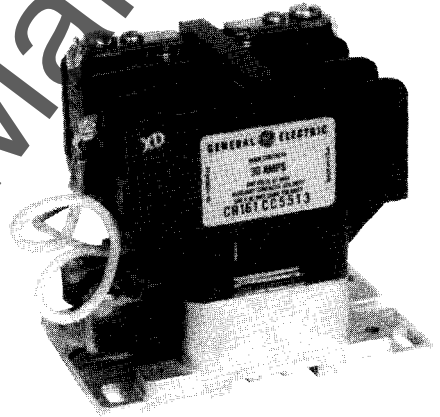

Figure 8. Closing Relay "K"



Figure 9. Anti-Pump Relay "W"

Table E. Relays

VOLTAGE	"X" Relay Cat. No. 192A9770P-	"W" (Anti-Pump) Relay Cat. No. 192A9771P-	"K" Relay Cat. No. 192A9770P-
48V DC	-P1	-P1	-P13
125V DC	-P2	-P2	-P14
250V DC	-P3	-P3	---
120V60 HZ	-P4	-P4	-P15
120V50 HZ	-P5	-P4	-P15
208V60 HZ	-P6	-P5	-P16
208V50 HZ	-P7	-P5	-P16
240V60 HZ	-P8	-P6	-P16
240V50 HZ	-P9	-P6	-P16

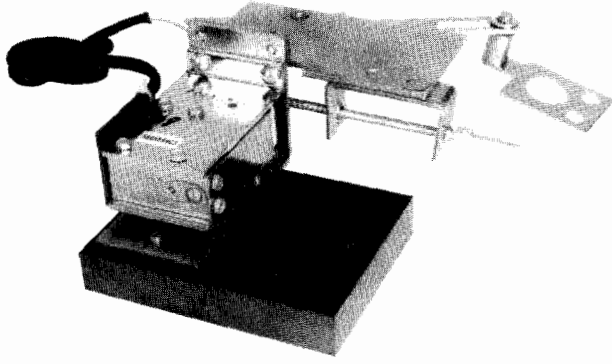

Figure 10. MicroVersaTrip® Flux Shifter

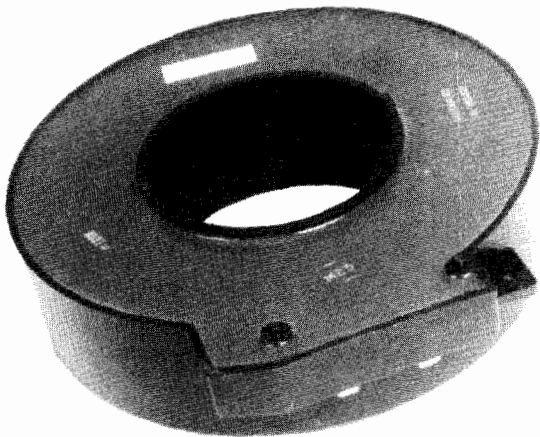

Figure 11. Current Transformer

Table F. Current Transformer

Amp Rating	AKR - 75		AKR - 100	
	Catalog No.	Rating Plug	Catalog No.	Rating Plug
1200	139C4970G38	TR32S1200	---	---
1600	139C4970G38	TR32S1600	139C4970G39	TR40S1600
2000	---	---	139C4970G39	TR40S2000
2400	139C4970G38	TR32S2400	---	---
2500	---	---	139C4970G39	TR40S2500
3000	---	---	139C4970G39	TR40S3000
3200	139C4970G38	TR32S3200	---	---
4000	---	---	139C4970G39	TR40S4000

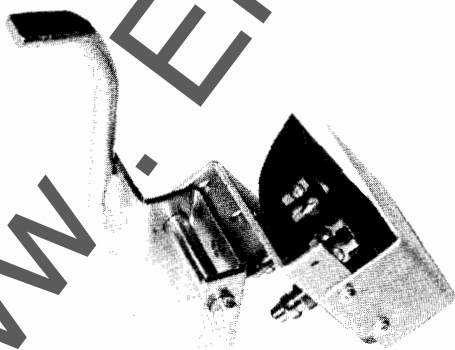

Figure 12. Cut-Off Switch Assembly

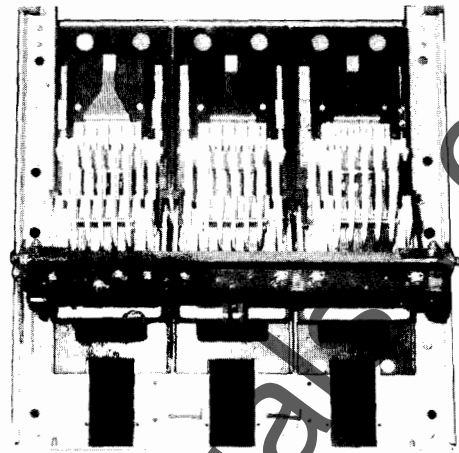

Figure 13. Back Frame Assembly

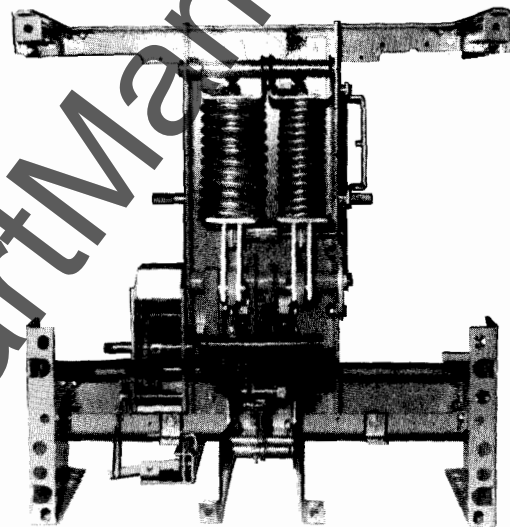

Figure 14. Electric Front Frame (back view)

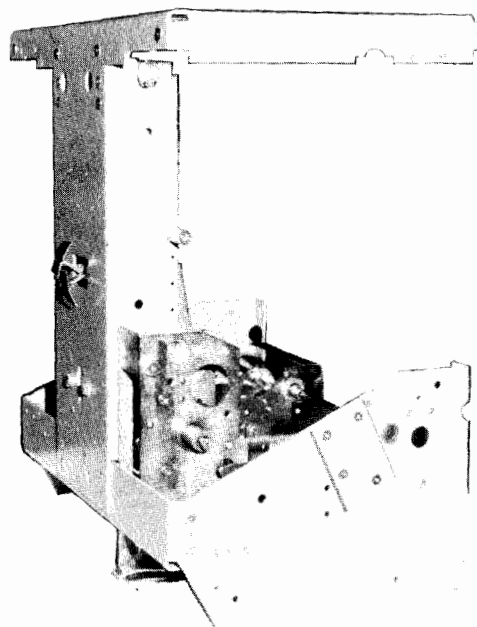

Figure 14A. Electric Front Frame (side view)

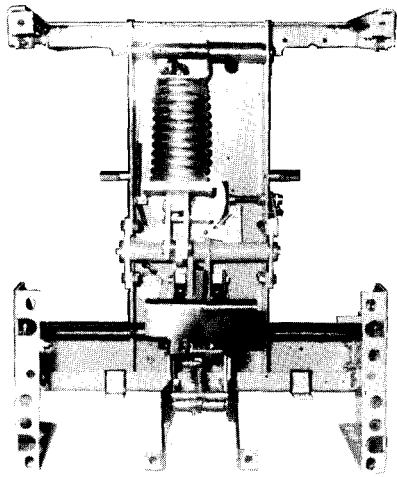

Figure 15. Manual Front Frame (back view)

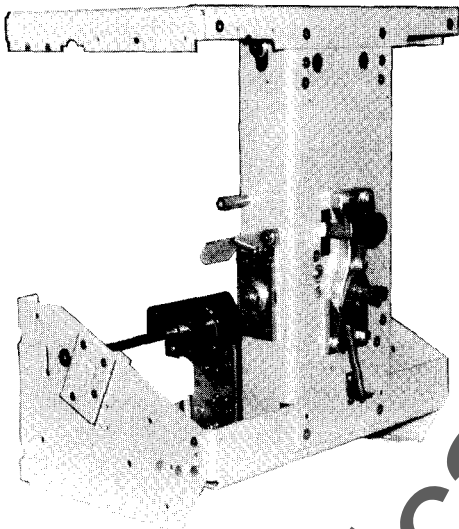

Figure 15A. Manual Front Frame (side view)

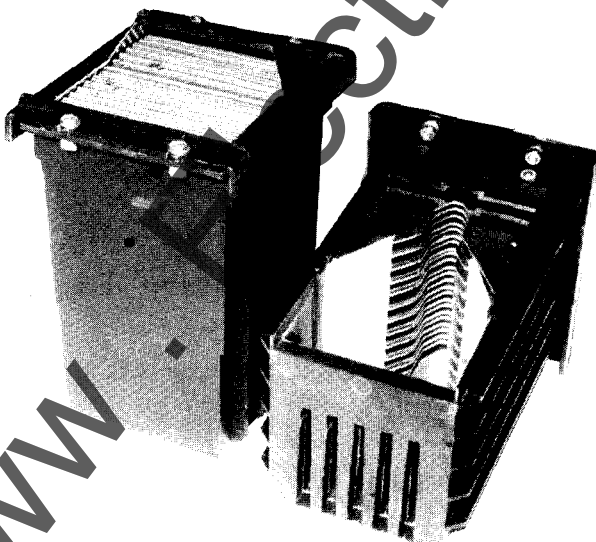

Figure 16. Arc Chute (Asbestos-free shown)

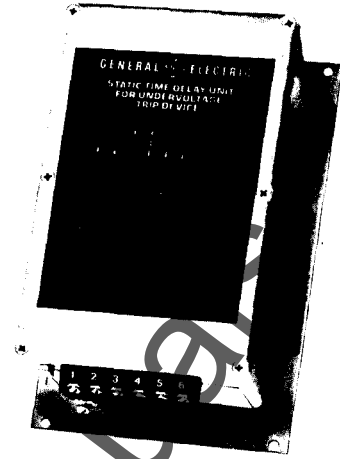

Figure 17. Static Timing Device

Table G. Static Timing Device

Voltage	Catalog Number
230V Hz	TAKYUVT - 3
125V DC	TAKYUVT - 1
250V DC	TAKYUVT - 2

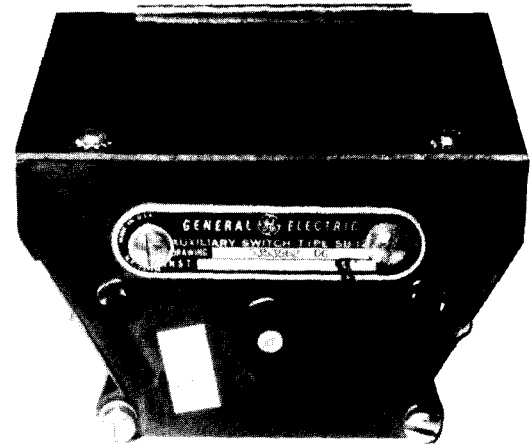

Figure 18. Auxiliary Switch

Table H. Auxiliary Switch SB-12

Stages	Electrical Cat. No. 139C4526G-	Manual Cat. No. 139C4526G-
2	-G1	-G13
3	-G2	-G14
5	-G3	-G15
6	-G4	-G16

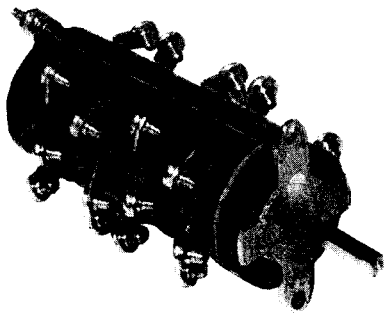

Figure 19. Electroswitch Auxiliary Switch

Table I. Electroswitch Auxiliary Switch

Cat. No.	Stages	Contact Arrangement					
242B7016P2	2	ab	ab				
242E7016P3	3	ab	ab	ab			
242B7016P5	5	ab	ab	ab	ab	ab	
242B7016P6	6	ab	ab	ab	ab	ab	ab

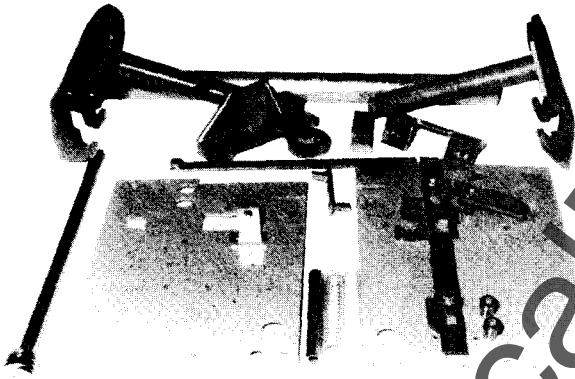

Figure 20. Draw-Out Racking Mechanism

Table J. Racking Mechanism

	AKR - 75		AKR - 100	
	Manual	Electrical	Manual	Electrical
AKD Equip. Substructure	425D293G5	425D293G2	425D293G6	425D293G3
	425D293G4	425D293G1	425D293G4	425D293G1

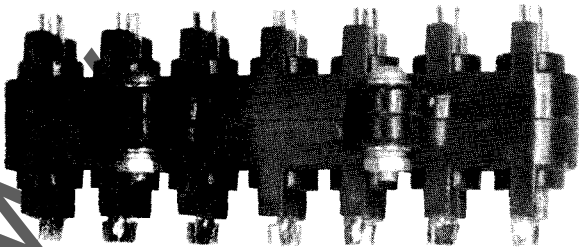

Figure 21. Secondary Disconnect Terminal Block

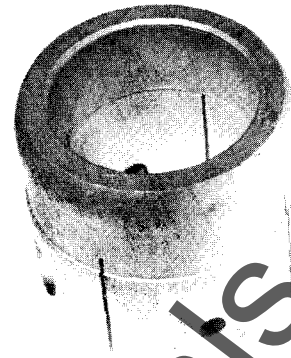

Figure 22. Primary Disconnect (tube-type)

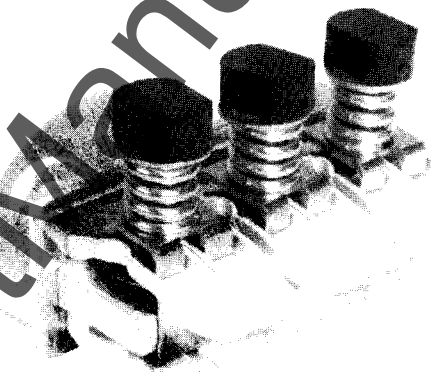
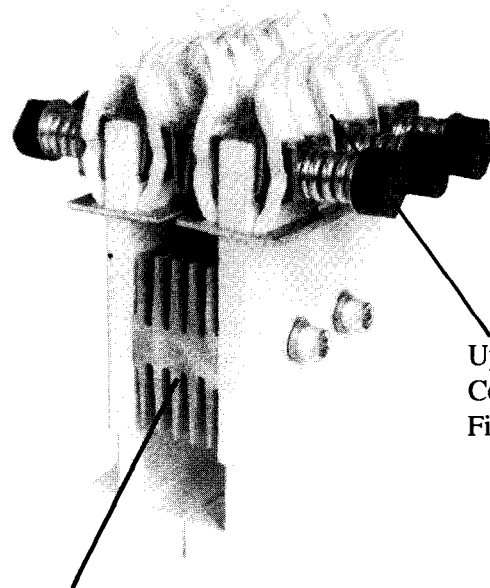

Figure 23. Primary Disconnect (finger-type)



Heat Sink, Inner
(Outer not shown)

Upper
Connector &
Fingers

Figure 24. Upper Connector, Fingers, & Heat Sinks

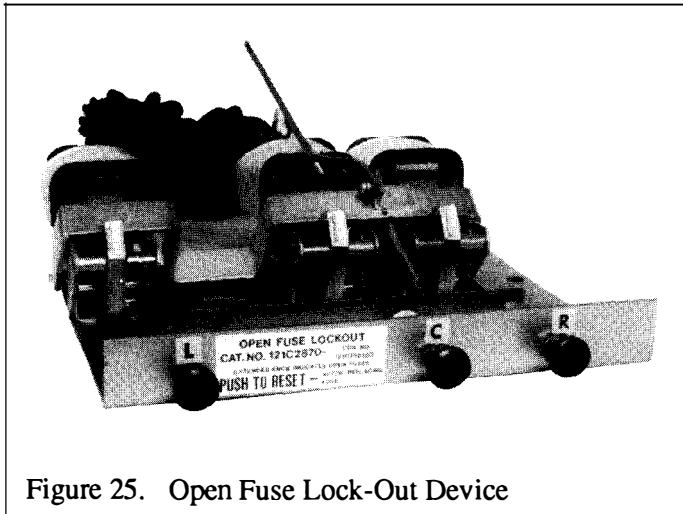

Figure 25. Open Fuse Lock-Out Device

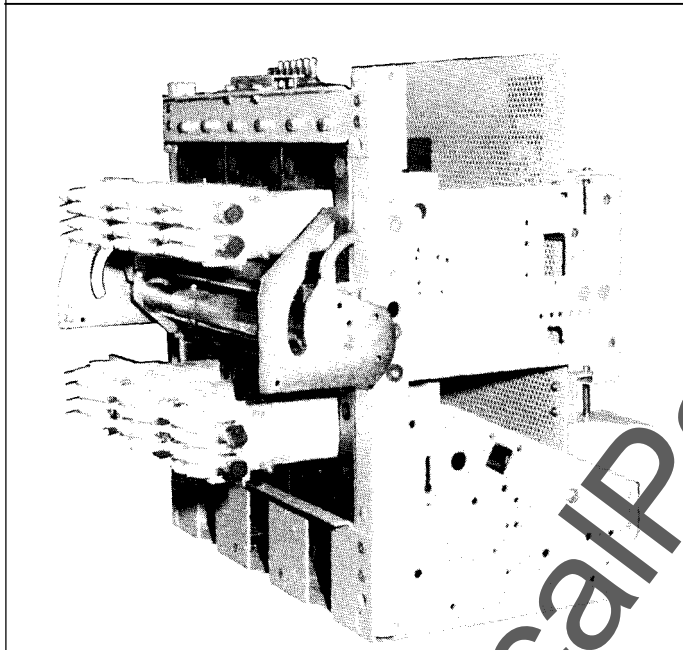

Figure 26. Fuse Roll-Out Element (side & back view)

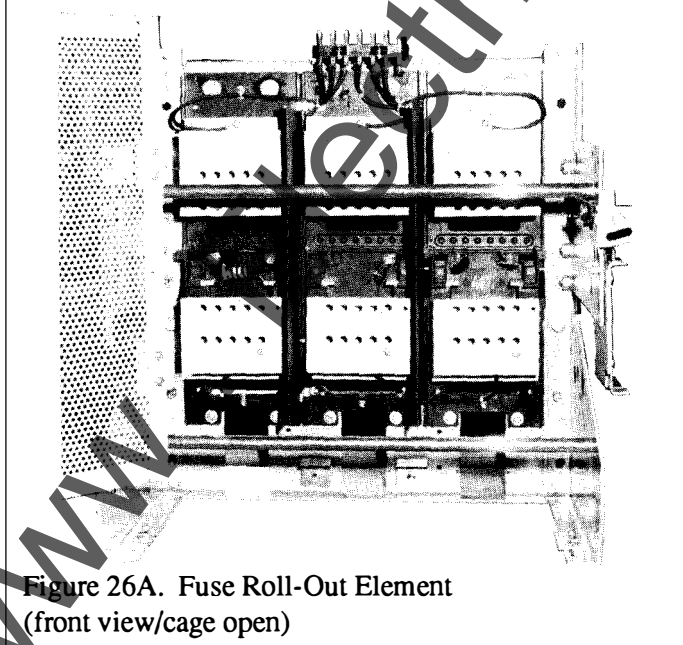

Figure 26A. Fuse Roll-Out Element (front view/cage open)

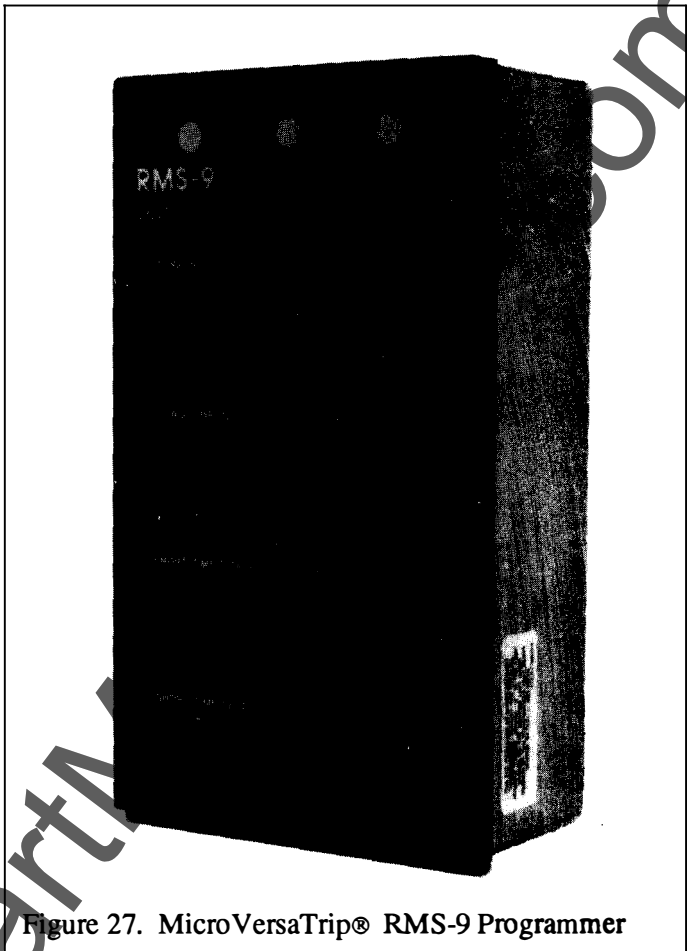

Figure 27. MicroVersaTrip® RMS-9 Programmer

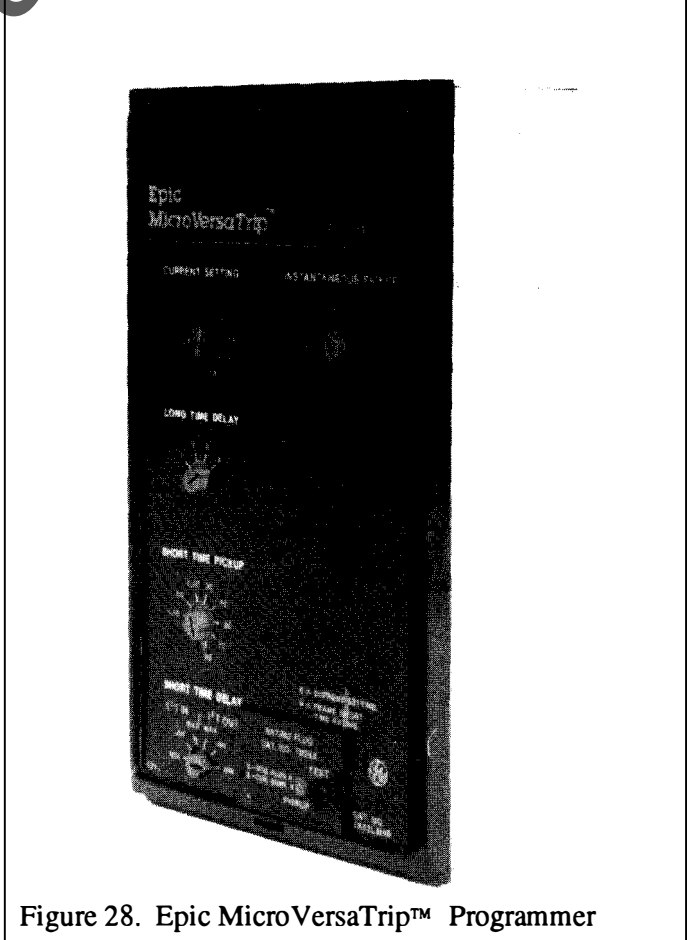

Figure 28. Epic MicroVersaTrip™ Programmer

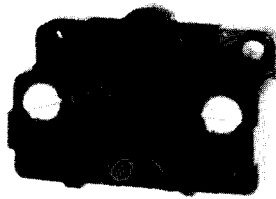

Figure 29. Switchette

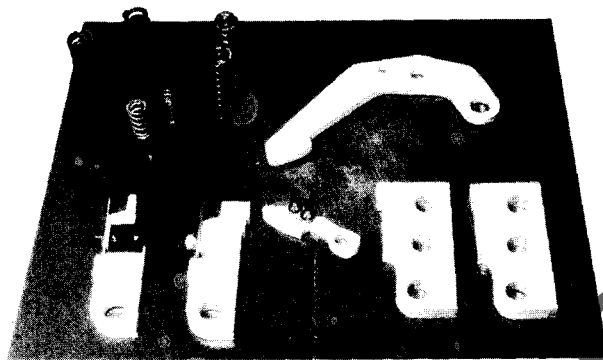

Figure 30. Contacts & Springs

Table K. Contacts and Springs

Qty Req. Per 3-Pole Brkr		Catalog Number		Description
AKR 75	AKR 100	ARK 75	AKR 100	
9	15	9921572G3	9921572G3	Moving Arcing Contact
3	3	193A1126G7	193A1126G7	Moving Interm. Contact
	3	-----	193A1126G9	Moving Interm. Contact (L)
9	9	193A1126G10	193A1126G10	Moving Main Contact (L)
6	9	193A1126G8	193A1126G8	Moving Main Contact (R)
9	15	295B408G3	295B408G3	Stationary Arcing Contact
3	3	193A1127G1	193A1127G1	Stat. Interm. Contact (R)
	3	-----	193A1127G2	Stat. Interm. Contact (L)
6	9	193A1125G1	193A1125G1	Stat. Main Contact (R)
9	9	193A1125G2	193A1125G2	Stat. Main Contact (L)
9	15	6509858P1	6509858P1	Spring (Stat. Arcing Contact-Outer)
9	15	6509859P1	6509859P1	Spring (Stat. Arcing Contact-Inner)
18	24	412A288P1	412A288P1	Spring (Stat. Interm. Main Contact)

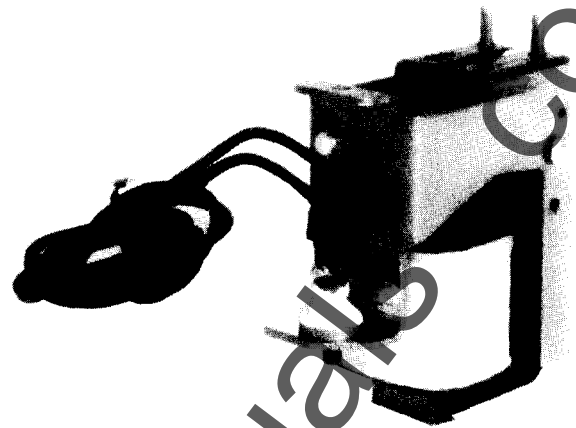

Figure 31. Undervoltage Device

Table L. Undervoltage Device

		Instantaneous Undervoltage Device		Time-Delay Undervoltage Device	
		Complete W/Coil (less mtg) Cat. No. 568B309G-	Coil Only Cat. No. 6275081G-	Complete, W/Coil, (less mtg) Cat. No. 568B309G-	Coil Only Cat. No. 6275081G-
24	DC	-G1	-G15		
48	DC	-G2	-G9		
125	DC	-G3	-G18	-G5	-G61
250	DC	-G4	-G19	-G6	-G59
120	60	-G7	-G26		
120	50	-G8	-G4		
120	25	-G9	-G12		
208	60	-G10	-G27		
208	50	-G11	-G12		
208	25	-G12	-G10		
230	50	-	-	-G24	-G59
230	60	-	-	-G24	-G59
240	60	-G13	-G7		
240	50	-G14	-G12		
240	40	-G15	-G9		
240	25	-G16	-G10		
380	50	-G17	-G31		
480	60	-G18	-G31		
480	50	-G19	-G3		
480	25	-G20	-G17		
575	60	-G21	-G20		
575	50	-G22	-G8		
575	25	-G23	-G21		

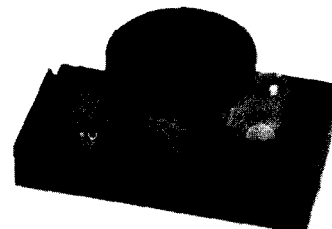

Figure 32. Push Button Closing Switch

www.ElectricalPartManuals.com



GE Electrical Distribution & Control