

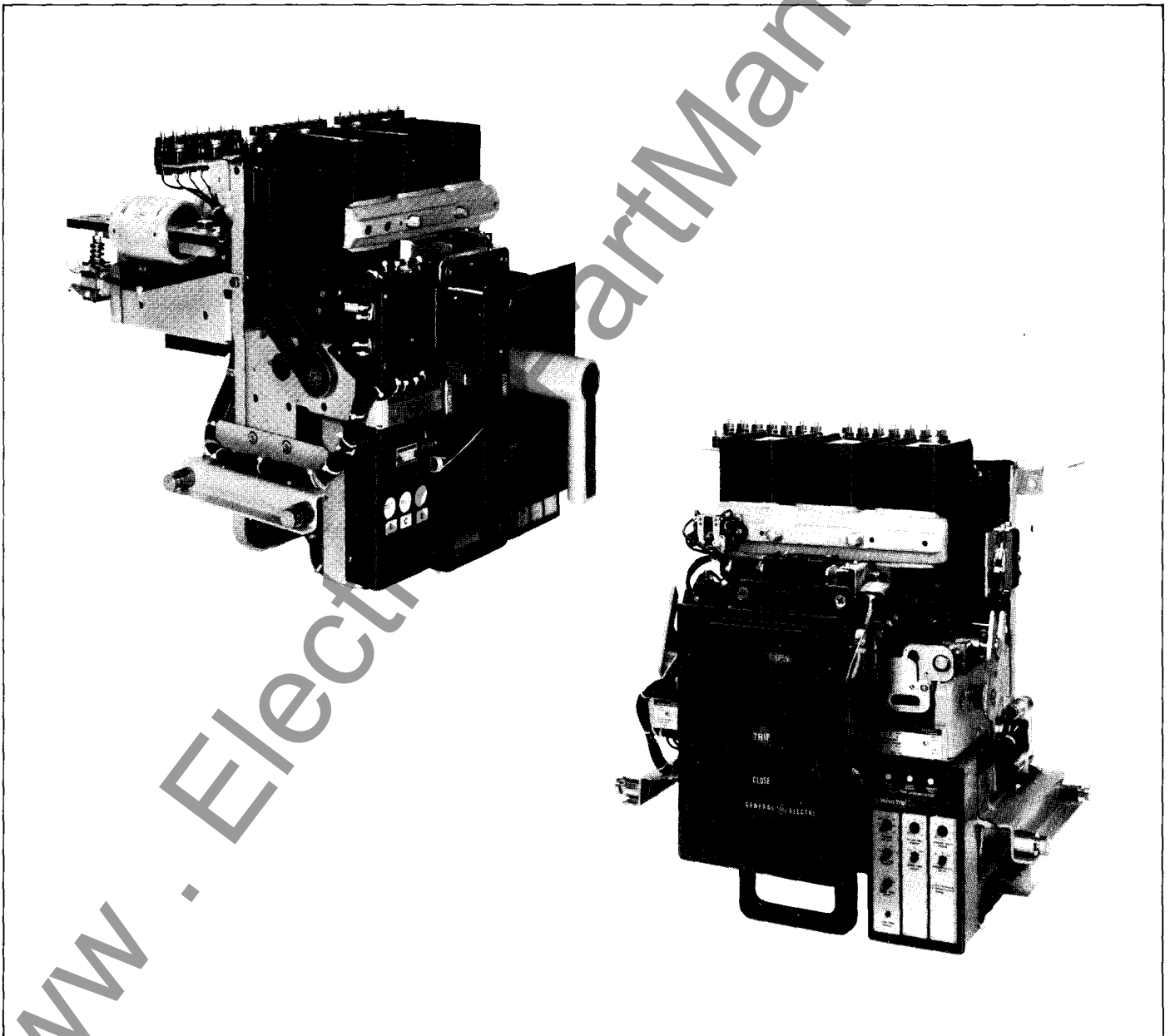

Low Voltage Power Circuit Breakers

Type AKR-30S and AKRU-30S



INTRODUCTION

This manual provides a listing of the parts and assemblies that are available as replacement parts for low voltage circuit breakers, types AKR-30S and AKRU-30S.

Parts and assemblies included in this list are from the basic breaker. To order parts and assemblies for breaker accessories, refer to summary list or the breaker nameplate data.

When ordering renewal parts, specify catalog number and the quantity required. Complete nameplate data of breaker involved should be given, as well as an accurate description and part number of each part required. Direct your order to your local GE ED & C sales office.

Renewal parts which are furnished may not be identical to the original parts since, from time to time, design changes may be made. The parts supplied, however, will be interchangeable with the original parts.

INDEX OF RENEWAL PARTS COVERED BY THIS PUBLICATION

Fig. No.	Quantity Required For 3-Pole Breaker		Catalog Number	Description
	AKR-30S	AKRU-30S		
1	3	3	286A8843P1	Connector
2	1	1	**	MicroVersaTrip® RMS-9 Programmer
3	1	1	**	Epic MicroVersaTrip™ Programmer
4	—	1	108C9667G2	Open Fuse Lock-out (OFLO Device)
5	1	1	567B686G8	MicroVersaTrip® Flux Shifter
6	3	3	See Table A	Current Transformer
7	3	3	269C257G15	Movable Contact Arm Assembly
8	3	3	569B582G1	Upper Stud Assembly
8	6	6	286A8858G1, G2, G3	Stationary Contacts (Requires all 3 groups per phase)
8	6	6	192A6990P387	Spring
9	3	3	293B288G2	Arc Chute
10	1	3	184L700BFG22	Back Frame (complete)
11	1	1	See Table B	Undervoltage Device
12	1	1	See Table C	Relays
13	3*	3*	386A110G2	Secondary Disconnect Terminal Block
14	1	1	See Table D	SB-12 Auxiliary Switch
15	1	1	See Table E	Electroswitch Auxiliary Switch
16	6	6	192A9668G15	Primary Disconnect
17	1	1	See Table F	Shunt Trip
18	1	1	269C277G1	Crossbar
19	3	3	286A8711G1	Lower Stud
20	1	1	622C505G1	Cut-off Switch Assembly
21	1	1	See Table G	Closing Solenoid Coil
22	1	1	622C529G1	Closing Push Button
23	1	1	184L700FMG23	Front Frame (Electric)
24	1	1	184L700FMG22	Front Frame (Manual)
25	1	1	184L700DOG37	Draw-out, Racking and Interlocks only (Drawing reference 425D445P1)

* Maximum quantity

** Refer to side sticker on programmer unit for replacement information.

ORDERING INSTRUCTIONS

1. Furnish the complete nameplate data of the breaker.
2. Specify quantity, cat. no., item no. and description for each part, and state this bulletin no.
3. Standard hardware items (zinc dichromate-coated screws, grade 5 bolts, nuts, washers, etc.) are not listed in this bulletin. These items, or equivalent, should be obtained locally.
4. For pricing, contact your local GE ED & C sales office.

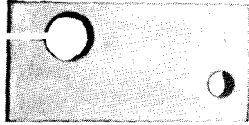

Figure 1. Connector

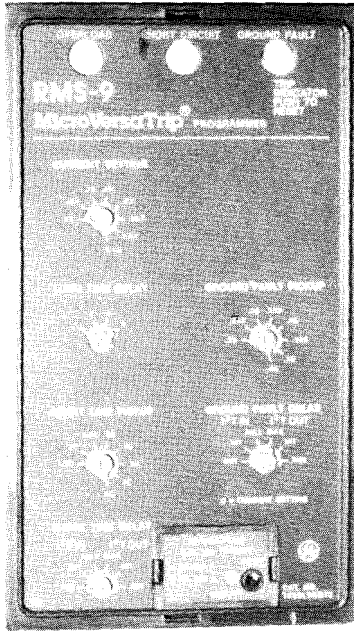

Figure 2. Micro VersaTrip® RMS-9 Programmer

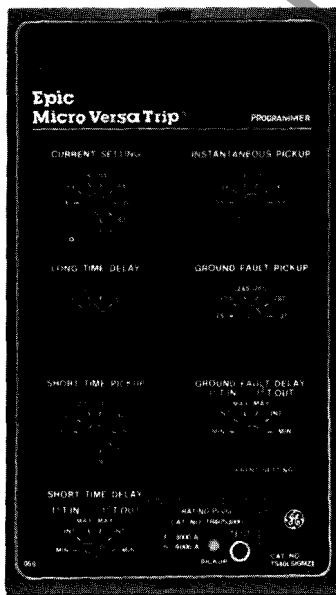

Figure 3. Epic Micro VersaTrip™ Programmer



Figure 4. Open Fuse Lock-out

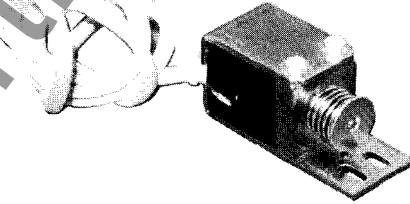

Figure 5. MicroVersaTrip® Flux Shifter

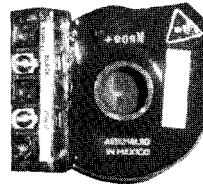

Figure 6. Current Transformer

Table A. Current Transformers and Rating Plugs

Amp Range	Current Transformer	Rating Plug
150	139C4970G206 139C4970G218 ("H" Option)	TR1S60
		TR1S80
		TR1S100
		TR1S125
		TR1S150
400	139C4970G209 139C4970G221 ("H" Option)	TR4S150
		TR4S200
		TR4S225
		TR4S250
		TR4S300
800	139C4970G211 139C4970G223	TR8S300
		TR8S400
		TR8S500
		TR8S600
		TR8S700

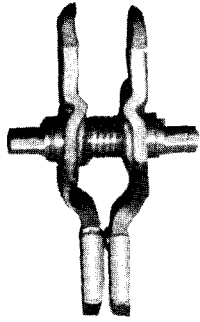

Figure 7.
Movable Contact
Arm Assembly

Figure 8.
Upper
Stud Assembly

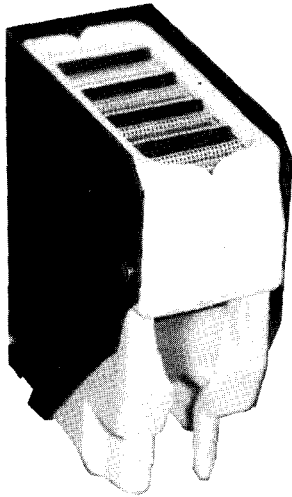
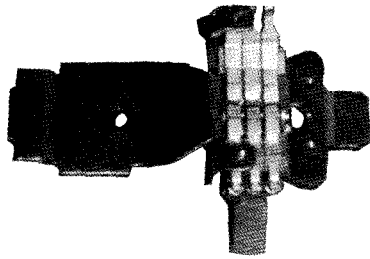

Figure 9.
Arc Chute

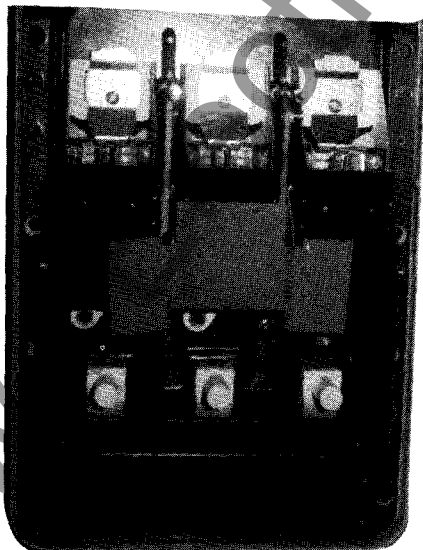

Figure 10. Back Frame (Complete)

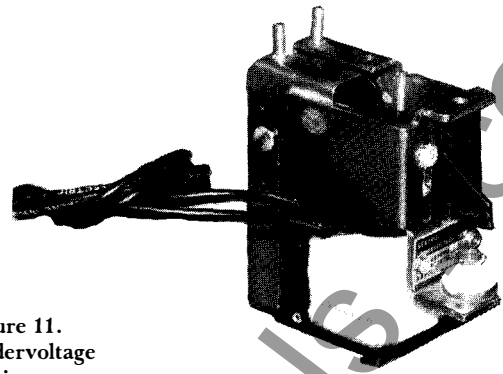
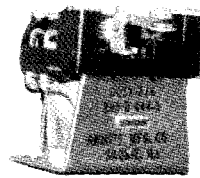

Figure 11.
Undervoltage
Device

Table B. Undervoltage Device

Volts	Hertz	Instantaneous Undervoltage Device		Time Delay Undervoltage Device	
		Complete with Coil (Less Mounting)	Coil Only	Complete with Coil (Less Mounting)	Coil Only
		Cat. 568B309 -	Cat. K6275081	Cat. 568B309 -	Cat. K6275081 -
24	DC	G 1	G15	—	—
48	DC	2	9	—	—
125	DC	3	18	G 5	G61
250	DC	4	19	6	59
120	60	7	26	—	—
120	50	8	4	—	—
208	60	10	27	24	59
208	50	11	12	24	59
240	60	13	7	24	59
240	50	14	12	24	59
380	50	17	31	—	—
480	60	18	31	—	—
480	50	19	3	—	—
575	60	21	20	—	—
575	50	22	8	—	—



“W” or “E” Relay

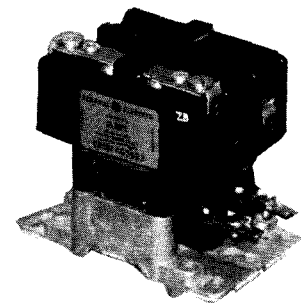

“K” or “X” Relay

Figure 12. Relays

Table C. Relays

Voltage	“K” or “X” Relay	“W” or “E” Relay
48V DC	192A9770 P1	192A9771 P1
125V DC	192A9770 P2	192A9771 P2
250V DC	192A9770 P3	192A9771 P3
120V 60HZ	192A9770 P4	192A9771 P4
120V 50HZ	192A9770 P5	192A9771 P4
208V 60HZ	192A9770 P6	192A9771 P5
208V 50HZ	192A9770 P7	192A9771 P5
240V 60HZ	192A9770 P8	192A9771 P6
240V 50HZ	192A9770 P9	192A9771 P6

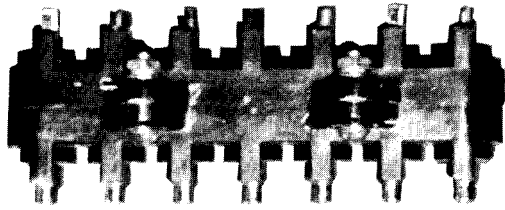

Figure 13. Secondary Disconnect Terminal Block

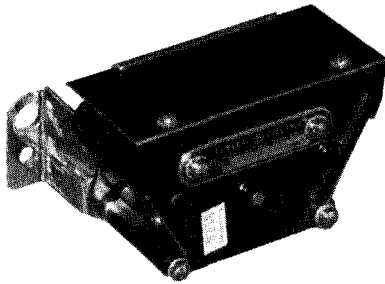

Figure 14. SB-12 Auxiliary Switch

Table D. SB-12 Auxiliary Switch

Cat. No. 192A9791P-	Stages	Contact Arrangement				
		ab	ab	—	—	—
P 17	2	ab	ab	—	—	—
20	5	ab	ab	ab	ab	ab
21	5	ab	ab	aa	aa	aa
22	5	ab	ab	ab	aa	aa
23	5	ab	ab	ab	ab	bb
24	2	aa	ab	—	—	—
25	5	ab	ab	ab	bb	bb
26	5	ab	ab	ab	ab	aa

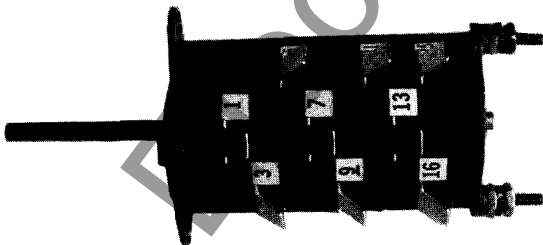

Figure 15. Electroswitch Auxiliary Switch

Table E. Electroswitch Auxiliary Switch

Cat. No.	Stages	Contact Arrangement				
		ab	ab	—	—	—
242B7016P17	2	ab	ab	—	—	—
242B7016P20	5	ab	ab	ab	ab	ab

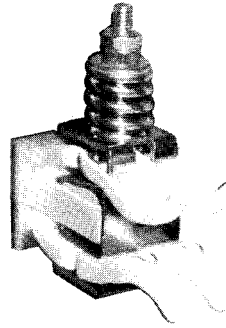

Figure 16.
Primary Disconnect

Figure 17.
Shunt Trip

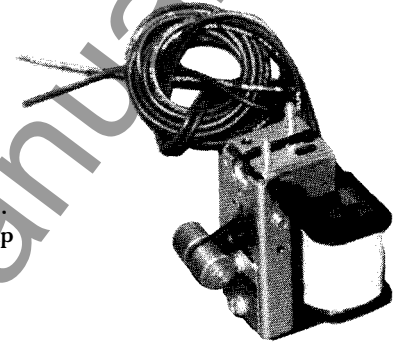

Table F. Shunt Trip Device

Volts	Hertz	Complete with Coil (Less Mounting)	Coil Only
		Cat. 139C4378 -	Cat. K6275081 -
24	DC	G1	G55
48	DC	3	28
125	DC	4	29
250	DC	5	30
70	60	6	62
120	60	7	25
120	50	8	56
208	60	10	26
208	50	11	26
240	60	13	26
240	50	14	26
380	50	17	27
480	60	18	27
480	50	19	4
575	60	21	7
575	50	22	29

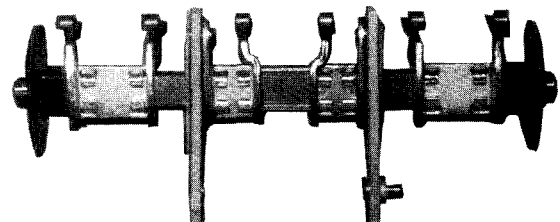

Figure 18. Crossbar



Figure 19.
Lower Stud

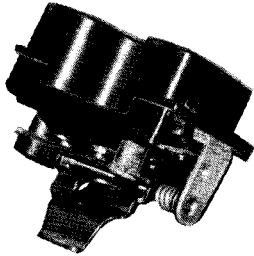

Figure 20. Cut-off Switch Assembly

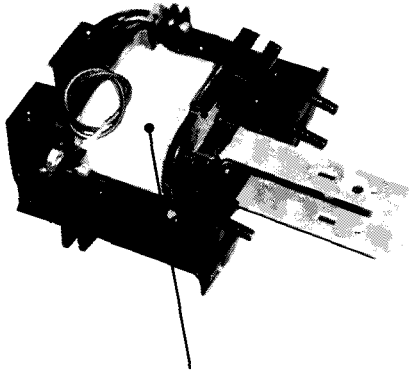

Figure 21. Closing Solenoid Coil

Table G. Closing Solenoid Coil

Voltage	Closing Solenoid Coil
48V DC	366A773G17
125V DC	366A773G13
250V DC	366A773G15
120V 60HZ	366A773G1
120V 50HZ	366A773G2
208V 60HZ	366A773G3
208V 50HZ	366A773G3
240V 60HZ	366A773G4
240V 50HZ	366A773G5

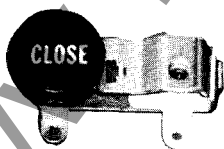

Figure 22.
Closing Push Button

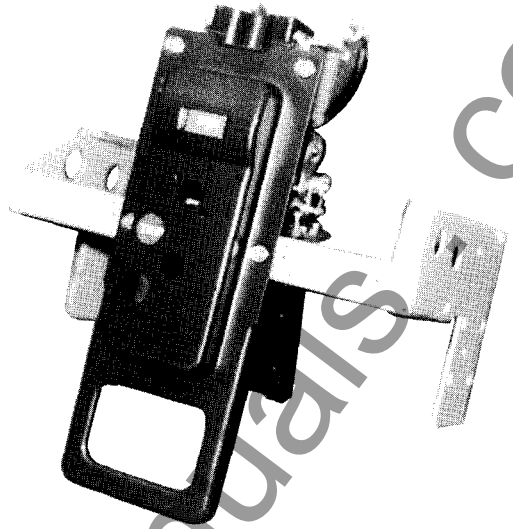

Figure 23. Front Frame (Electric)

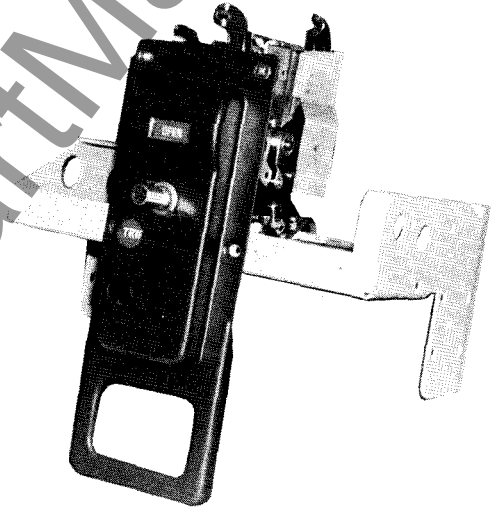

Figure 24. Front Frame (Manual)

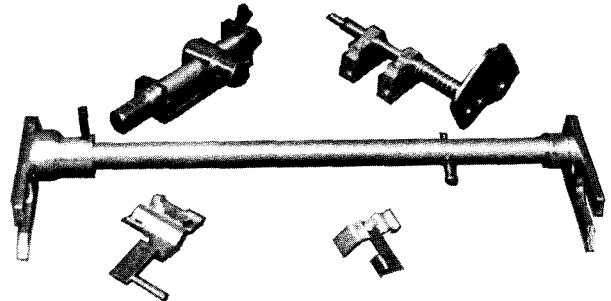

Figure 25. Draw-out (Racking and Interlocks Only)

www.ElectricalPartManuals.com

www.ElectricalPartManuals.com



GE Electrical Distribution & Control

General Electric Company
41 Woodford Ave., Plainville, CT 06062

©1989 General Electric Company

GEF-6005 0690 BLE