

For Additional Technical Assistance Call +1.509.332.1890

# Express Installation Guide

## SEL-751A Feeder Protection Relay



## Package Contents

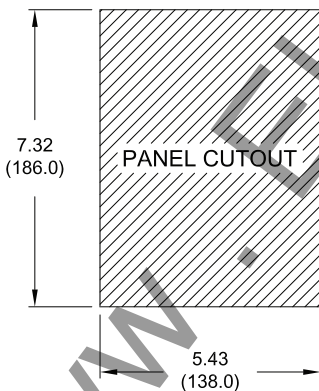

Panel Cutout Template



Manual CD & ACSELERATOR<sup>®</sup> QuickSet<sup>™</sup> Software CD



No. 8-32 Mounting Screws, Gasket, & Serial Port Cover

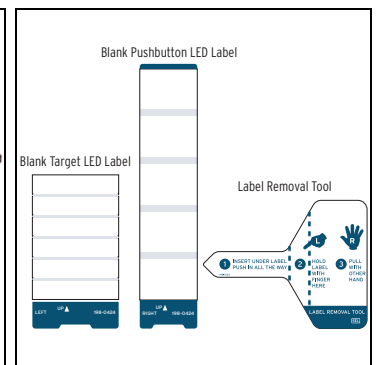

Configurable Label Kit (if equipped)

# Typical Connections

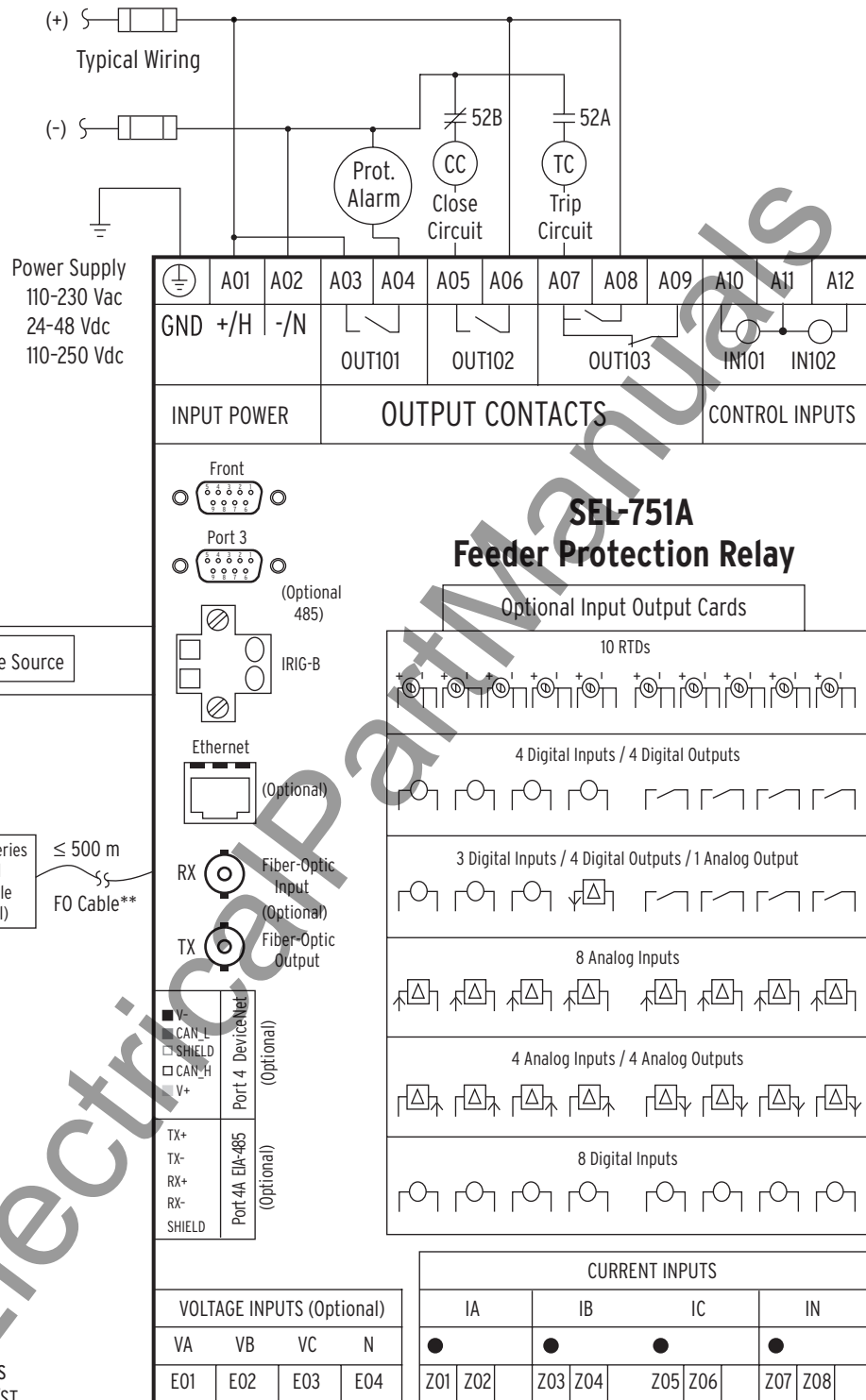

\*\* SEL Fiber Optic Cables  
240-1506 – 1 m (3.3 ft) ST/ST  
240-1507 – 5 m (16.4 ft) ST/ST  
240-1508 – 15 m (49.2 ft) ST/ST  
Other lengths available by request

A diagram for a four-wire wye connection is also available in the instruction manual.

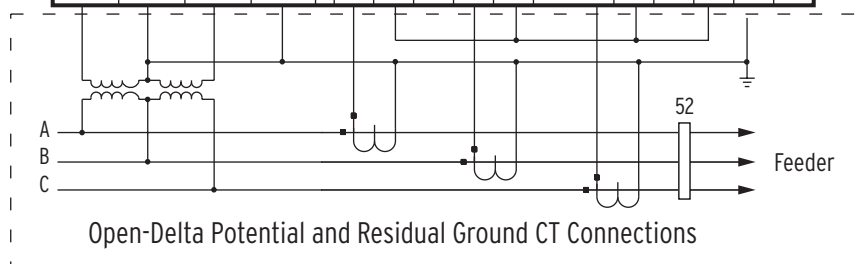

# Rack Mounting

You should mount the SEL-751A in a sheltered indoor environment (a building or an enclosed cabinet) that does not exceed the temperature rating of  $-40^{\circ}\text{C}$  to  $+85^{\circ}\text{C}$ . For mounting consideration, the relay dimensions are shown below.

## New Control Center

- Step 1. Place the enclosed Panel Cutout over desired mounting location and trace.
- Step 2. Make smooth cut around cutout.
- Step 3. Place mounting gasket around relay and insert unit into hole. Use SEL-751A appearance bezel if cut is not as accurate as desired. (Photo in *Step 3* displays optional appearance bezel.)
- Step 4. Fasten relay to mounting plate with included screws.

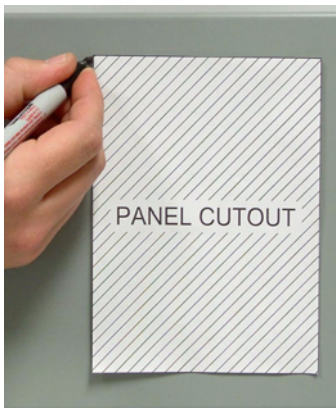
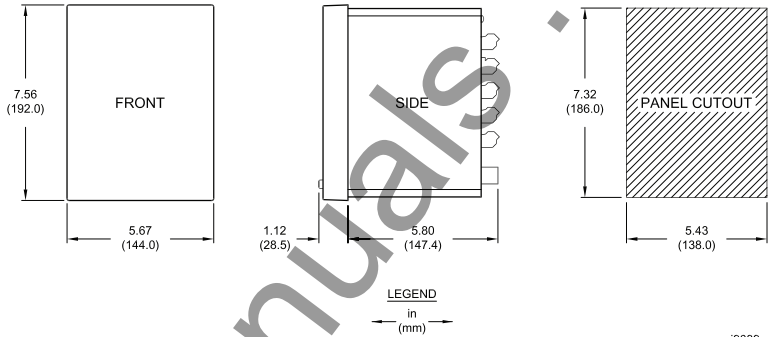

Step 1

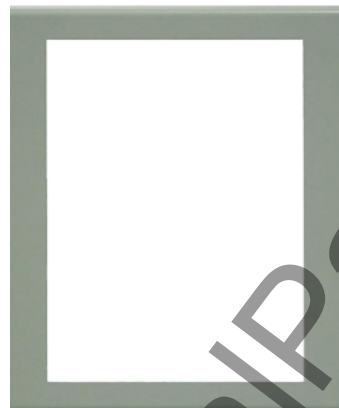

Step 2



Step 3



Step 4

## Retrofitting

- Step 1. Remove old relay.
- Step 2. Insert retrofitting plate and fasten (several retrofit plates are available—see <http://www.selinc.com/sel-751a.htm>).
- Step 3. Place mounting gasket around relay and insert unit into retrofitting plate.
- Step 4. Fasten relay to mounting plate with included screws.

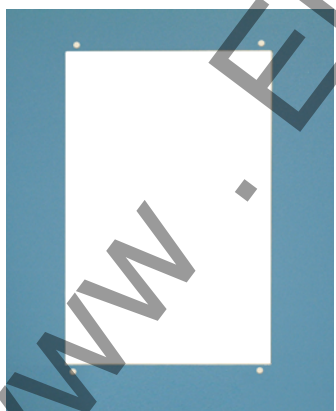

Step 1



Step 2



Step 3

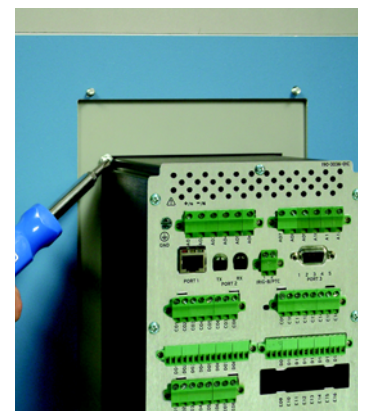

Step 4

# Connections

Shown for the SEL-751A with Ethernet, Fiber Optic, IRIG-B, EIA-232, 4 DO/3 DI/1 AO Option, 8 DI Option, and Voltage Option. Refer to the SEL-751A manual for additional details and other options.

Wire sizes for connections are dictated by the terminal blocks and expected load currents. You may use the following table as a guide in selecting wire sizes:

Connection Type	Minimum Wire Size	Maximum Wire Size
Grounding (Earthing) Connection	18 AWG (0.8 mm <sup>2</sup> )	14 AWG (2.5 mm <sup>2</sup> )
Current Connection	16 AWG (1.5 mm <sup>2</sup> )	12 AWG (4 mm <sup>2</sup> )
Potential (Voltage) Connection	18 AWG (0.8 mm <sup>2</sup> )	14 AWG (2.5 mm <sup>2</sup> )
Contact I/O	18 AWG (0.8 mm <sup>2</sup> )	14 AWG (2.5 mm <sup>2</sup> )
Other Connection	18 AWG (0.8 mm <sup>2</sup> )	14 AWG (2.5 mm <sup>2</sup> )

## Card Slot A: Power Supply Card With 2 DI/3 DO

- Step 1. Connect ground terminal GND to a rack frame or switchgear ground for proper safety and performance.
- Step 2. Connect appropriate power supply to terminal 01 (+/H) and terminal 02 (-/N). Note that power terminals are isolated from chassis ground.
- Step 3. Connect up to 2 digital inputs, per application requirements, to optoisolated inputs IN101 (terminals 10, 11) and IN102 (terminals 11, 12).
- Step 4. Connect the 3 output contacts, per application requirements, to OUT101 (terminals 03, 04), OUT102 (terminals 05, 06), and OUT103 (terminals 07, 08, 09).

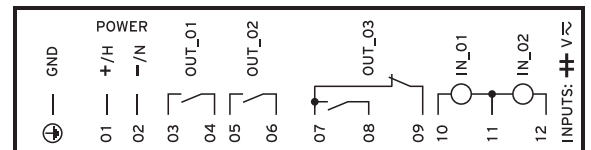
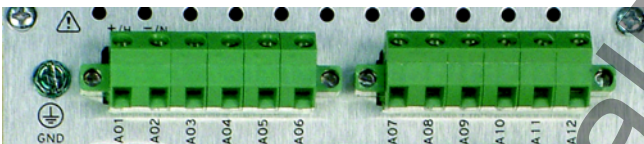

## Card Slot B: Main Board With Ethernet, Fiber Optic, IRIG-B, and EIA-232

- Step 1. Connect communications devices as required to front DB-9 serial Port F (EIA-232), rear Port 3 (EIA-232), 10/100BASE-T Ethernet (RJ-45 connector) Port 1 and fiber-optic (ST<sup>®</sup> connector) serial Port 2.
- Step 2. Connect IRIG-B time-code input to terminals 01 (+) and 02 (-).

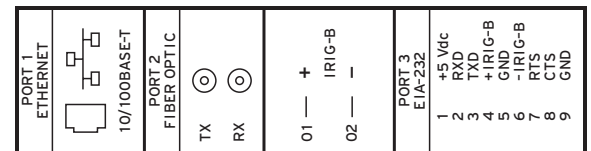
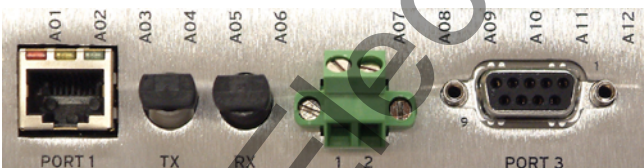

## Card Slot C: 3 Digital Inputs, 4 Digital Outputs, 1 Analog Output Card (3 DI/4 DO/1 AO)

- Step 1. Connect additional digital inputs (IN\_01, IN\_02, IN\_03) and outputs (OUT\_01, OUT\_02, OUT\_03, OUT\_04), if required by application, using the connection diagram.
- Step 2. Connect the analog (transducer) output AO\_01 using terminals 09 and 10.

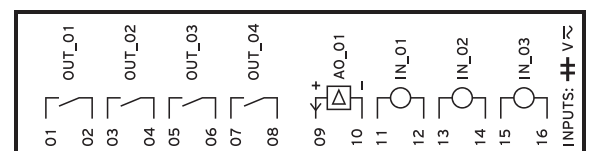
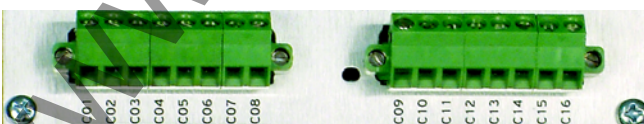

### Card Slot D: 8 Digital Inputs Card (8 DI)

Connect up to 8 digital inputs per application requirements to inputs IN\_01 (terminals 01 and 02), IN\_02 (terminals 03 and 04), . . . , IN\_08 (terminals 15 and 16).

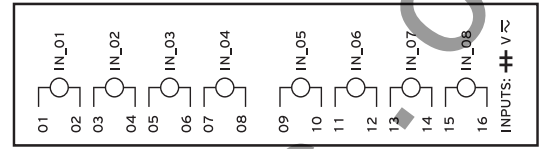
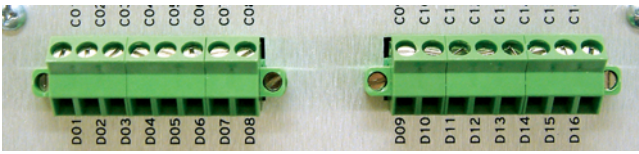

### Card Slot E: Voltage Inputs Card

Connect 4-wire wye-connected PTs or open-delta connected PTs as shown in the typical connections diagram. For other PT connection options refer to Section 2 of the SEL-751A manual.

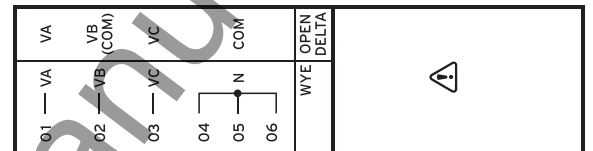
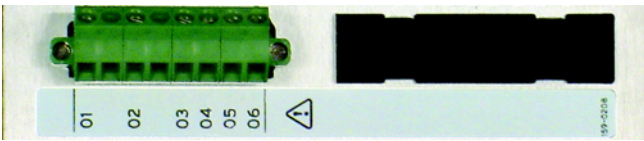

### Card Slot Z: Current Inputs Card

Connect phase current and neutral current inputs as shown in the typical connections diagram.

Step 1. Connect Phase A, Phase B, Phase C current inputs to terminals 01, 02; terminals 03, 04; and terminals 05, 06, respectively, following the convention shown in the typical connections diagram.

Step 2. Connect neutral current IN inputs to terminals 07, 08.

Refer to Section 2 of the SEL-751A manual for additional details and other connection options.

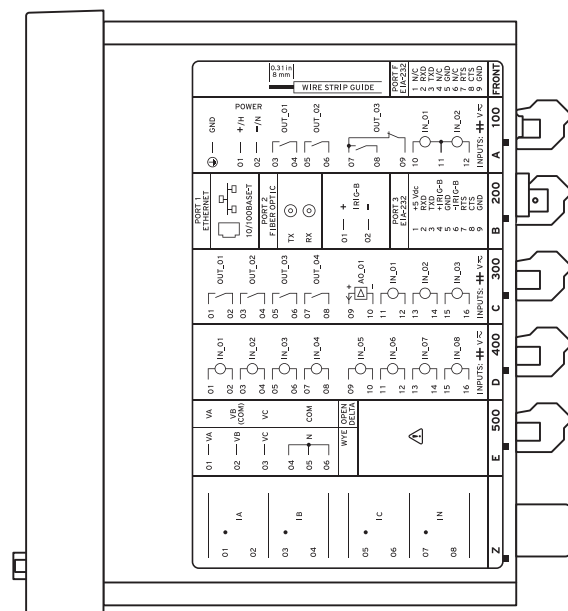
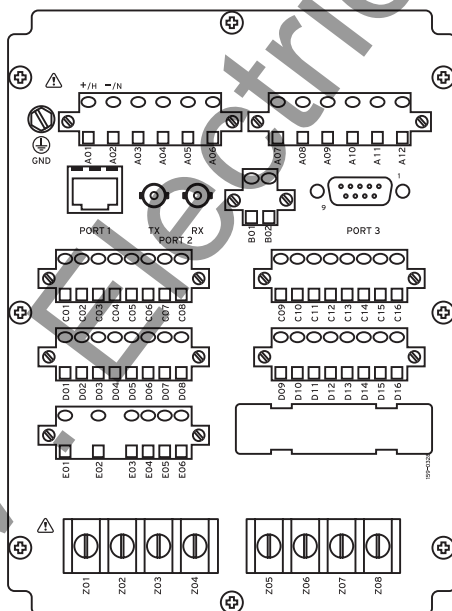
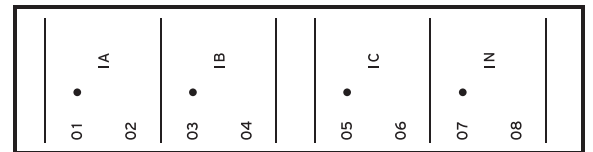
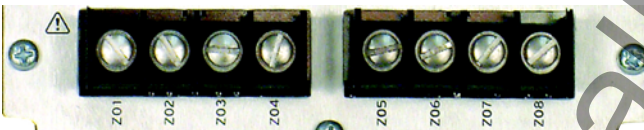

# Relay Application: Arc Flash Protection



## Reduce Arc Flash Hazards

This section of the Express Installation Guide provides step-by-step instructions for a possible application of the SEL-751A Feeder Protection Relay. For more information on the setting procedures, please refer to the SEL-751A instruction manual, or contact your local SEL representative. For more information on relay setting using a PC configuration, please refer to Section 3 of the SEL-751A instruction manual.

The SEL-751A can be used to enable and disable Arc Flash Hazard Energy (AFHE) reducing protection. The AFHE reducing protection enables a phase overcurrent element that is set sensitive enough to provide instantaneous tripping for phase fault on downstream energized equipment. When properly implemented, this protection may, reduce incident energy exposure.

The SEL-751A relay is equipped with four levels of phase instantaneous overcurrent elements (50P1, 50P2, etc.) that may be set and temporarily activated with a front panel pushbutton, to provide enhanced (faster and/or more sensitive) protection while energized work is being done on downstream equipment. It should be noted that activating this protection scheme might result in loss of device coordination.

This example will use setting 50P1P for the AFHE protection.

- Step 1. Connect to the SEL-751A Feeder Protection Relay via ACSELERATOR® QuickSet™ SEL-5030 Software.
- Connect the relay to a PC using a SEL-C234A serial or SEL-C662 USB cable.
  - Apply power to the relay.
  - Start the ACSELERATOR QuickSet software program and establish communication with relay.
  - Click on the **Read Settings From Device** icon  to download the current settings from the relay.
  - Save the downloaded setting file into your ACSELERATOR QuickSet database.

### Trip and Close Logic

TDURD Minimum Trip Time (seconds)	<input type="text" value="0.5"/>	Range = 0.0-400.0
CFD Close Failure Time Delay (seconds)	<input type="text" value="0.5"/>	Range = 0.0-400.0
TR Trip (SELogic)	<input type="text" value="ORED50T OR ORED51T OR 81D1T OR 81D2T"/>	

- Step 2. Edit the ACSELERATOR QuickSet relay settings file.
- Edit the trip logic equation (TR), found under **Group 1 > Set 1 > Trip and Close Logic** in the **Settings Tree View**, by deleting “ORED50T OR” from the TR equation.
  - Edit the SV01 SELOGIC Variable, found under **Group 1 > Logic 1 > SELogic Variables and Timers**, by adding “OR (50P1P AND LT01)” to the end of the equation to allow a trip signal if the instantaneous element is triggered and latch bit 1 (LT01) is active.
  - Any other instantaneous elements (50PxT, 50NnT, 50GnT, or 50QnT) that are active and desired for tripping must also be added individually to the SV01 SELOGIC Variable equation.

- d. Confirm that the trip logic for the selected trip output contact OUT103 (located in **Group 1 > Logic 1 > Slot A**) is set with **OUT103 := TRIP**.
- e. Set latch bit 1 (LT01) to set and reset when pushbutton 1 (PB01) is pressed (located in **Group 1 > Logic 1 > SELogic Latch Bits**) as follows:

**SET1 := NOT LT01 AND PB01\_PUL AND LT02**  
**RST1 := LT01 AND PB01\_PUL AND LT02**

- f. Set the instantaneous phase overcurrent element pickup (50P1P) to the correct value for your system (located at **Group 1 > Set 1 > Overcurrent Elements > Phase Overcurrent**). When determining the 50P1P setting to provide Arc Flash Protection, the engineer must set the 50P1P setting high enough to ensure it will not pickup under maximum load conditions. Typically on feeders (or mains or ties with no phase instantaneous setting on the feeders) a setting of 1.5 times the expected maximum load current is selected.

- g. Enable one additional display point by setting **EDP := 5** under **Front Panel > General**.

- h. Set the front-panel display point to display when arc flash protection is enabled under **Front Panel > Display Point**.

**DPO5 := LT01,, "ARC PROT ARMED"**

- i. Enable one additional SELOGIC Variable by setting **ESV := 6** under **Group 1 > Logic 1 > SELogic Enables**.

- j. Set the pushbutton 1 target LEDs to indicate when arc flash protection is active (flashing PB1A\_LED) or inactive (PB1B\_LED) under **Front Panel > Target LED**.

**PB01A\_LED := SV06T**  
**PB01B\_LED := NOT LT01**

- k. Setup the flashing LED timing under **Group 1 > Logic 1 > SELogic Variables and Timers**.

**SV06PU := 0.50**  
**SV06DO := 0.50**  
**SV06 := LT01 AND NOT SV06T**

- l. Set T01\_LED setting in **Front Panel > Target LED** for correct Instantaneous targeting by changing "T01\_LED := ORED50T" to "T01\_LED := (50P1 AND LT01) OR 50PxT OR 50NnT OR 50GnT OR 50QnT OR . . .", where x = 2, 3, or 4 and n = 1, 2, 3 or 4.

### SELogic Variables and Timers

SV01PU SV\_ Timer Pickup (seconds)  
 Range = 0.00-3000.00

SV01DO SV\_ Timer Dropout (seconds)  
 Range = 0.00-3000.00

SV01 SV\_ Input (SELogic)

### SELogic Latch Bits

SET01 (SELogic)

RST01 (SELogic)

### Display Points

DP01 Display Point (60 characters)

DP02 Display Point (60 characters)

DP03 Display Point (60 characters)

DP04 Display Point (60 characters)

DP05 Display Point (60 characters)

SV06PU SV\_ Timer Pickup (seconds)  
 Range = 0.00-3000.00

SV06DO SV\_ Timer Dropout (seconds)  
 Range = 0.00-3000.00

SV06 SV\_ Input (SELogic)

Step 3. Save the revised setting file into the database, and then with the settings still open, click the **Send Active Settings** icon  and then click **OK** when prompted to upload the revised settings into relay.

Step 4. The Operator Control label on the SEL-751A relay for pushbuttons PB01 through PB04 will need to be replaced, using the configurable label kit provided with the relay, with an Operator Control label that has pushbutton PB01 labeled as **ARC FLASH PROTECTION**, as shown in the adjacent figure.

It is important that Arc Flash Protection is not left on permanently as this will compromise device coordination and decrease reliability.



# Communication With Relay

There are three ways of communicating with the SEL-751A Feeder Relay. You can communicate with the relay using the Human Machine Interface (HMI) on the front panel, remote communications, or a direct computer connection. For direct serial communications, the computer must have a serial port (or USB port if using SEL-C662 USB cable) and the operating system should be Windows® 2000 or newer. A standard EIA-232 crossover cable or an SEL-234A cable will also be required.



SEL-751A relays are shipped with default passwords. To prevent unauthorized access, change default passwords to private passwords at installation. SEL shall not be responsible for damage resulting from unauthorized access.

## HMI Pushbuttons

Press the {TARGET RESET} pushbutton to clear targets that have been alarmed.

Press the {ESC} pushbutton to return to previous menu.

Press the directional (up, down, left, right) pushbuttons to scroll through options.

Press the {ENT} pushbutton for selection to see next menu.

## Computer Connection Steps

- Step 1. Connect the PC and the relay using a serial communications cable.
- Step 2. Apply power to both the PC and the relay.
- Step 3. Open a terminal emulation program.



### Option 1: ACSELERATOR® QuickSet™ SEL-5030 Software

Open ACSELERATOR QuickSet and proceed to *Step 4*. If you do not have ACSELERATOR QuickSet, you can download the program from [www.selinc.com/sel-5030.htm](http://www.selinc.com/sel-5030.htm). Refer to Section 3 of the SEL-751A manual for more information about ACSELERATOR QuickSet.

### Option 2: HyperTerminal

To open HyperTerminal go to **Start > Programs > Accessories > Communications > HyperTerminal**. Once there you will be prompted to enter a name of your choice for the connection. Then you will choose which port to connect through. Make sure you select the same port that you connected the cable to, then click **OK**.

- Step 4. Set the PC terminal emulation program to the same communications port settings as shown in the figure to the right and click **OK**.
- Step 5. Press the <Enter> key on the PC keyboard to check the communications link. You should see the = prompt. If you do not see the = prompt, check the cable connections, confirm that the settings in the terminal emulation program are the default values, and that the emulation mode is set to VT100.
- Step 6. Once connected, you can set all other relay settings and obtain values as needed. Refer to Section 6 in the SEL-751A manual for more information.

