

INSTRUCTION MANUAL

FOR

OVERCURRENT RELAYS

BE1-50/51B-214 and BE1-50/51B-225

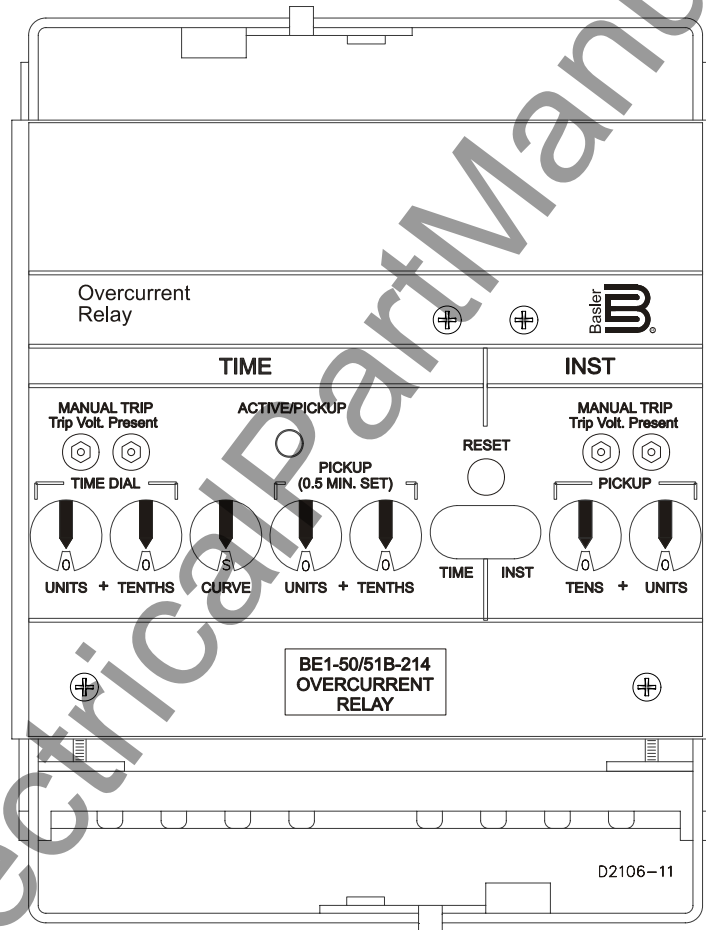

B Basler Electric

Publication: 9252000994
Revision: K 03/08

www.ElectricalPartManuals.com

INTRODUCTION

This instruction manual provides information about the operation and installation of the BE1-50/51B-214 and BE1-50/51B-225 Overcurrent Relays. To accomplish this, the following information is provided:

- General Information and Specifications
- Controls and Indicators
- Functional Description
- Installation and Maintenance
- Testing

WARNING!

To avoid personal injury or equipment damage, only qualified personnel should perform the procedures in this manual.

NOTE

Be sure that the relay is hard-wired to earth ground with no smaller than 12 AWG copper wire attached to the ground terminal on the rear of the unit case. When the relay is configured in a system with other devices, it is recommended to use a separate lead to the ground bus from each unit.

First Printing: July 1995

Printed in USA

© 2008 Basler Electric, Highland Illinois 62249 USA

All Rights Reserved

March 2008

CONFIDENTIAL INFORMATION

of Basler Electric, Highland Illinois, USA. It is loaned for confidential use, subject to return on request, and with the mutual understanding that it will not be used in any manner detrimental to the interest of Basler Electric.

It is not the intention of this manual to cover all details and variations in equipment, nor does this manual provide data for every possible contingency regarding installation or operation. The availability and design of all features and options are subject to modification without notice. Should further information be required, contact Basler Electric.

**BASLER ELECTRIC
ROUTE 143, BOX 269
HIGHLAND IL 62249 USA**

<http://www.basler.com>, info@basler.com

PHONE +1 618.654.2341

FAX +1 618.654.2351

REVISION HISTORY

The following information provides a historical summary of the changes made to this instruction manual (9252000994). Revisions are listed in reverse chronological order.

Manual Revision and Date	Change
K, 03/08	<ul style="list-style-type: none"> Updated front panel drawings to show new reset button and targets.
J, 01/07	<ul style="list-style-type: none"> Moved Time Characteristic Curve Figures to Appendix A. Moved Section 6, <i>Maintenance</i> information into Section 4, <i>Installation</i>.
H, 05/06	<ul style="list-style-type: none"> In Section 5, <i>Testing, Test Procedure, Models BE1-50/51B-225 (One Ampere Sensing Input) Time Dial Test</i>, corrected the elapsed time stated in step 2. Added the relay's metric weight to Section 1, <i>General Information, Specifications</i>. Moved contents of Section 7, <i>Manual Change Information</i> to the manual introduction and deleted Section 7.
G, 03/00	<ul style="list-style-type: none"> Added the required information to document part number 9252000225.
F, 12/00	<ul style="list-style-type: none"> Updated the drawings in Section 2 to reflect PC board updates. Updated the remainder of the manual to reflect switch designation change from SW8 to SW3. Added new functional description to the Active/Pickup LED (formerly designated Pickup LED).
E, 12/99	<ul style="list-style-type: none"> Changed all target test current references to 1 Aac. Deleted step 5 of Section 6, <i>Maintenance, Periodic Tests</i>.
D, 05/98	<ul style="list-style-type: none"> Added the patent number to Section 1, <i>General Information, Specifications</i>. Updated format of the manual.
C, 12/95	<ul style="list-style-type: none"> Added material to document the addition of five characteristic curves and ability to select curve groups GE IAC or ABB. Changed Section 5, <i>Testing</i> to use the GE IAC curve group.
B, 10/95	<ul style="list-style-type: none"> Changed Figure 5-2 and all references to the target testing current source from 0.2 to 1.0 amperes. Corrected various, minor typographical errors in Sections 1 and 2.
A, 08/95	<ul style="list-style-type: none"> Removed all references to switch SW8-4 being field settable.
—, 07/95	<ul style="list-style-type: none"> Initial release

www . ElectricalPartManuals . com

This page intentionally left blank.

CONTENTS

SECTION 1 • GENERAL INFORMATION	1-1
SECTION 2 • CONTROLS AND INDICATORS	2-1
SECTION 3 • FUNCTIONAL DESCRIPTION	3-1
SECTION 4 • INSTALLATION	4-1
SECTION 5 • TESTING	5-1
APPENDIX A • TIME CHARACTERISTIC CURVES	A-1

www.ElectricalPartManuals.com

www.ElectricalPartManuals.com

This page intentionally left blank.

SECTION 1 • GENERAL INFORMATION

TABLE OF CONTENTS

SECTION 1 • GENERAL INFORMATION	1-1
INTRODUCTION.....	1-1
FEATURES.....	1-1
Advantages.....	1-2
SPECIFICATIONS	1-2
Current Sensing Input	1-2
Time Overcurrent (51) Element.....	1-2
Instantaneous Overcurrent (50) Element	1-5
Burden	1-6
Frequency Response	1-7
Transient Response	1-7
Harmonic Response.....	1-7
Target Indicators	1-8
Output Contacts	1-8
Type Tests.....	1-8
Environment	1-9
Agency Recognition	1-9
Physical	1-9
Figures	
Figure 1-1. Integrating Reset Characteristic Curve	1-5
Figure 1-2. Instantaneous Characteristic Curves	1-6
Figure 1-3. Burden Characteristics.....	1-7
Figure 1-4. Harmonic Rejection.....	1-8
Tables	
Table 1-1. GE IAC Relays Suitable For Direct Replacement.....	1-1
Table 1-2. Time Characteristic Curve Constants with SW3-3 Open (Off).....	1-3
Table 1-3. Time Characteristic Curve Constants with SW3-3 Closed (On)	1-4

www . ElectricalPartManuals . com

This page intentionally left blank.

SECTION 1 • GENERAL INFORMATION

INTRODUCTION

BE1-50/51B-214 and BE1-50/51B-225 protective relays are direct replacements for General Electric, IAC relays. The BE1-50/51B-214 has a 5 ampere current sensing input. The BE1-50/51B-225 has a 1 ampere current sensing input. Compatible IAC model numbers are listed in Table 1-1.

Table 1-1. GE IAC Relays Suitable For Direct Replacement

IAC Model Number	Curve Type
12IAC51A***A	Inverse
12IAC51B***A	Inverse with Instantaneous
12IAC53A***A	Very Inverse
12IAC53B***A	Very Inverse with Instantaneous
12IAC55A***A	Short Time
12IAC55B***A	Short Time with Instantaneous
12IAC66A**A	Long Time
12IAC66B**A	Long Time with Instantaneous
12IAC77A***A	Extremely Inverse
12IAC77B***A	Extremely Inverse with Instantaneous

* Any digit covering all pickup ranges and 50 Hz or 60 Hz models.

To replace an existing IAC relay, perform the following steps.

1. Select the desired relay settings on your new BE1-50/51B-214 or BE1-50/51B-225 relay.
2. Remove the existing IAC relay.
3. Attach the cover adapter to the existing case.
4. Insert the new relay.
5. Reinstall the existing connection plug.
6. Install the new Basler Electric cover.

Basler Electric BE1-50/51B-214 and BE1-50/51B-225 protective relays are self-powered, microprocessor-based, non-directional phase or ground relays that monitor the magnitude of a single-phase ac current to provide accurate instantaneous and time overcurrent protection for 50 Hz or 60 Hz power systems. Each model covers 10 popular time characteristics and a wide range of pickup settings.

FEATURES

A wide range of pickup settings and front panel selectable time characteristics permit applications involving coordination with fuses, reclosers, cold load pickup, motor starting, and fixed time requirements. Also, an integrating reset function is available to simulate the disk reset of electromechanical relays.

BE1-50/51B-214 and BE1-50/51B-225 overcurrent relays have the following standard features.

- Independent time and instantaneous elements
- A secure method to manually trip the breaker at the relay front panel
- Direct reading front panel controls
- Minimum pickup setting for safety during installation
- Time characteristics extend to a pickup multiple of 40
- Rugged draw-out construction with steel case
- Gravity latching targets retain indication without power
- Built-in accuracy eliminates internal adjustments
- Minimum transient overreach
- Field selectable characteristic curve selection similar to either GE IAC or ABB type curves
- Field selectable instantaneous or integrating reset
- Field selectable 50 or 60 Hz operation
- Field selectable 0.0 or 0.1 second, fixed, instantaneous delay

Internal switches provide for selecting system operating frequencies of 50 or 60 Hz, instantaneous element delays of 0.0 or 0.1 second, characteristic curve group selection for either GE IAC or ABB type curves, and instantaneous or integrating reset characteristics. Switch location and description is provided in Section 2.

Advantages

BE1-50/51B-214 and BE1-50/51B-225 overcurrent relays have many advantages over other overcurrent relays. The primary advantages are:

- Time characteristics are defined by equations and graphs
- Field selectable time characteristics
- Very low burden extends the linear range of the CTs
- Self powered from the sensed current
- Continuous automatic calibration

BE1-50/51B-214 and BE1-50/51B-225 overcurrent relays may be tested without removing the relay from the case. Shorting contacts are provided for all current inputs when the connection plugs or relay chassis is removed from the relay case.

SPECIFICATIONS

BE1-50/51B-214 and BE1-50/51B-225 overcurrent relays have the following features and capabilities.

Current Sensing Input

BE1-50/51B-214

Continuous Current: 14 Aac
One Second Rating: 400 Aac

BE1-50/51B-225

Continuous Current: 2.8 Aac
One Second Rating: 80 Aac

Time Overcurrent (51) Element

Setting the TIME PICKUP control at the minimum pickup setting places the relay in the most sensitive state and may be used as a safety setting.

BE1-50/51B-214 Pickup

Setting Range: 0.5 to 15.9 Aac
Setting Increment: 0.1 Aac
Accuracy: $\pm 2\%$, ± 25 milliamperes at or above 0.5 ampere setting

BE1-50/51B-225 Pickup

Setting Range: 0.1 to 3.18 Aac
Setting Increment: 0.02 Aac
Accuracy: $\pm 2\%$, ± 5 milliamperes at or above 0.1 ampere setting

Dropout

Dropout occurs at 95% of pickup value.

Timing Range

0.0 to 9.9 seconds in 0.1 second steps.

Timing Accuracy

The timing accuracy is the sum of ± 1 cycle, $\pm 2\%$. This accuracy applies to the range of 1.3 to 40 times tap and is for a given measured multiple of tap. The measurement of the multiple of tap has an accuracy that is the sum of $\pm 2\%$, ± 25 milliamperes for the BE1-50/51B-214 and $\pm 2\%$, ± 5 milliamperes for the BE1-50/51B-225.

Timing Accuracy Example (BE1-50/51B-214)

PU setting: 5 amperes
 Current Applied: 6.5 amperes
 + Multiple Tolerance: 6.655 amperes
 – Multiple Tolerance: 6.345 amperes
 Time Curve: E
 Time Dial: 5.0
 Minimum time dial
 using 6.655 amperes: 46.5470 seconds
 Maximum time dial
 using 6.345 amperes: 61.3968 seconds
 Curve time using 6.5 amperes: 53.1800 seconds

Curve Characteristics

Nine inverse time functions and one fixed time function can be selected by the front-panel Curve switch. Characteristic curves for the inverse and definite time functions are defined by the following equation.

$$T_T = \frac{AD}{M^N - C} + BD + K$$

Where: T_T = time to trip in seconds
 D = time dial setting
 M = multiple of pickup setting
 A, B, C, N, K = constants for the particular curve

Time characteristic curve constants are listed in Tables 1-2 and 1-3. Constants have been selected to conform to the characteristics of electromechanical relays over a range of pickup multiples from 1.3 to 40. Values of the constants are provided for use in computer relay setting software. Timing accuracy is ± 1 cycle, ± 2 percent of time to trip.

Table 1-2. Time Characteristic Curve Constants with SW3-3 Open (Off)

Curve Type *		Figure Number †	Constants					
BE1	Similar To		A	B	C	N	K	R
S	ABB CO-2	A-1	0.2663	0.03393	1.000	1.2969	0.028	0.500
L	ABB CO-5	A-2	5.6143	2.18592	1.000	1.000	0.028	15.750
D	ABB CO-6	A-3	0.4797	0.21359	1.000	1.5625	0.028	0.875
M	ABB CO-7	A-4	0.3022	0.12840	1.000	0.5000	0.028	1.750
I	ABB CO-8	A-5	8.9341	0.17966	1.000	2.0938	0.028	9.000
V	ABB CO-9	A-6	5.4678	0.10814	1.000	2.0469	0.028	5.500
E	ABB CO-11	A-7	7.7624	0.02758	1.000	2.0938	0.028	7.750
B	BS142-B ‡	A-8	1.4638	0.00000	1.000	1.0469	0.028	3.250
C	BS142-C ‡	A-9	8.2506	0.00000	1.000	2.0469	0.028	8.000
F	None §	N/A	0.0000	1.00000	0.000	0.0000	0.000	1.000

Table 1-3. Time Characteristic Curve Constants with SW3-3 Closed (On)

Curve Type *		Figure Number †	Constants					
BE1	Similar To		A	B	C	N	K	R
S	GE IAC 55	A-10	0.0286	0.0208	1.000	0.9844	0.028	0.0940
L	GE IAC 66	A-11	2.3955	0.00002	1.000	0.3125	0.028	7.8001
D	ABB CO-6	A-3	0.4797	0.21359	1.000	1.5625	0.028	0.8750
M	ABB CO-7	A-4	0.3022	0.12840	1.000	0.5000	0.028	1.7500
I	GE IAC 51	A-12	0.2747	0.1042	1.000	0.4375	0.028	0.8868
V	GE IAC 53	A-13	4.4309	0.0991	1.000	1.9531	0.028	5.8231
E	GE IAC 77	A-14	4.9883	0.0129	1.000	2.0469	0.028	4.7742
B	BS142-B ‡	A-8	1.4636	0.00000	1.000	1.0469	0.028	3.2500
C	BS142-C ‡	A-9	8.2506	0.00000	1.000	2.0469	0.028	8.0000
F	None §	N/A	0.0000	1.00000	0.000	0.0000	0.000	1.0000

Notes for Tables 1-2 and 1-3

* BE1 Curve Types:

S: Short Inverse

V: Very Inverse

L: Long Inverse

E: Extremely Inverse

D: Definite Time

B: BS142 Very Inverse

M: Moderately Inverse

C: BS142 Extremely Inverse

I: Inverse

F: Fixed Time Delay

† Figure numbers refer to the characteristic curves located in Appendix A, *Time Characteristic Curves*.

‡ Curves B and C are defined in British Standard BS142 and IEC Standard IEC 255-4.

§ Fixed time delay, adjustable from 0.1 to 9.9 seconds.

Integrating Reset

Reset begins when the current drops below 95% of pickup. Integrating reset simulates the disk reset of electromechanical relays. BE1-50/51B-214 and BE1-50/51B-225 relays provide the integrating reset function even when input current falls to zero.

Integrating reset characteristics are defined by the following equation and shown in Figure 1-1. Equation constants are provided in Tables 1-2 or 1-3.

Integrating Reset Equation:

$$T_R = \frac{RD}{M^2 - 1}$$

Where:

T_R = Time to reset in seconds

R = Constant for the particular curve

D = TIME DIAL setting

M = Current in multiples of PICKUP setting during reset

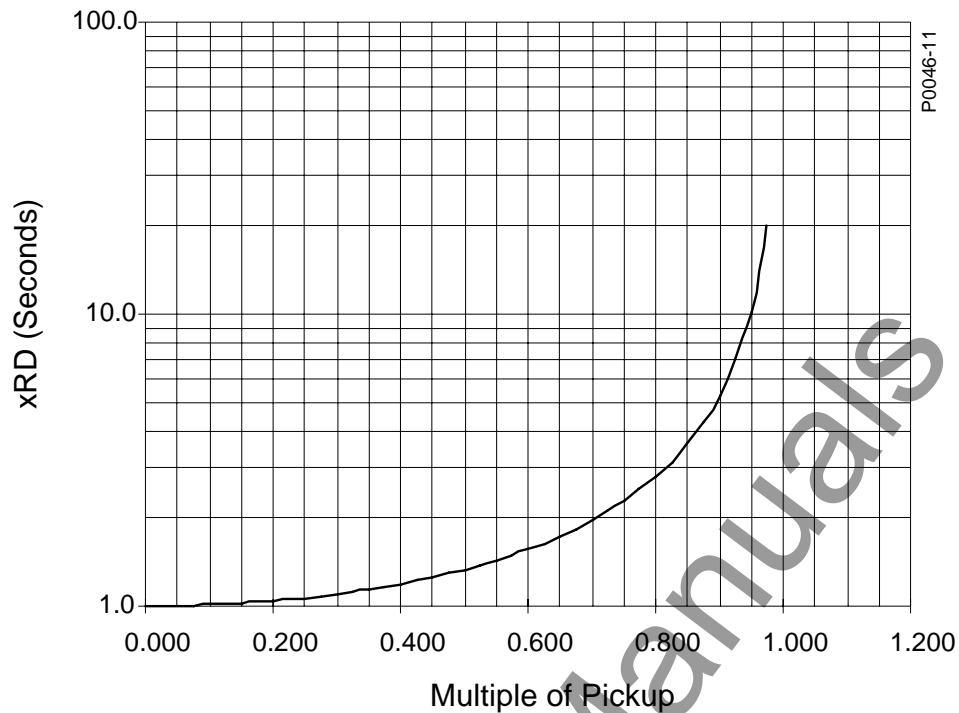

Vertical axis xRD (Seconds) is applicable for all curves and is derived from multiplying the constant R for the curve selected times D (the Time Dial setting).

Figure 1-1. Integrating Reset Characteristic Curve

Instantaneous Overcurrent (50) Element

Setting the INST PICKUP control to the minimum pickup setting places the relay in the most sensitive state and may be used as a safety setting.

BE1-50/51B-214 Pickup

Setting Range: 1 to 99 Aac
 Setting Increment: 1 Aac
 Accuracy: $\pm 2\%$, ± 25 milliamperes at or above 1.0 ampere setting

BE1-50/51B-214 Pickup

Setting Range: 0.2 to 19.8 Aac
 Setting Increment: 0.2 Aac
 Accuracy: $\pm 2\%$, ± 2 milliamperes at or above 0.2 ampere setting

Dropout

Dropout occurs at 95% of pickup value.

Curve Characteristics

Instantaneous characteristic curves are similar to standard electromechanical instantaneous units. However, the time to trip for applications where the initial current through the relay is less than 0.4 ampere (5 ampere relay) or 0.08 ampere (1 ampere relay) may be slightly longer. This may occur on a very lightly loaded circuit or when the relay is providing ground protection and is connected to measure neutral current. Figure 1-2 shows the instantaneous characteristic curves for maximum time to trip.

An additional fixed delay of 0.1 second may be added with internal switch SW3-2. This delay applies to both phase and ground applications. Closing switch SW3-2 provides an additional delay of 0.1 second. Section 2 illustrates the location of SW3.

The instantaneous element in BE1-50/51B-214 and BE1-50/51B-225 relays may be set lower than the instantaneous element in IAC relays and still have the same reach. This is because the BE1-50/51B-214 and BE1-50/51B-225 instantaneous element effectively eliminates the fault current transient overreach components. When calculating BE1-50/51B-214 and BE1-50/51B-225 relay instantaneous element settings, calculate the symmetrical value without any adder for transient overreach.

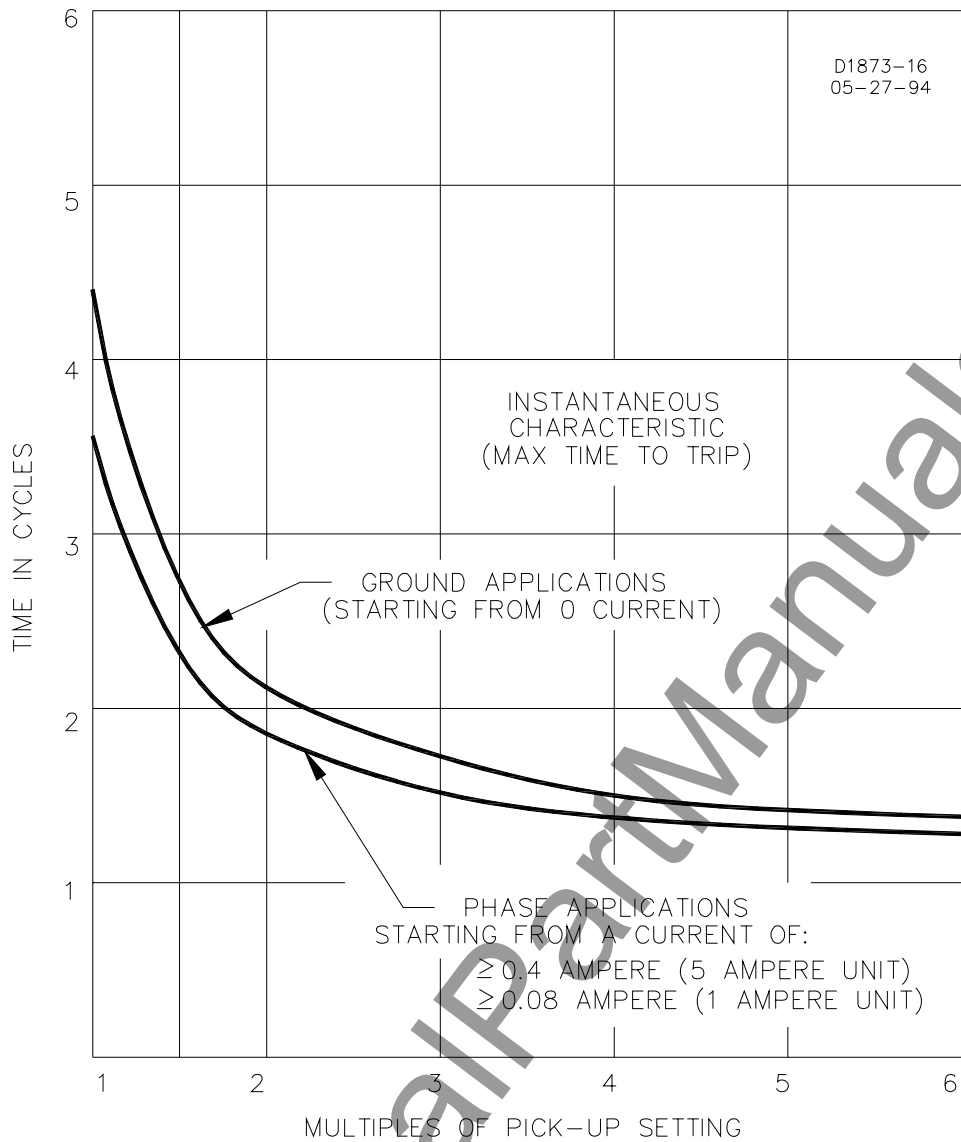

Figure 1-2. Instantaneous Characteristic Curves

Burden

Burden is non-linear. Figure 1-3 illustrates the device burden.

BE1-50/51B-214

At 0.5 amperes: 4.8 Ω
 At 5.0 amperes: 0.2 Ω

BE1-50/51B-225

At 0.1 ampere: 120 Ω
 At 1.0 ampere: 5 Ω

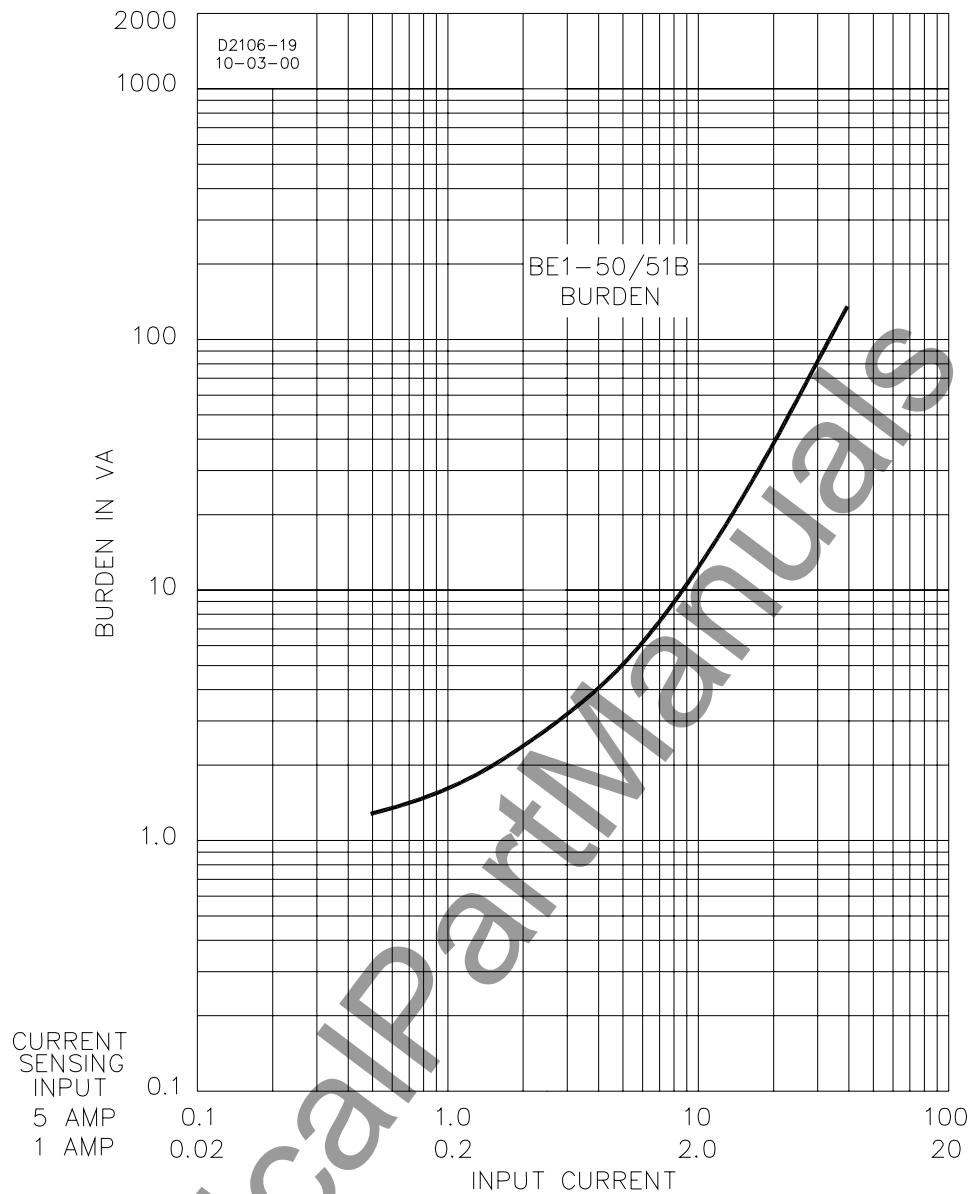

Figure 1-3. Burden Characteristics

Frequency Response

A change of ± 5 Hz from the nominal 50/60 Hz current causes $<0.5\%$ change in the current required for pickup.

Transient Response

$<10\%$ overreach with system time constants up to 40 ms.

Harmonic Response

Figure 1-4 shows that a relay set for 1 ampere pickup would pick up at 0.96 amperes with a current containing 40% seventh harmonic. This corresponds to a 10:1 rejection ratio. Other conditions may be evaluated in the same manner.

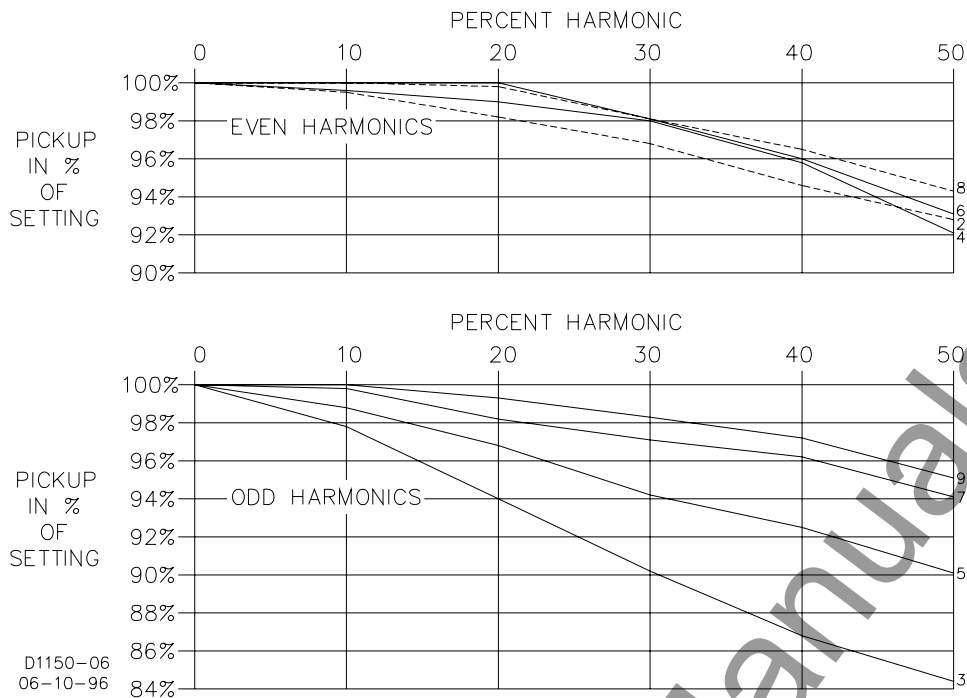

Figure 1-4. Harmonic Rejection

Target Indicators

Gravity latched, manually reset targets indicate that current of 0.2 amperes or greater was present in the trip circuit. Target coil resistance is less than 0.1 ohms and operate time is less than one millisecond. See *Output Contacts* for maximum current rating.

Output Contacts

Output contacts are surge protected and rated as follows.

Resistive Ratings

120/240 Vac: Make 30 amperes for 0.2 seconds, carry 7 amperes for 2 minutes, 3 amperes continuously, and break 5 amperes.

125/250 Vdc: Make 30 amperes for 0.2 seconds, carry 7 amperes for 2 minutes, 3 amperes continuously, and break 0.3 ampere.

Inductive Ratings

120/240 Vac, 125/250 Vdc: Make and carry 30 amperes for 0.2 seconds, carry 7 amperes for 2 minutes, 3 amperes continuously, and break 0.3 ampere. (L/R = 0.04).

Type Tests

Isolation

Meets IEC 255-5 and exceeds IEEE C37.90-1989, one-minute dielectric (high potential) tests as follows.

All circuits to ground: 2,828 Vdc
 Input to Output Circuits: 2,000 Vac or 2,828 Vdc

Surge Withstand Capability

Qualified to IEEE C37.90.1-1989 *Standard Surge Withstand Capability (SWC) Tests for Protective Relays and Relay Systems*.

Impulse

Qualified to IEC 255-5.

Radio Frequency Interference (RFI)

Field-tested using a 5-watt, hand-held transceiver operating at random frequencies centered around 144 MHz and 440 MHz, with the antenna located 6 inches from the relay in both horizontal and vertical planes.

Vibration

Withstands 2 G in each of three mutually perpendicular planes swept over the range of 10 to 500 Hz for a total of 6 sweeps, 15 minutes each sweep.

Shock

Withstands 15 G in each of three mutually perpendicular planes.

Environment

Operating Temperature: -40°C to 70°C (-40°F to 158°F)
Storage Temperature: -50°C to 70°C (-58°F to 158°F).

Agency Recognition

GOST-R Certification

GOST-R certified No. POCC US.ME05.B03391; complies with the relevant standards of Gosstandart of Russia. Issued by accredited certification body POCC RU.0001.11ME05.

Physical

Weight: 6.1 lb (2.77 kg)

www.ElectricalPartManuals.com

This page intentionally left blank.

SECTION 2 • CONTROLS AND INDICATORS

TABLE OF CONTENTS

SECTION 2 • CONTROLS AND INDICATORS	2-1
INTRODUCTION.....	2-1

Figures

Figure 2-1. Front Panel Controls and Indicators	2-1
Figure 2-2. Location of SW3.....	2-2

Tables

Table 2-1. BE1-50/51B-214 and BE1-50/51B-225 Controls and Indicators.....	2-3
---	-----

www.ElectricalPartManuals.com

This page intentionally left blank.

SECTION 2 • CONTROLS AND INDICATORS

INTRODUCTION

Figure 2-1 illustrates the front panel controls and indicators of the BE1-50/51B-214 and BE1-50/51B-225. Figure 2-2 illustrates the location of switch SW3. Both illustrations have lettered call-outs that correspond to the control and indicator descriptions provided in Table 2-1.

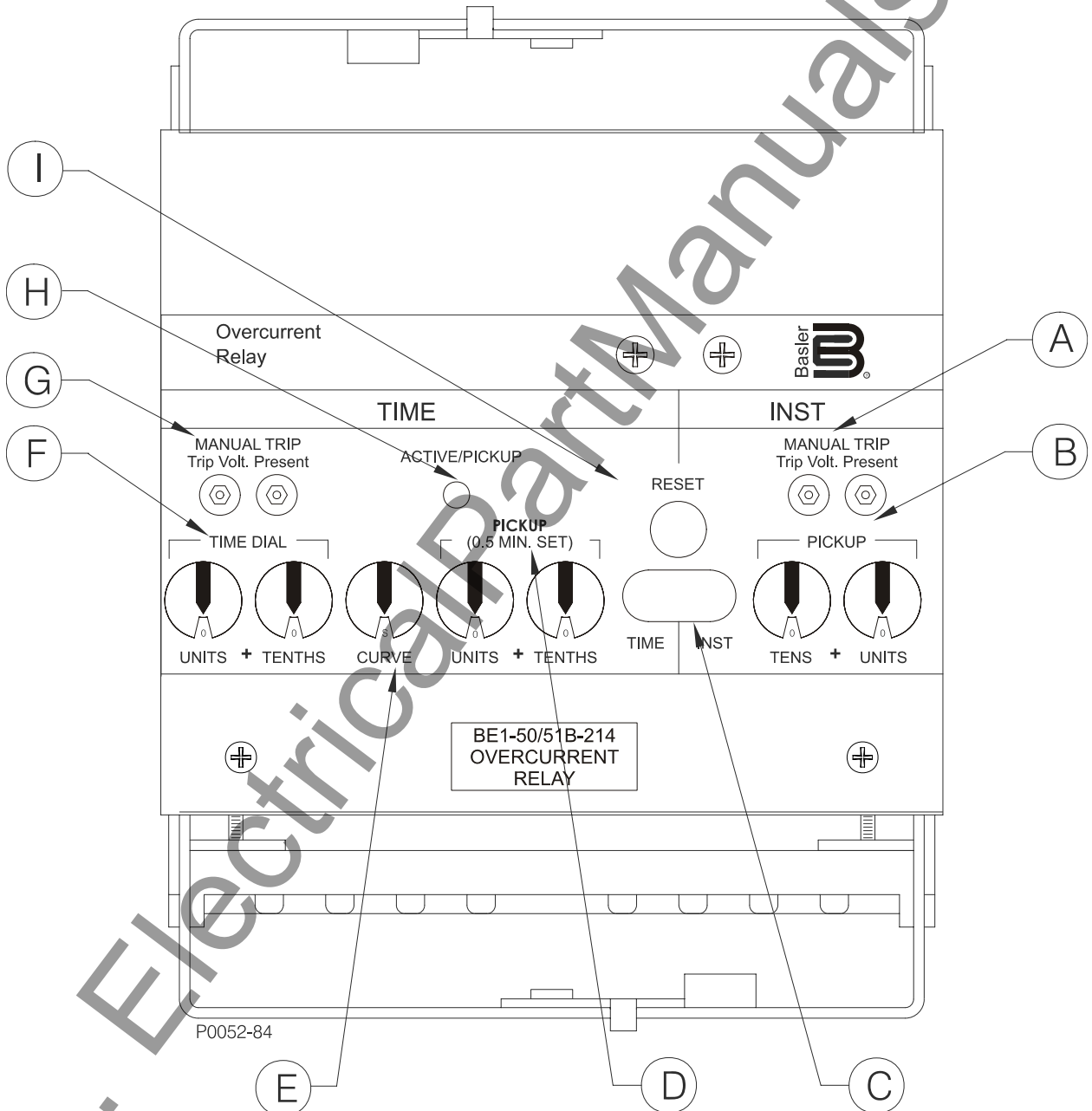

Figure 2-1. Front Panel Controls and Indicators

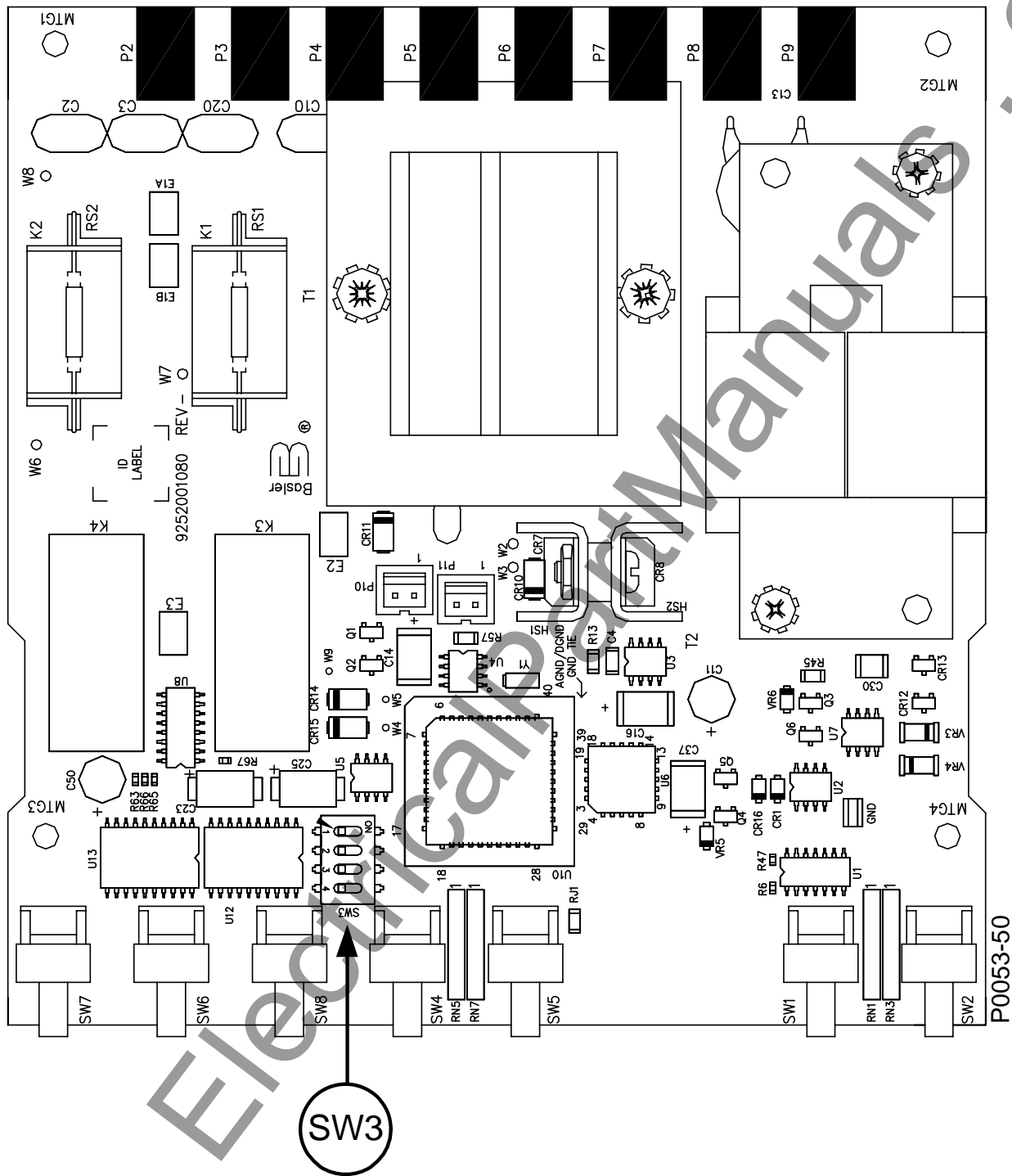

Figure 2-2. Location of SW3

Table 2-1. BE1-50/51B-214 and BE1-50/51B-225 Controls and Indicators (Refer to Figures 2-1 and 2-2)

Locator	Control or Indicator	Function
A	INST MANUAL TRIP Test Points	When shorted, the test points (jacks) provide a secure means to manually trip the controlled breaker. Jacks accept a standard 0.08 inch diameter phone tip plug.
B	INST PICKUP Selectors	Two switches (TENS and UNITS) to select pickup current in amperes. Changing switch selectors while the relay is in service may cause tripping.
C	Targets	Red target indicators latch when the trip circuit current is greater than 0.2 amperes. One target each for TIME and INST.
D	TIME PICKUP Selectors	Two switches (UNITS and TENTHS) to select pickup current in amperes. Changing switch selectors while the relay is in service may cause tripping.
E	CURVE Selector	Ten position selector switch to select one of nine inverse functions or one fixed time function.
F	TIME DIAL Selectors	Two selector switches (UNITS and TENTHS) to select the desired characteristic curve. A setting of 0.0 results in instantaneous operation without any intentional delay. A setting of 9.9 corresponds to the typical time provided by an electromechanical relay at its maximum dial setting.
G	TIME MANUAL TRIP Test Points	When shorted, the test points provide a secure means to manually trip the controlled breaker. Jacks accept a standard 0.08 inch diameter phone tip plug.
H	ACTIVE/PICKUP LED	Red LED indicates sensed current has exceeded the TIME PICKUP setting. LED turns from red to green when sensed current falls below 95% of pickup setting. When the LED is green, the relay is active but has not picked up.
I	Target RESET Button	Linkage extends through back of front cover to reset both gravity latched target indicators.
SW3 *	SW3-1	SW3-1 selects the system operating frequency. SW3-1 open (OFF) selects 60 Hz operation. SW3-1 closed (ON) selects 50 Hz operation.
	SW3-2	SW3-2 provides additional time delay for the instantaneous element. Closing switch SW3-2 (ON) provides an additional instantaneous delay of 0.1 second.
	SW3-3	SW3-3 provides selection of GE IAC type curves or ABB type curves. Closing switch SW3-3 (ON) selects GE IAC type curves (refer to Table 1-3). Opening switch SW3-3 (OFF) selects ABB type curves (refer to Table 1-2).
	SW3-4	SW3-4 provides selection of either instantaneous or integrating reset characteristics. Closing SW3-4 (ON) selects integrating reset characteristics. Opening SW3-4 (OFF) selects instantaneous reset characteristics.

* NOTE: In Revision J and previous relays, switch SW3 is designated as SW8.

www.ElectricalPartManuals.com

This page intentionally left blank.

SECTION 3 • FUNCTIONAL DESCRIPTION

TABLE OF CONTENTS

SECTION 3 • FUNCTIONAL DESCRIPTION	3-1
GENERAL	3-1
FUNCTIONAL DESCRIPTION	3-1
Sensing Input.....	3-1
Power Supply	3-1
Instantaneous Signal.....	3-1
Time Signal.....	3-1
Microprocessor	3-1
Power-Off Sensing	3-1
Outputs	3-2
Figures	
Figure 3-1. Functional Block Diagram	3-2

www . ElectricalPartManuals . com

This page intentionally left blank.

SECTION 3 • FUNCTIONAL DESCRIPTION

GENERAL

BE1-50/51B-214 and BE1-50/51B-225 Overcurrent Relays are microprocessor based non-directional relays that measure ac current to provide secure and reliable instantaneous and time overcurrent protection for power systems.

FUNCTIONAL DESCRIPTION

Sensing Input

Single phase ac current from system current transformers (CT) is brought into the Overcurrent Relay at terminals 5 and 6. Refer to Figure 3-1 to follow the functional description. The input current is applied to internal power and signal CTs.

Power Supply

Current from the power CT is rectified, filtered, and supplied to all relay internal circuitry for operating power. A precision +5 Vdc supply also serves as a reference for automatic calibration.

Instantaneous Signal

Current from the signal CT is rectified and applied to the instantaneous scaling resistors controlled by the INST PICKUP selector switches. The analog voltage of the instantaneous input signal developed across the scaling resistors is filtered and applied to the multiplexor (MUX).

Time Signal

Current from the signal CT is also rectified and applied to the time scaling resistors controlled by the TIME PICKUP selector switches. The analog voltage of the time input signal is also filtered and applied to the multiplexor.

Microprocessor

Operating power from the power supply is applied to the microprocessor supervisor circuit. When the microprocessor is active and executing code, the ACTIVE/PICKUP LED is green. When the input current falls below an acceptable level, the supervisor circuit interrupts the microprocessor, halts further operation, and turns OFF the ACTIVE/PICKUP LED. A microprocessor watchdog feature resets the microprocessor program when the program flow is interrupted.

Information from the TIME DIAL selector switches, the TIME CURVE selector switch, and the 50/60 Hz, INST DELAY, and RESET CHAR switches is also applied to the microprocessor. The microprocessor uses these inputs to set the operating parameters.

When the microprocessor is ready for analog information from the multiplexor, microprocessor control signals cause the multiplexor to route the desired input through to the output. The output is converted from an analog value to a digital value and applied to the microprocessor.

The microprocessor performs the program operations based on the inputs and the internal software program. When the sensed current exceeds the TIME PICKUP setting, the ACTIVE/PICKUP LED turns from green to red. TIME contacts (51) are closed in accordance with the time characteristic equation. If the sensed current exceeds the INST PICKUP setting, the INST contacts (50) are closed.

Power-Off Sensing

Power-off sensing circuits measure the voltage across a capacitor at power-down and at power-up. These circuits determine how long power has been removed based on the difference voltage and the circuit RC time constant. This provides information for the integrating reset function even when power has been entirely removed.

Outputs

Instantaneous and Timed

System circuit breakers controlled by the output contacts can be manually tripped by applying a short across the TIME or INST MANUAL TRIP front panel test points. Current flow in the trip circuit is indicated by the operation of the target. The targets will not operate without adequate operating power for the relay.

CAUTION

Trip circuit voltage is present at the front panel test points. When shorting the test points, use insulated jumpers to avoid contact with these voltages.

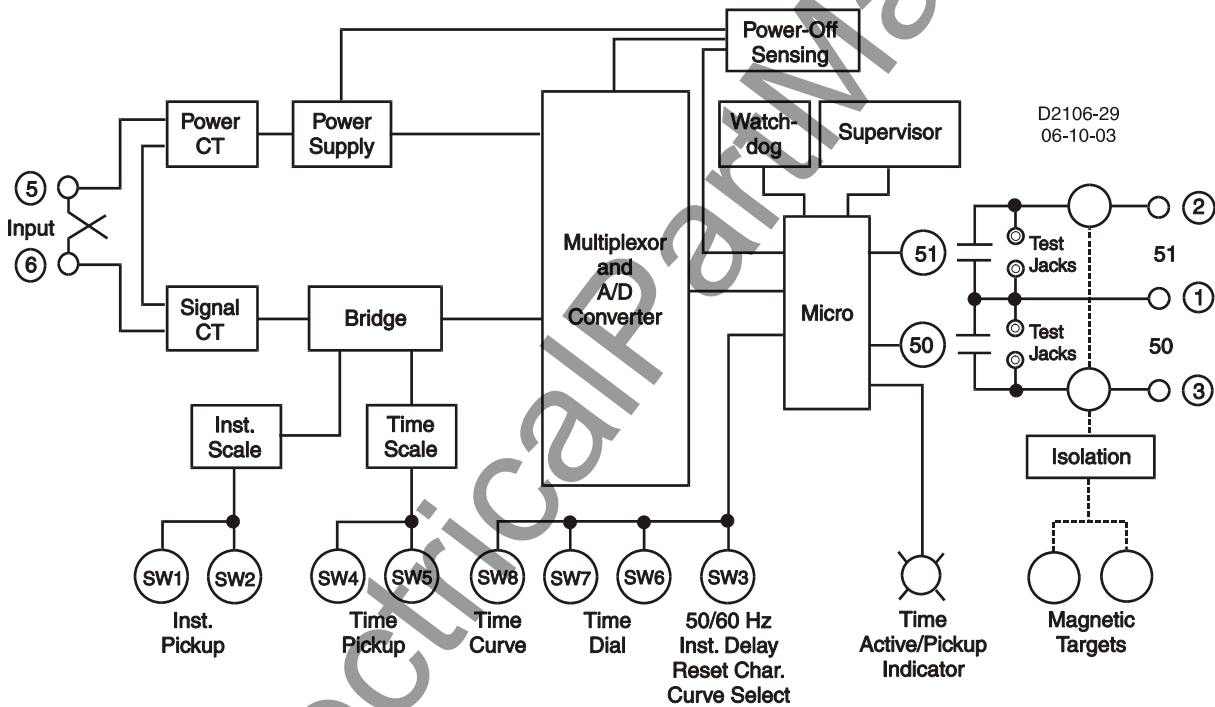

Figure 3-1. Functional Block Diagram

SECTION 4 • INSTALLATION

TABLE OF CONTENTS

SECTION 4 • INSTALLATION	4-1
GENERAL	4-1
FACTORY SETTINGS	4-1
INSTALLATION.....	4-1
APPLICATION COORDINATION	4-1
CONNECTIONS	4-3
MAINTENANCE	4-4
STORAGE.....	4-4

Figures

Figure 4-1. Coordination Timing Diagram	4-2
Figure 4-2. AC Input Connections	4-3
Figure 4-3. DC Control Connections	4-4

www.ElectricalPartManuals.com

This page intentionally left blank.

SECTION 4 • INSTALLATION

GENERAL

When not shipped as part of a control or switchgear panel, the relays are shipped in sturdy cartons to prevent damage during transit. Immediately upon receipt of a relay, check the model and part number against the requisition and packing list to see that they agree. Visually inspect the relay for damage that may have occurred during shipment. If there is evidence of damage, immediately file a claim with the carrier and notify the Regional Sales Office, or contact the Sales Representative at Basler Electric, Highland, Illinois.

Proper operation of the relay may be confirmed by performing the operational test procedure of Section 5. If the relay won't be installed immediately, store the relay in its original shipping carton in a moisture and dust-free environment.

FACTORY SETTINGS

Factory settings for the internal switches of SW3 are as follows:

- SW3-1 — OFF (60 hertz operation).
- SW3-2 — OFF (0.0 additional fixed delay for the instantaneous element).
- SW3-3 — ON (GE IAC type characteristic curves).
- SW3-4 — ON (Integrating reset characteristics).

INSTALLATION

Select the desired relay settings before putting the relay into service. Changing pickup current settings while the relay is in service may cause tripping. Perform the following procedures to install the BE1-50/51B-214 or BE1-50/51B-225 relay.

- Select the desired relay settings on your new BE1-50/51B-231 relay.
- Remove the existing IAC relay.
- Use the four screws provided and attach the cover adapter to the existing case.
- Insert the new relay and close the cradle latches locking the relay into the case.
- Reinstall the existing connection plug.
- To install the cover, position the interlocking bracket at the top of the new Basler Electric cover into the mating receptacle at the top of the cover adapter plate. Secure the captive fastener at the bottom of the cover.

APPLICATION COORDINATION

In a typical application coordination scheme, a BE1-50/51B-214 or BE1-50/51B-225 is being used to provide primary protection for a radial distribution feeder. An electromechanical overcurrent relay with extremely inverse timing provides protection for the transformer and bus. To improve coordination with the electromechanical relay, the BE1 relay with integrating reset characteristic has the time characteristic curve E (extremely inverse) selected (SW3-3 set to OFF) and the TIME DIAL set to 2.0. The feeder reclosing relay is set for two reclose attempts at 3 and 15 seconds after the initial trip. If a permanent fault occurs (magnitude ten times pickup), calculate the feeder breaker trip time for each of the three operations. Refer to Section 1 for characteristic curve constants.

From the time characteristic curve equation.

$$\begin{aligned}T_{\text{Trip}} &= \frac{AD}{M^N - C} + BD + K \\ &= \frac{7.7624 \times 2}{10^{2.0938} - 1} + (0.02758 \times 2) + 0.028 \\ &= \frac{15.5248}{124.10806 - 1} + (0.05516) + 0.028 \\ &= 0.29 \text{ seconds}\end{aligned}$$

From the reset characteristic curve equation.

$$T_{\text{Reset}} = \frac{RD}{M^2 - 1}$$

$$= \frac{7.75 \times 2}{0^2 - 1} = -15.5 \text{ seconds}$$

M = 0 if current goes to zero.

Negative result indicates reset time.

Results: Full trip = 0.209 seconds and full reset = 15.5 seconds if current goes to zero.

In Figure 4-1,

$T_A = 0.209$ seconds (relay was at reset).

$T_B = \text{value} < T_A$ because rewind has not gone to zero.

$T_C = \text{value} < T_A$ because rewind has not gone to zero.

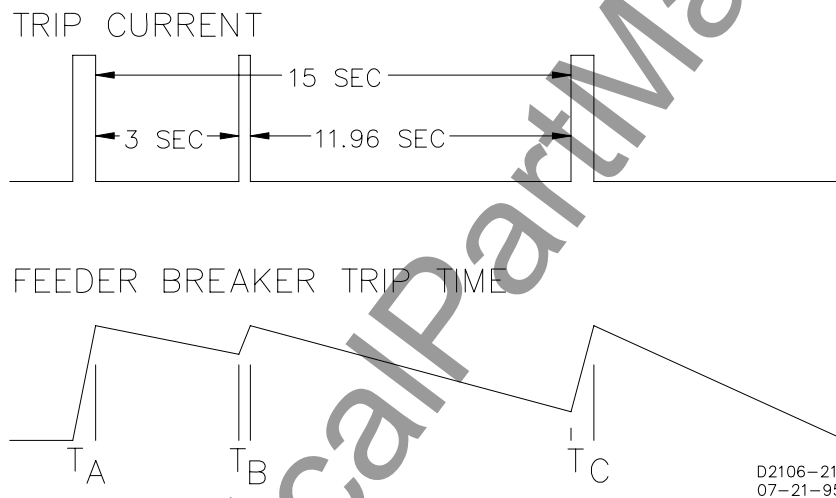

Figure 4-1. Coordination Timing Diagram

Equation for time to trip during rewind (before relay is reset).

$$T_{\text{Trip This Occurence}} = \frac{(\text{Full Trip})(\text{Rewind Time})}{\text{Full Rewind}}$$

Second Operation

$$T_B = \frac{(0.209)(3)}{15.5}$$

$$T_B = 0.040 \text{ seconds}$$

Third Operation

$$T_C = \frac{(0.209)(11.96)}{15.5}$$

$$T_C = 0.161 \text{ seconds}$$

CONNECTIONS

Typical ac input and dc control connections are shown in Figures 4-2 and 4-3. Refer to the block diagram in Section 3 for relay internal connections.

NOTE

Be sure that the relay is hard-wired to earth ground with no smaller than 12 AWG copper wire attached to the ground terminal on the rear of the unit case. When the relay is configured in a system with other devices, it is recommended to use a separate lead to the ground bus from each unit.

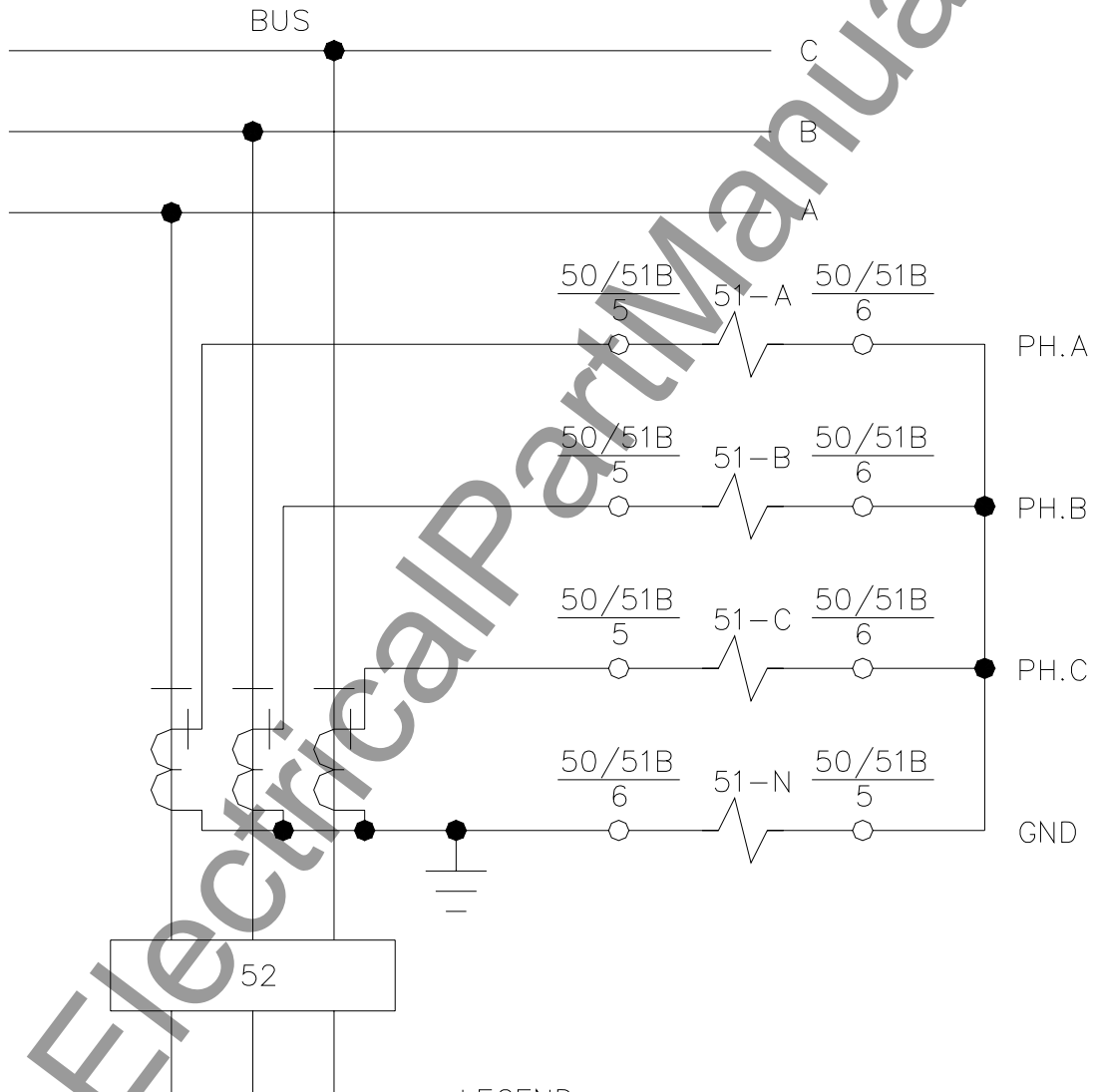

LEGEND:

- 50/51B OVERCURRENT RELAY
- 52 POWER CIRCUIT BREAKER

D2106-15
06-14-95

Figure 4-2. AC Input Connections

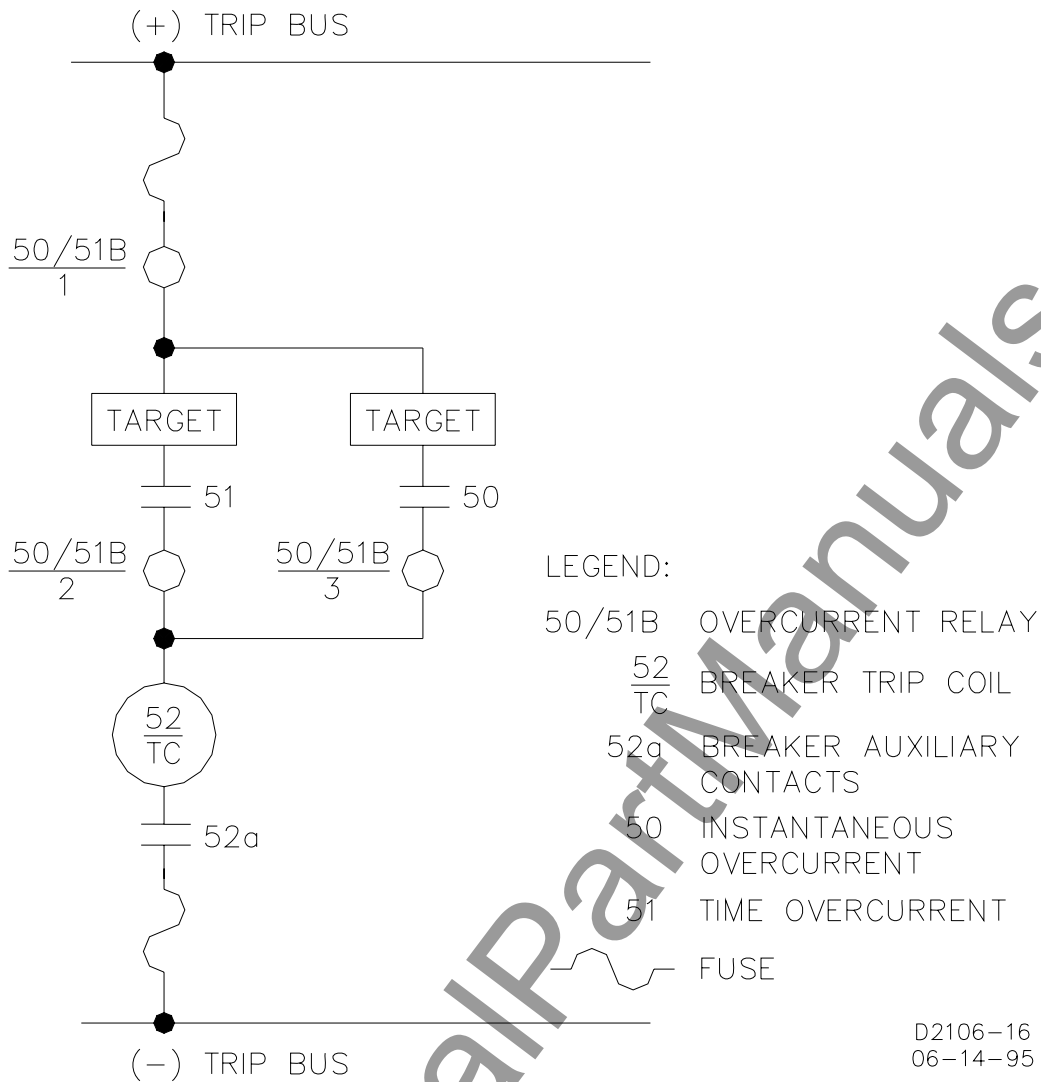

Figure 4-3. DC Control Connections

MAINTENANCE

BE1-50/51B-214 and BE1-50/51B-225 overcurrent relays require no preventive maintenance. However, periodic checks should be performed according to scheduled practices. A recommended periodic test is provided in Section 5. If the relay fails to function properly, contact the Technical Sales Support Department of Basler Electric.

STORAGE

This protective relay contains long-life, aluminum, electrolytic capacitors. Life in excess of 20 years may be expected if the storage temperature does not exceed 40°C (104°F).

SECTION 5 • TESTING

TABLE OF CONTENTS

SECTION 5 • TESTING	5-1
GENERAL	5-1
DIELECTRIC TEST	5-1
OPERATIONAL TEST PROCEDURE	5-1
Test Equipment Required.....	5-1
Test Procedure, Models BE1-50/51B-214 (Five Ampere Sensing Input)	5-3
Test Procedure, Models BE1-50/51B-225 (One Ampere Sensing Input)	5-5
SETTING THE RELAY	5-7
PERIODIC TESTS	5-7
General.....	5-7
Periodic Test.....	5-7
Figures	
Figure 5-1. Pickup and Timing Test Setup	5-2
Figure 5-2. Target Operational Test Setup.....	5-2

www . ElectricalPartManuals . com

This page intentionally left blank.

SECTION 5 • TESTING

GENERAL

Dielectric testing, operational testing, and periodic testing are described in the following paragraphs.

DIELECTRIC TEST

In accordance with IEC 255-5 and IEEE C37.90-1989, one-minute dielectric (high potential) tests may be performed as follows:

- | | |
|---------------------------|-------------------------|
| All circuits to ground: | 2,828 Vdc. |
| Input to output circuits: | 2,000 Vac or 2,828 Vdc. |

Output contacts are surge protected.

OPERATIONAL TEST PROCEDURE

The following procedures verify operation of relays BE1-50/51B-214 (5 ampere model) and BE1-50/51B-225 (1 ampere model). The test setup of Figures 5-1 and 5-2 are intended primarily as an illustration of the principles involved. Other test setups known to be capable of testing with the stated and implied tolerances (including equipment specifically designed for testing relays) may be used.

Test Equipment Required

- Current source with a range from 0 to 20 Aac (sensing input current)
- Current source 0.2 to 3 Aac (target operation)
- Timer or counter

CAUTION

To ensure proper timing during testing, before each test, remove the current from the unit for R times D seconds (refer to Section 1, *Specifications, Time Reset* for R and D definitions).

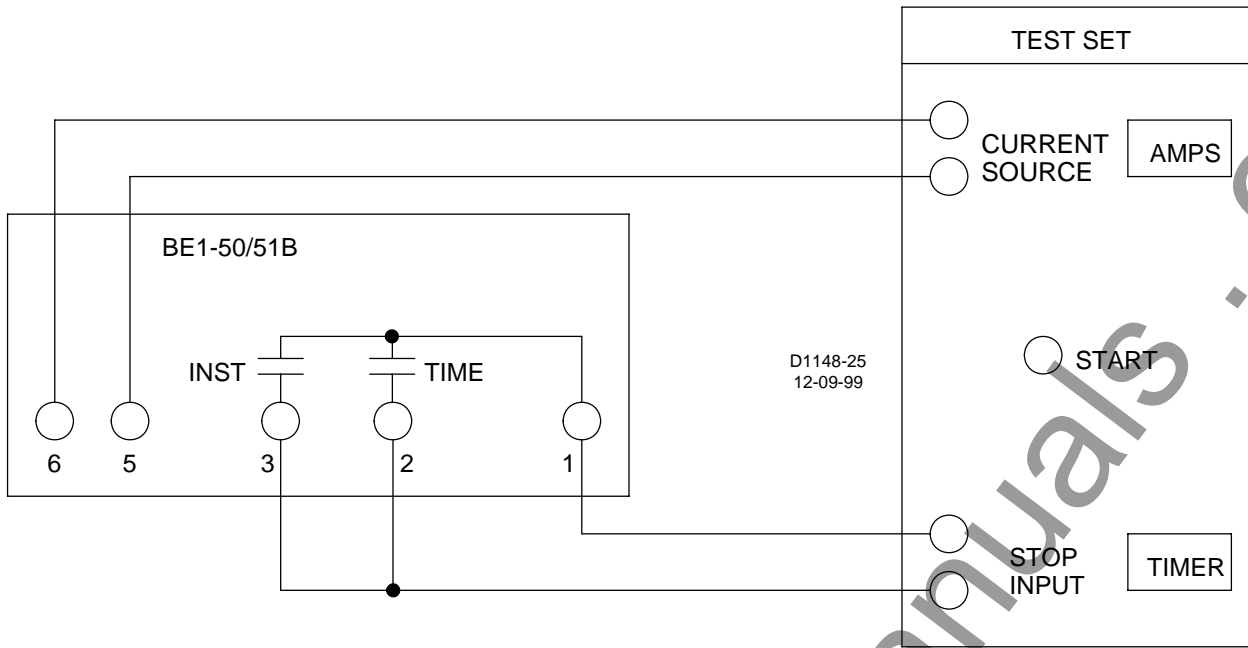

Figure 5-1. Pickup and Timing Test Setup

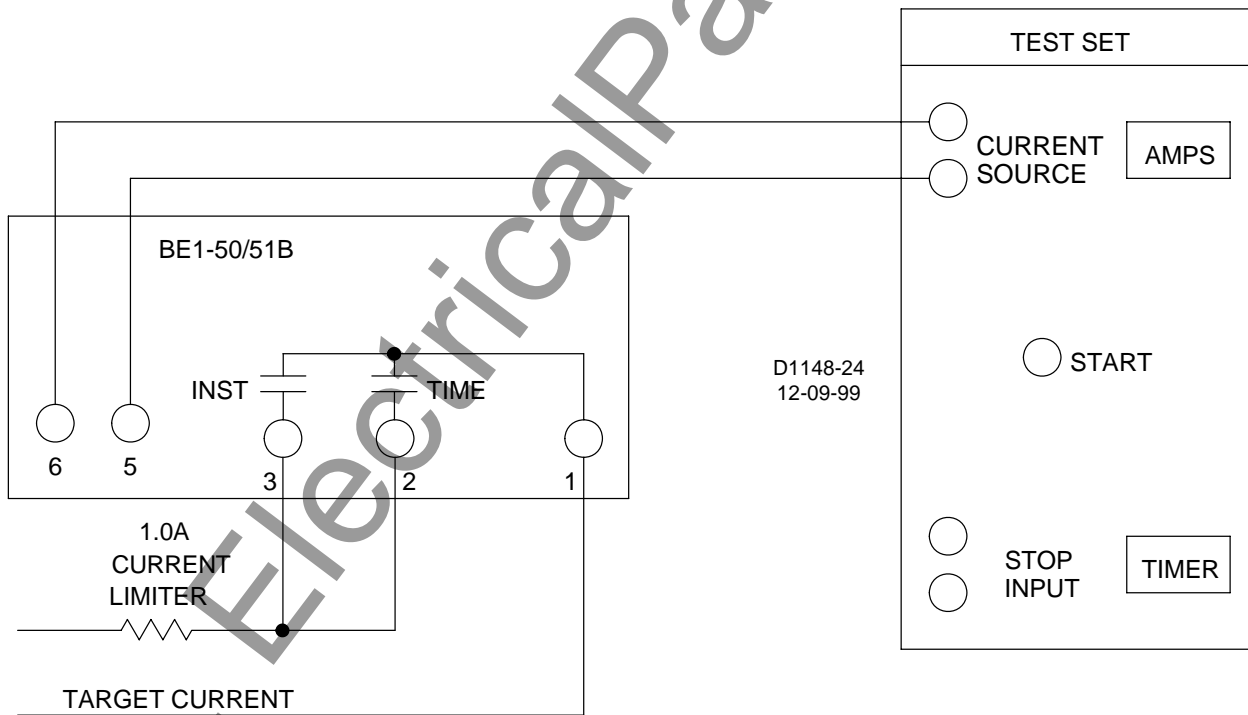

Figure 5-2. Target Operational Test Setup

NOTE

When testing TIME overcurrent functions, INST PICKUP settings of 00 will affect the calibration of the TIME functions. TIME PICKUP settings of 00 also affect INST functions.

Test Procedure, Models BE1-50/51B-214 (Five Ampere Sensing Input)

Time Pickup Test

Perform preliminary setup:

- Connect test setup as shown in Figure 5-1.
- Insure that SW3 switches are set: SW3-1 for the operating frequency, SW3-2 to OFF, SW3-3 to ON and SW3-4 to ON.
- Set TIME DIAL to 0.0.
- Set CURVE to S
- Set TIME PICKUP to 0.5.
- Set INST PICKUP to 90.

Step 1. Slowly increase current to terminals 5 and 6. PICKUP LED should turn RED at a maximum input current of 0.550 ampere.

Step 2. Decrease input current until PICKUP LED turns GREEN then OFF.

Step 3. Set TIME PICKUP to 2.2.

Step 4. Slowly increase current to terminals 5 and 6. PICKUP LED should change from GREEN to RED at an input current of 2.131 to 2.269 amperes.

Step 5. Decrease input current until PICKUP LED turns OFF.

INST Pickup Test

Perform preliminary setup:

- Connect test setup as shown in Figure 5-1.
- Insure that SW3 switches are set: SW3-1 for the operating frequency, SW3-2 to OFF, SW3-3 to ON, and SW3-4 ON.
- Set TIME DIAL to 0.0.
- Set CURVE to S
- Set TIME PICKUP to 1.0.
- Set INST PICKUP to 01.

Step 1. Slowly increase current to terminals 5 and 6. INST contacts should close at an input current of 0.955 to 1.045 amperes.

Step 2. Decrease input current until INST output contacts open.

Step 3. Set INST PICKUP to 08.

Step 4. Slowly increase current to terminals 5 and 6. INST contacts should close at an input current of 7.815 to 8.185 amperes.

Step 5. Decrease input current until INST output contacts open.

Time Dial Test

Perform preliminary setup:

- Connect test setup as shown in Figure 5-1.
- Insure that SW3 switches are set: SW3-1 for the operating frequency, SW3-2 to OFF, SW3-3 to ON, and SW3-4 ON.
- Set TIME DIAL to 4.5.
- Set CURVE to S
- Set TIME PICKUP to 1.0.
- Set INST PICKUP to 90.

Step 1. Prepare to apply 1.5 amperes input current to terminals 5 and 6 and record the elapsed time from when current is applied until TIME output contacts close.

Step 2. Apply the current (step from 0 to 1.5 amperes) and record the elapsed time. Elapsed time should be 0.345 to 0.424 seconds. (This tolerance is greater than $\pm 2\%$ because it is the accumulation of both pickup and timing tolerances.)

Step 3. Remove input current.

Target Test

Perform preliminary setup:

- Connect test setup as shown in Figure 5-2.
- Insure that SW3 switches are set: SW3-1 for the operating frequency, SW3-2 to OFF, SW3-3 to ON, and SW3-4 ON.
- Set TIME DIAL to 4.5.
- Set CURVE to S
- Set TIME PICKUP to 1.0.
- Set INST PICKUP to 01.

Step 1. Set target current source to 1.0 ampere, ac.

Step 2. Apply 5 amperes input current to terminals 5 and 6. Check that both TIME and INST targets operate.

Step 3. Remove input current and reset targets.

Manual Trip Test

Perform preliminary setup:

- Connect test setup as shown in Figure 5-2.
- Insure that SW3 switches are set: SW3-1 for the operating frequency, SW3-2 to OFF, SW3-3 to ON, and SW3-4 ON.
- Set TIME DIAL to 4.5.
- Set CURVE to S
- Set TIME PICKUP to 1.0.
- Set INST PICKUP to 01.

CAUTION

Trip circuit voltage is present at the front panel test points. When shorting the test points, use insulated jumpers to avoid contact with these voltages.

Step 1. Set target current source to 1.0 ampere, ac.

Step 2. Apply 0.9 ampere input current to terminals 5 and 6. (0.9 ampere provides input power but stays below pickup.)

Step 3. Connect a jumper between TIME MANUAL TRIP test points. Check that TIME target operates.

Step 4. Connect a jumper between INST MANUAL TRIP test points. Check that INST target operates.

Step 5. Reset targets.

Integrating Reset Test

Perform preliminary setup:

- Connect test setup as shown in Figure 5-1.
- Insure that SW3 switches are set: SW3-1 for the operating frequency, SW3-2 to OFF, SW3-3 to ON, and SW3-4 ON.
- Set TIME DIAL to 9.9.
- Set CURVE to V.
- Set TIME PICKUP to 1.0.
- Set INST PICKUP to 90.

Step 1. Set target current source to 1.0 ampere, ac.

Step 2. Read all of Step 3 before beginning Step 3.

Step 3. Apply 4.0 amperes input current to terminals 5 and 6. After the unit trips, remove the input current for 29 ± 0.25 seconds, then reapply the 4.0 amperes input current. Record the elapsed time from the re-application of input current to the output retrip.

Result: Elapsed time should be 2.08 ± 0.4 seconds.

Test Procedure, Models BE1-50/51B-225 (One Ampere Sensing Input)

Time Pickup Test

Perform preliminary setup:

- Connect test setup as shown in Figure 5-1.
- Insure that SW3 switches are set: SW3-1 for the operating frequency, SW3-2 to OFF, SW3-3 to ON and SW3-4 to ON.
- Set TIME DIAL to 0.0.
- Set CURVE to S
- Set TIME PICKUP to 0.5.
- Set INST PICKUP to 18.0.

Step 1. Slowly increase current to terminals 5 and 6. PICKUP LED should turn RED at a maximum input current of 0.110 ampere.

Step 2. Decrease input current until PICKUP LED turns GREEN then OFF.

Step 3. Set TIME PICKUP to 0.44.

Step 4. Slowly increase current to terminals 5 and 6. PICKUP LED should change from GREEN to RED at an input current of 0.426 to 0.454 amperes.

Step 5. Decrease input current until PICKUP LED turns OFF.

INST Pickup Test

Perform preliminary setup:

- Connect test setup as shown in Figure 5-1.
- Insure that SW3 switches are set: SW3-1 for the operating frequency, SW3-2 to OFF, SW3-3 to ON, and SW3-4 ON.
- Set TIME DIAL to 0.0.
- Set CURVE to S
- Set TIME PICKUP to 3.02.
- Set INST PICKUP to 0.2

Step 1. Slowly increase current to terminals 5 and 6. INST contacts should close at an input current of 0.191 to 0.209 amperes.

Step 2. Decrease input current until INST output contacts open.

Step 3. Set INST PICKUP to 08.

Step 4. Slowly increase current to terminals 5 and 6. INST contacts should close at an input current of 1.563 to 1.637 amperes.

Step 5. Decrease input current until INST output contacts open.

Time Dial Test

Perform preliminary setup:

- Connect test setup as shown in Figure 5-1.
- Insure that SW3 switches are set: SW3-1 for the operating frequency, SW3-2 to OFF, SW3-3 to ON, and SW3-4 ON.
- Set TIME DIAL to 4.5.
- Set CURVE to S
- Set TIME PICKUP to 0.2.
- Set INST PICKUP to 18.0.

Step 1. Prepare to apply 0.3 amperes input current to terminals 5 and 6 and record the elapsed time from when current is applied until TIME output contacts close.

Step 2. Apply the current (step from 0 to 0.3 amperes) and record the elapsed time. Elapsed time should be 1.754 to 2.084 seconds. (This tolerance is greater than $\pm 2\%$ because it is the accumulation of both pickup and timing tolerances.)

Step 3. Remove input current.

Target Test

Perform preliminary setup:

- Connect test setup as shown in Figure 5-2.
- Insure that SW3 switches are set: SW3-1 for the operating frequency, SW3-2 to OFF, SW3-3 to ON, and SW3-4 ON.
- Set TIME DIAL to 4.5.
- Set CURVE to S
- Set TIME PICKUP to 0.2.
- Set INST PICKUP to 0.2.

Step 1. Set target current source to 1.0 ampere, ac.

Step 2. Apply 1 ampere input current to terminals 5 and 6. Check that both TIME and INST targets operate.

Step 3. Remove input current and reset targets.

Manual Trip Test

Perform preliminary setup:

- Connect test setup as shown in Figure 5-2.
- Insure that SW3 switches are set: SW3-1 for the operating frequency, SW3-2 to OFF, SW3-3 to ON, and SW3-4 ON.
- Set TIME DIAL to 4.5.
- Set CURVE to S
- Set TIME PICKUP to 0.2.
- Set INST PICKUP to 0.2.

CAUTION

Trip circuit voltage is present at the front panel test points. When shorting the test points, use insulated jumpers to avoid contact with these voltages.

Step 1. Set target current source to 1.0 ampere, ac.

Step 2. Apply 0.15 ampere input current to terminals 5 and 6. (0.15 ampere provides input power but stays below pickup.)

Step 3. Connect a jumper between TIME MANUAL TRIP test points. Check that TIME target operates.

Step 4. Connect a jumper between INST MANUAL TRIP test points. Check that INST target operates.

Step 5. Reset targets.

Integrating Reset Test

Perform preliminary setup:

- Connect test setup as shown in Figure 5-1.
- Insure that SW3 switches are set: SW3-1 for the operating frequency, SW3-2 to OFF, SW3-3 to ON, and SW3-4 ON.
- Set TIME DIAL to 4.5.
- Set CURVE to I.
- Set TIME PICKUP to 0.20.
- Set INST PICKUP to 18.0.

Step 1. Set target current source to 1.0 ampere, ac.

Step 2. Read all of Step 3 before beginning Step 3.

Step 3. Apply 0.8 amperes input current to terminals 5 and 6. After the unit trips, remove the input current for 20 ± 0.25 seconds, then reapply the 0.8 amperes input current. Record the elapsed time from the re-application of input current to the output retrip.

Result: Elapsed time should be 1.55 ± 0.3 seconds.

SETTING THE RELAY

Select the desired relay settings before putting the relay into service. Changing pickup current settings while the relay is in service may cause tripping.

PERIODIC TESTS

General

All relays should be tested periodically to identify and correct any problems that are found.

Single phase relays such as the BE1-50/51B-214 and BE1-50/51B-225 are normally used in groups of four (three phase and ground) on the protected circuit. This relay scheme allows each unit to be withdrawn one at a time for testing purposes without losing protection. Only three are required at any one time to sense all types of faults on a grounded wye system. Refer to Figures 5-1 and 5-2 for recommended test setups.

Periodic Test

Periodic testing should consist of the following procedures.

Step 1. Verify that the instantaneous pickup is within $\pm 2\%$ of the value set on the dials. Pickup occurs when the INST output contacts close.

Step 2. Verify that the time pickup is within $\pm 2\%$ of the value set on the dials. Pickup occurs when the LED turns GREEN then RED.

Step 3. Verify that the time to trip for the curve and time dial settings at a multiple of six is the same as the time given on the characteristic curve. Refer to Section 1 for the characteristics curves.

Step 4. Verify that the time to trip for the instantaneous element at a pickup multiple of 2 is not greater than the time given on the instantaneous characteristic curve. Refer to Section 1 for the instantaneous characteristic curve.

Step 5. Verify that the targets operate with one ac ampere of trip current in the trip circuits and that they can be reset using the RESET BUTTON.

www.ElectricalPartManuals.com

This page intentionally left blank.

APPENDIX A • TIME CHARACTERISTIC CURVES

TABLE OF CONTENTS

APPENDIX A • TIME CHARACTERISTIC CURVES	A-1
TIME CHARACTERISTIC CURVES	A-1

Figures

Figure A-1. Time Characteristic Curve, S-Short Inverse (SW3-3 OFF, Similar to ABB CO-2)	A-1
Figure A-2. Time Characteristic Curve, L-Long Inverse (SW3-3 OFF, Similar to ABB CO-5)	A-2
Figure A-3. Time Characteristic Curve, D-Definite Time (Similar to ABB CO-6)	A-3
Figure A-4. Time Characteristic Curve, M-Moderately Inverse (Similar to ABB CO-7)	A-4
Figure A-5. Time Characteristic Curve, I-Inverse (SW3-3 OFF, Similar to ABB CO-8)	A-5
Figure A-6. Time Characteristic Curve, V-Very Inverse (SW3-3 OFF, Similar to ABB CO-9)	A-6
Figure A-7. Time Characteristic Curve, E-Extremely Inverse (SW3-3 OFF, Similar to ABB CO-11)	A-7
Figure A-8. Time Characteristic Curve, BS142-B (BS142 Very Inverse)	A-8
Figure A-9. Time Characteristic Curve, BS142-C (BS142 Extremely Inverse)	A-9
Figure A-10. Time Characteristic Curve, S2-Short Inverse (SW3-3 ON, Similar to GE IAC 55)	A-10
Figure A-11. Time Characteristic Curve, L2-Long Inverse (SW3-3 ON, Similar to GE IAC 66)	A-11
Figure A-12. Time Characteristic Curve, I2-Inverse (SW3-3 ON, Similar to GE IAC 51)	A-12
Figure A-13. Time Characteristic Curve, V2-Very Inverse (SW3-3 ON, Similar to GE IAC 53)	A-13
Figure A-14. Time Characteristic Curve, E2-Extremely Inverse (SW3-3 ON, Similar to GE IAC 77)	A-14

www . ElectricalPartManuals . com

This page intentionally left blank.

APPENDIX A • TIME CHARACTERISTIC CURVES

TIME CHARACTERISTIC CURVES

Figures A-1 through A-14 illustrate the time characteristic curves that are programmed into the nonvolatile memory of this relay.

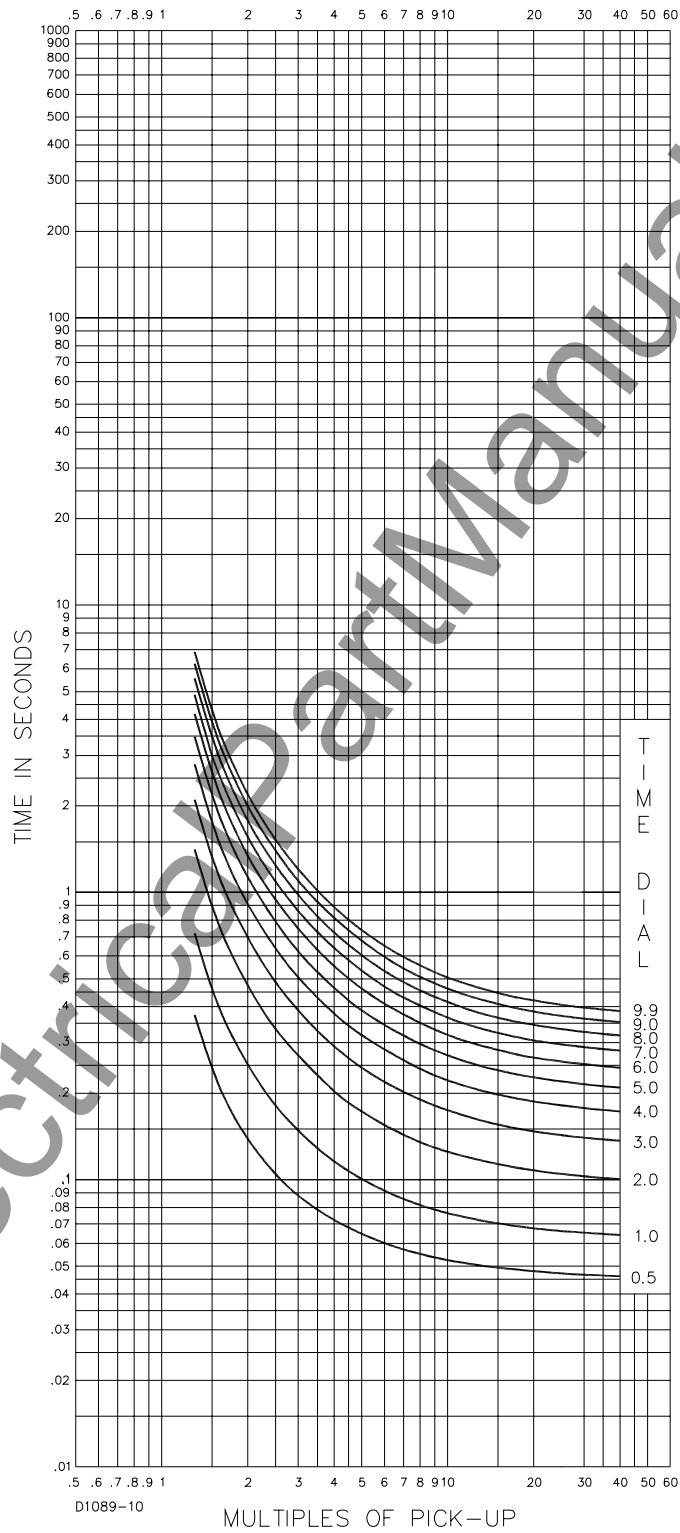

Figure A-1. Time Characteristic Curve, S-Short Inverse (SW3-3 OFF, Similar to ABB CO-2)

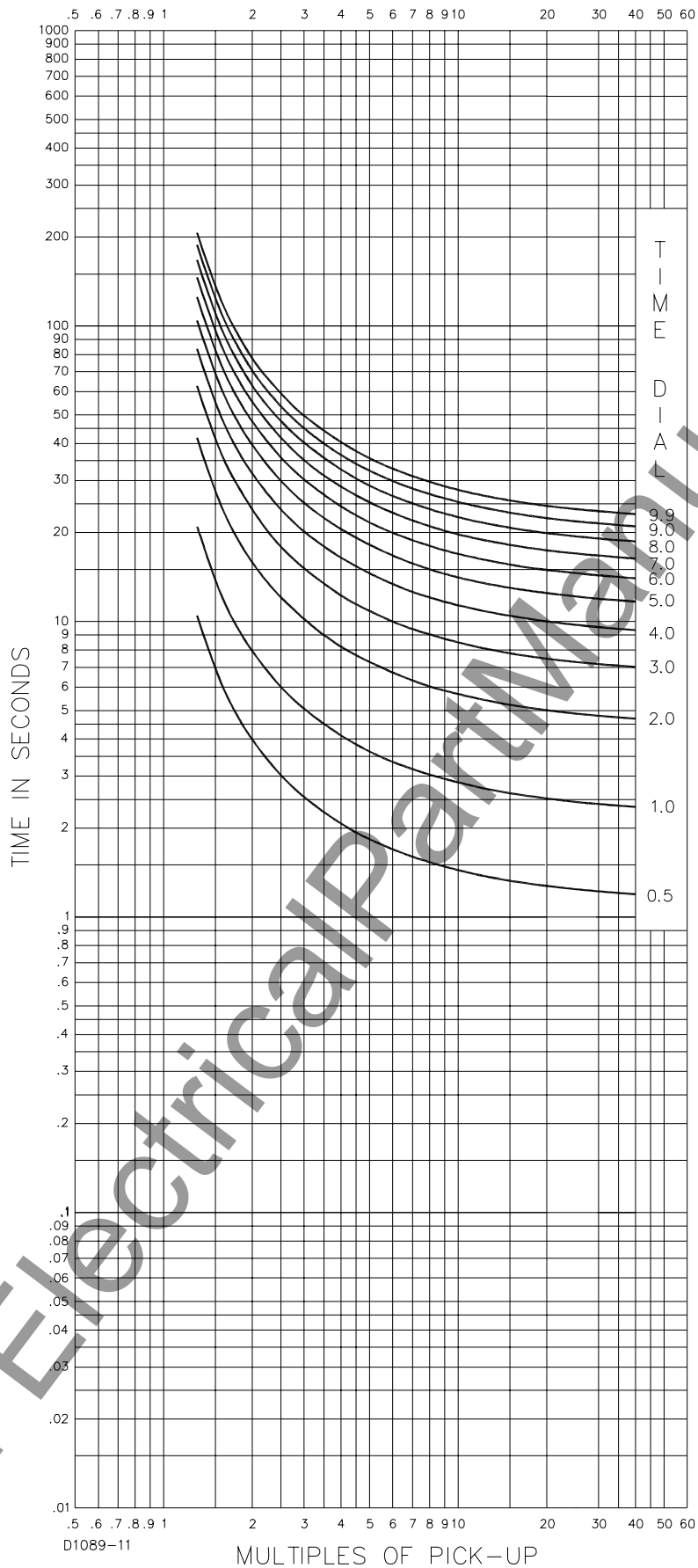

Figure A-2. Time Characteristic Curve, L-Long Inverse
(SW3-3 OFF, Similar to ABB CO-5)

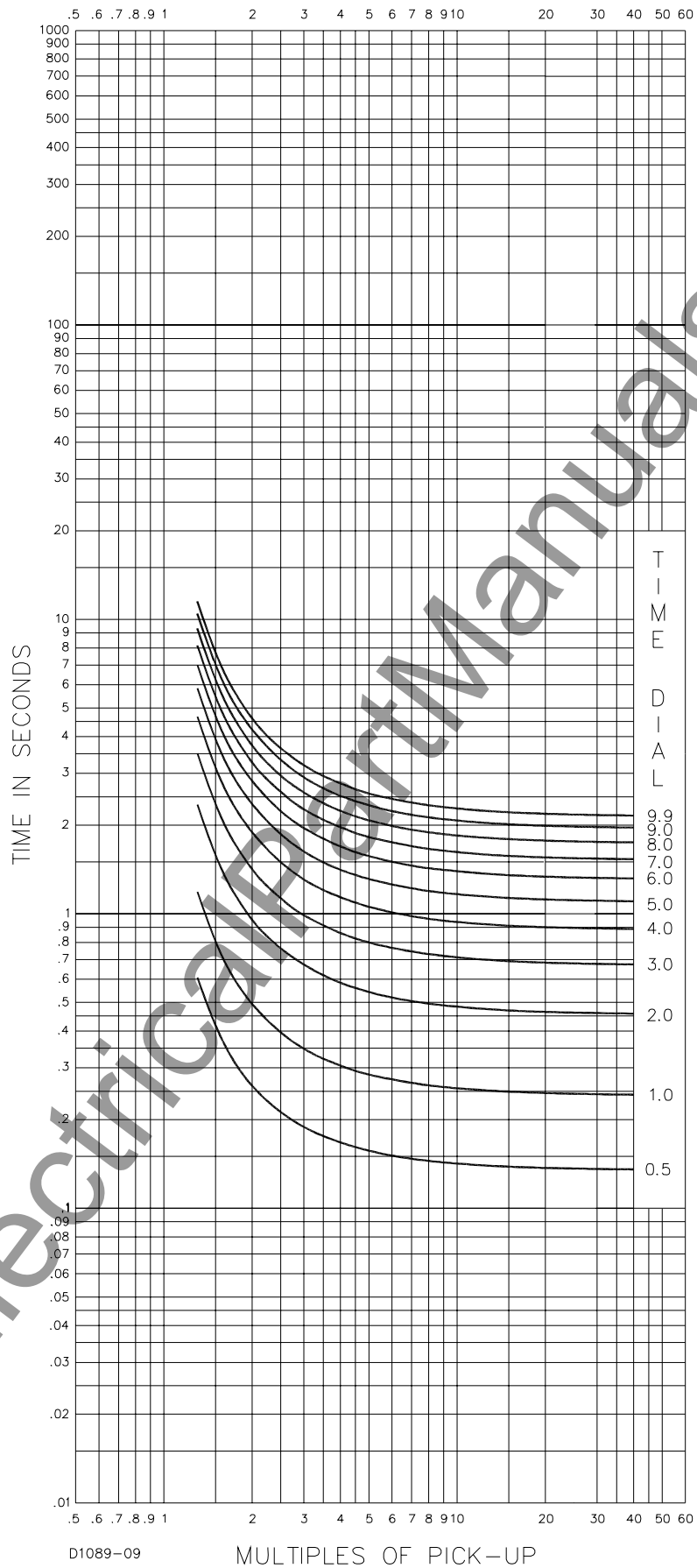

Figure A-3. Time Characteristic Curve, D-Definite Time
(Similar to ABB CO-6)

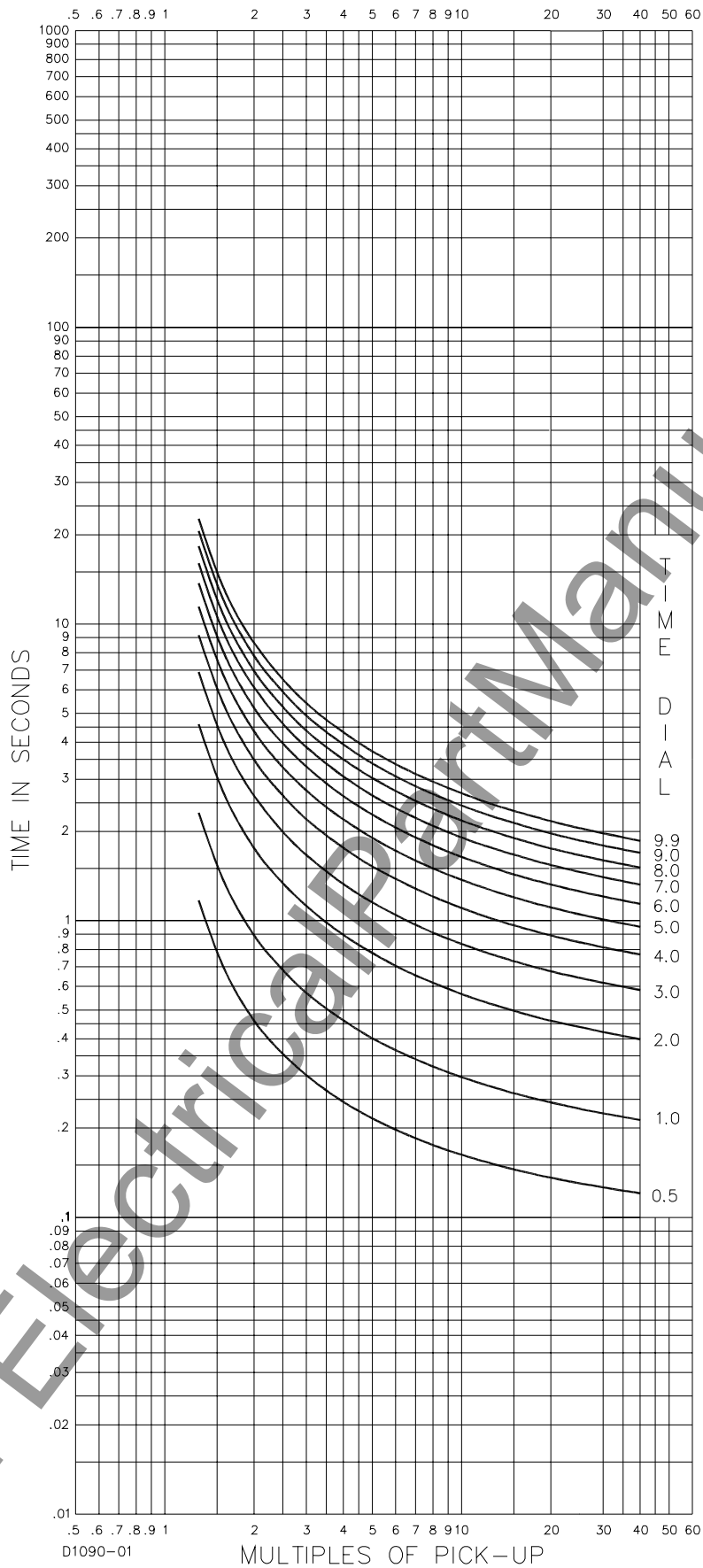

Figure A-4. Time Characteristic Curve, M-Moderately Inverse
(Similar to ABB CO-7)

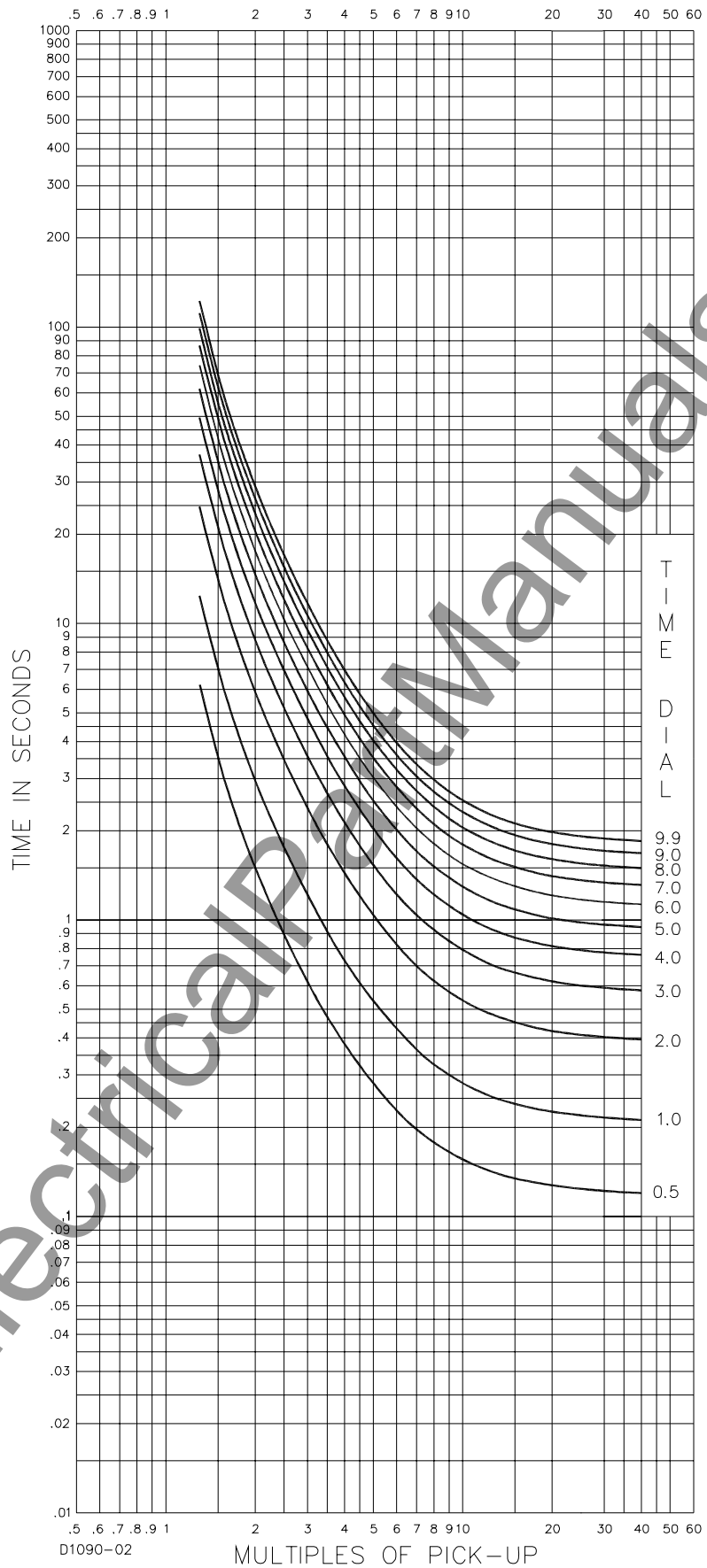

Figure A-5. Time Characteristic Curve, I-Inverse
(SW3-3 OFF, Similar to ABB CO-8)

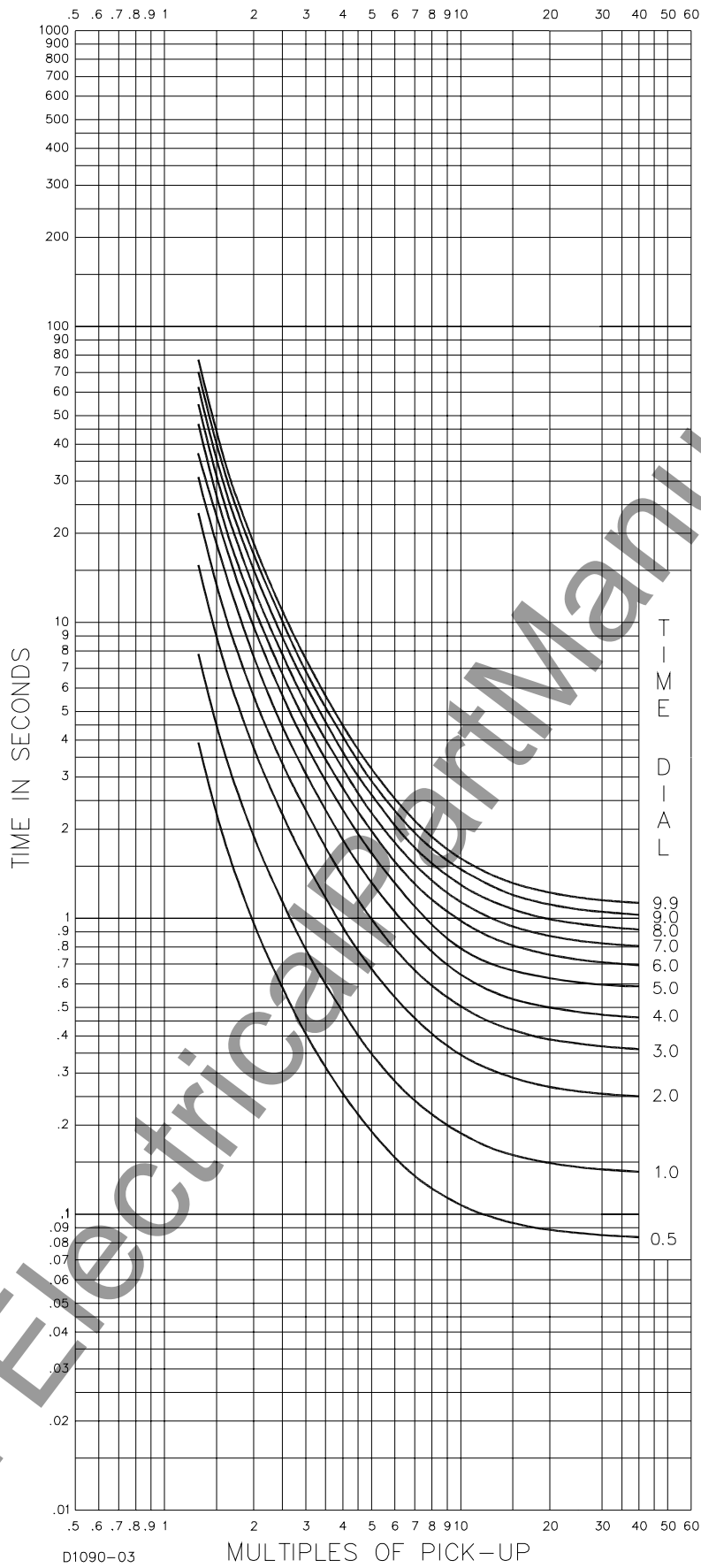

Figure A-6. Time Characteristic Curve, V-Very Inverse
(SW3-3 OFF, Similar to ABB CO-9)

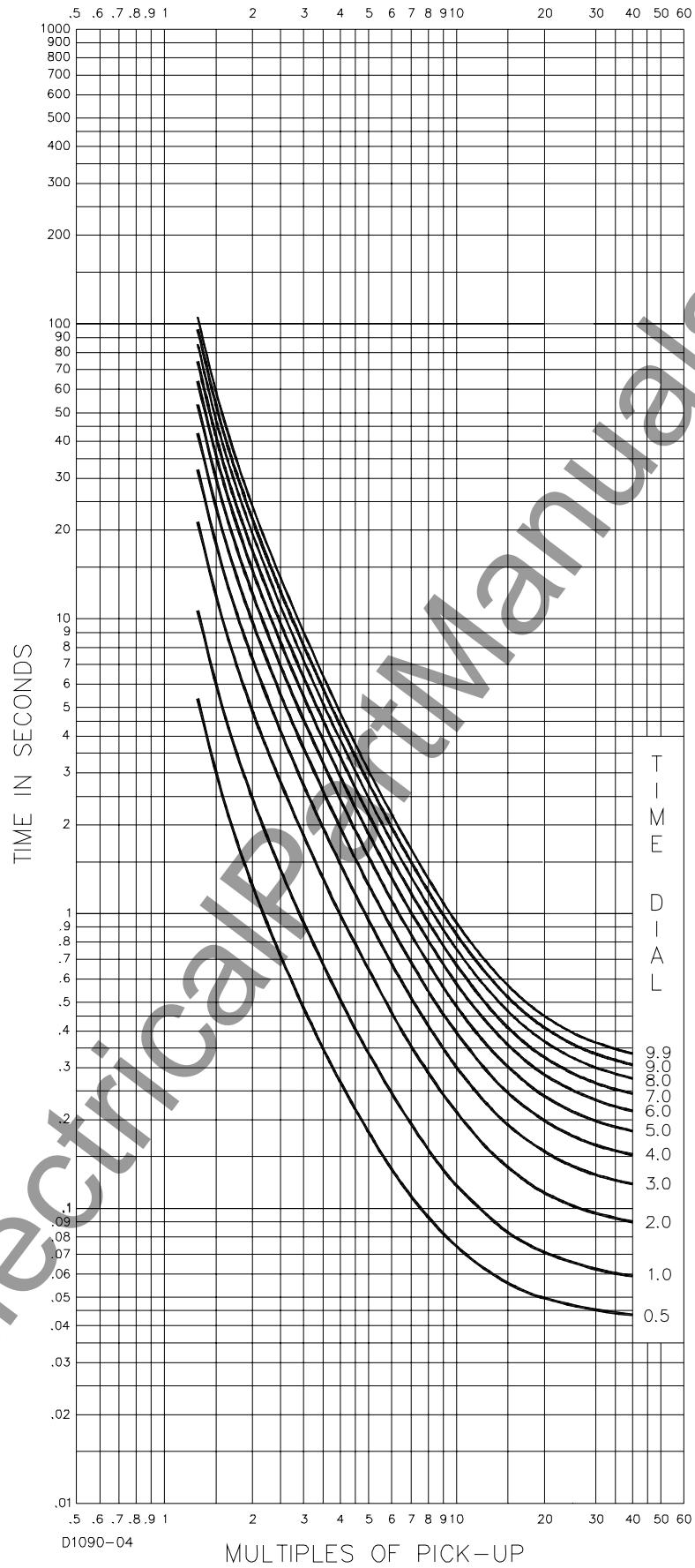

Figure A-7. Time Characteristic Curve, E-Extremely Inverse
(SW3-3 OFF, Similar to ABB CO-11)

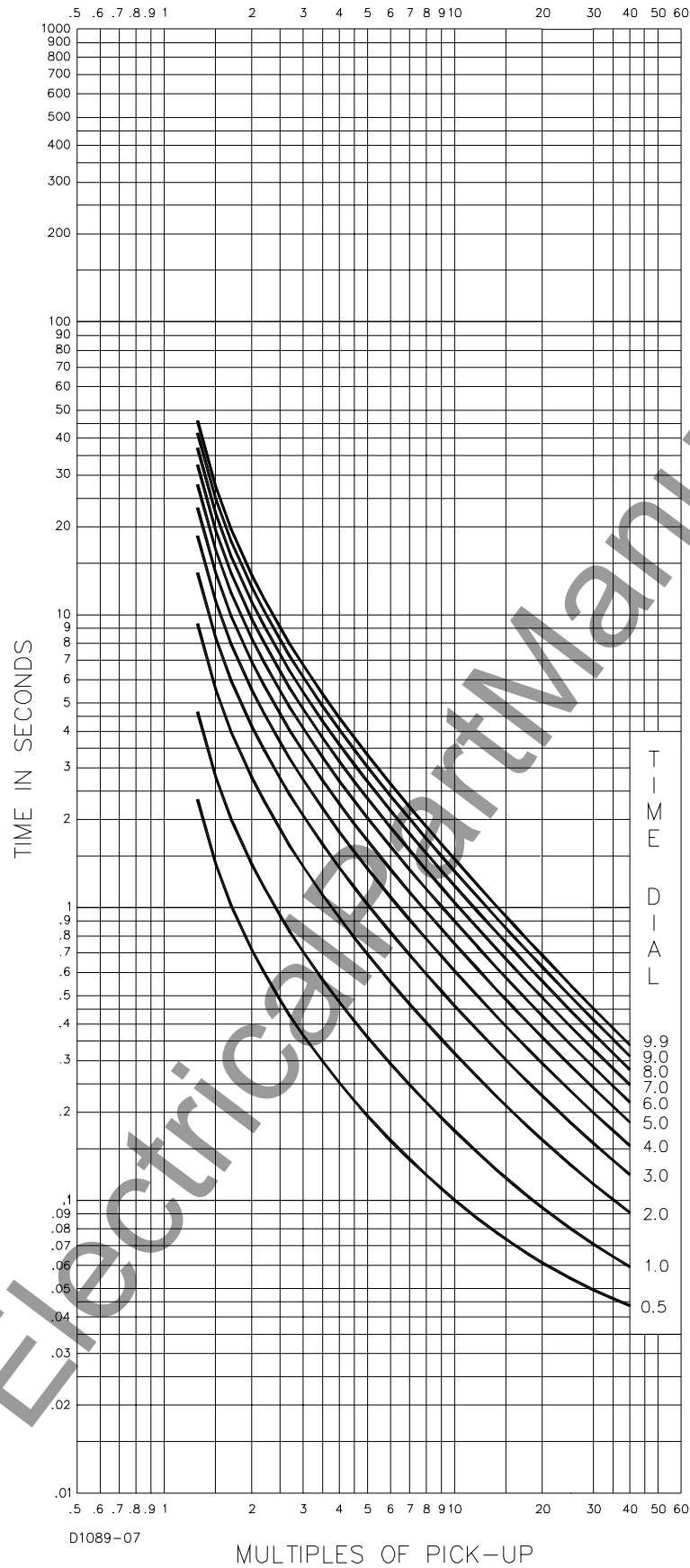

Figure A-8. Time Characteristic Curve, BS142-B
(BS142 Very Inverse)

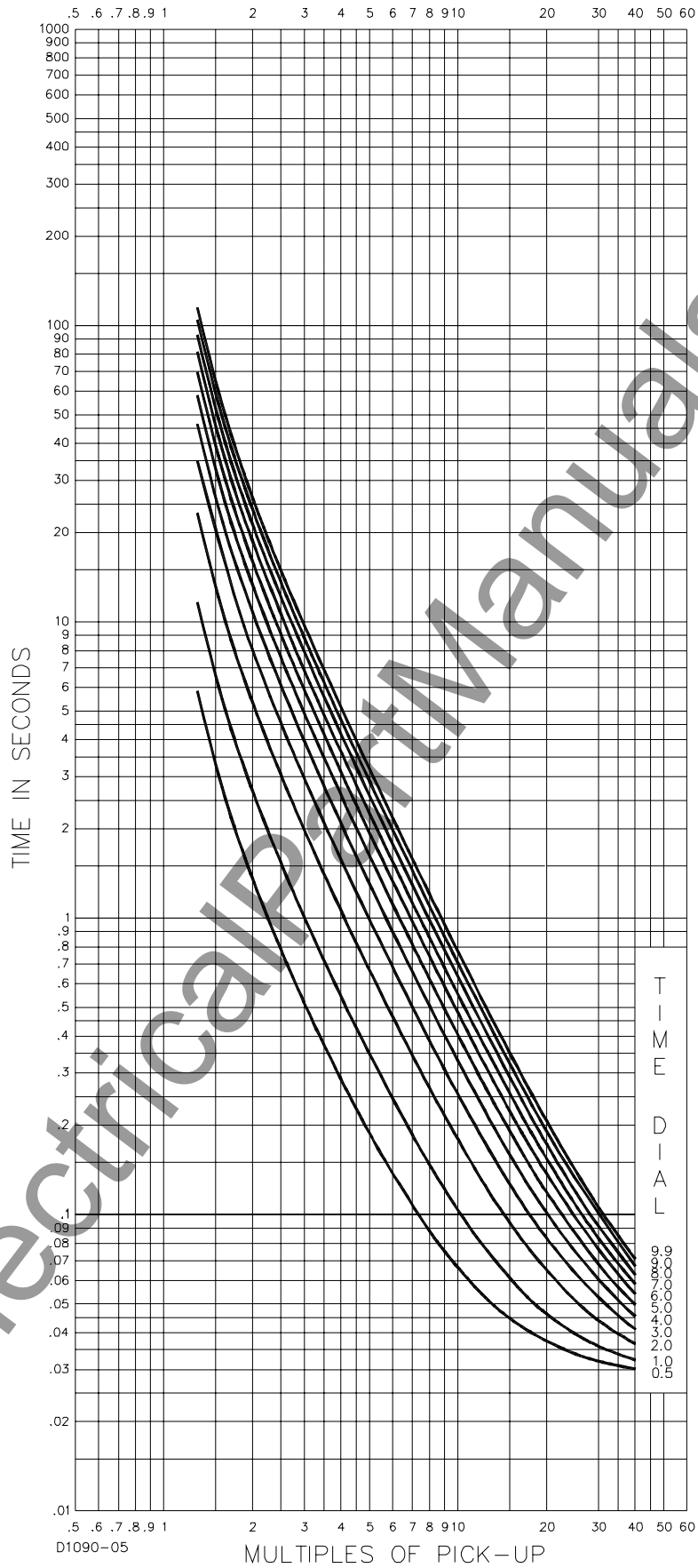

Figure A-9. Time Characteristic Curve, BS142-C
(BS142 Extremely Inverse)

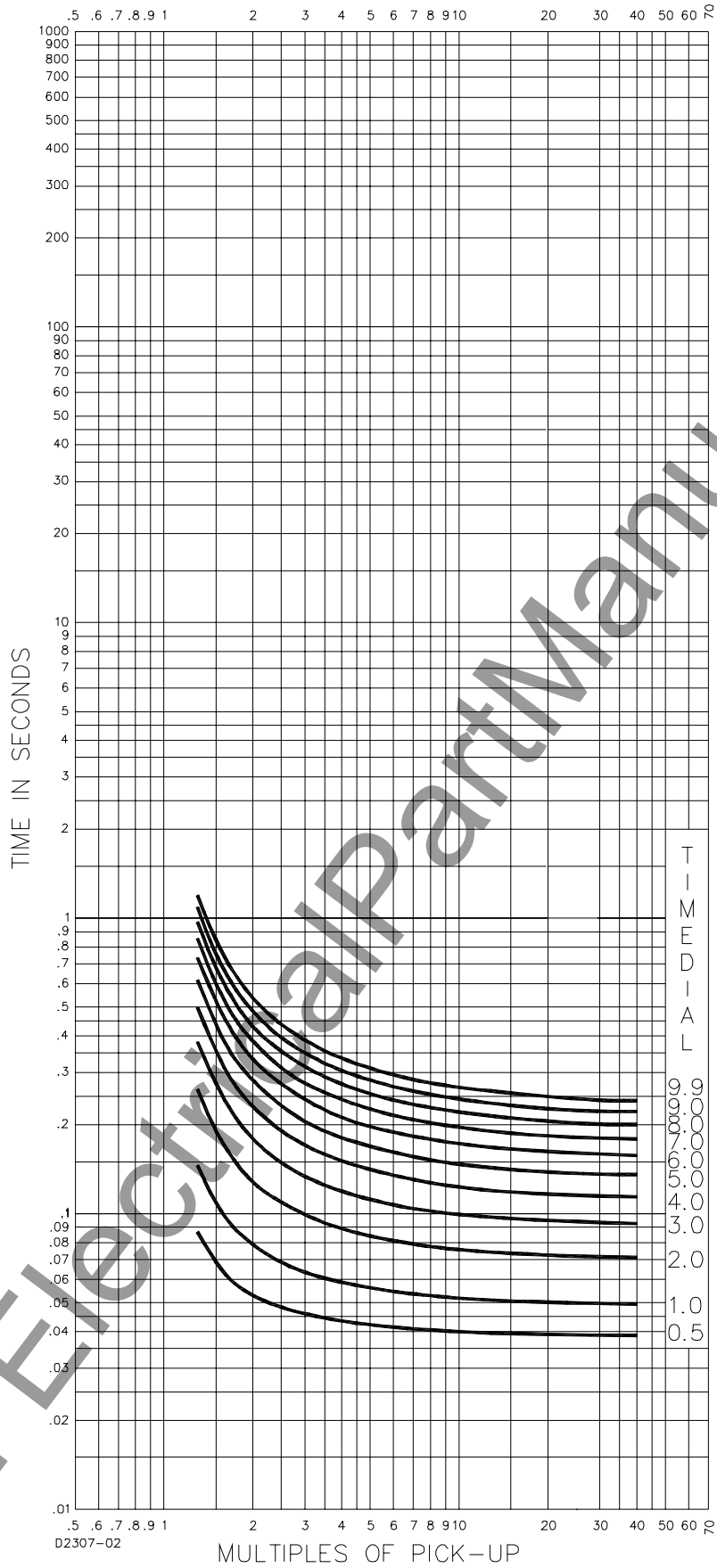

Figure A-10. Time Characteristic Curve, S2-Short Inverse
(SW3-3 ON, Similar to GE IAC 55)

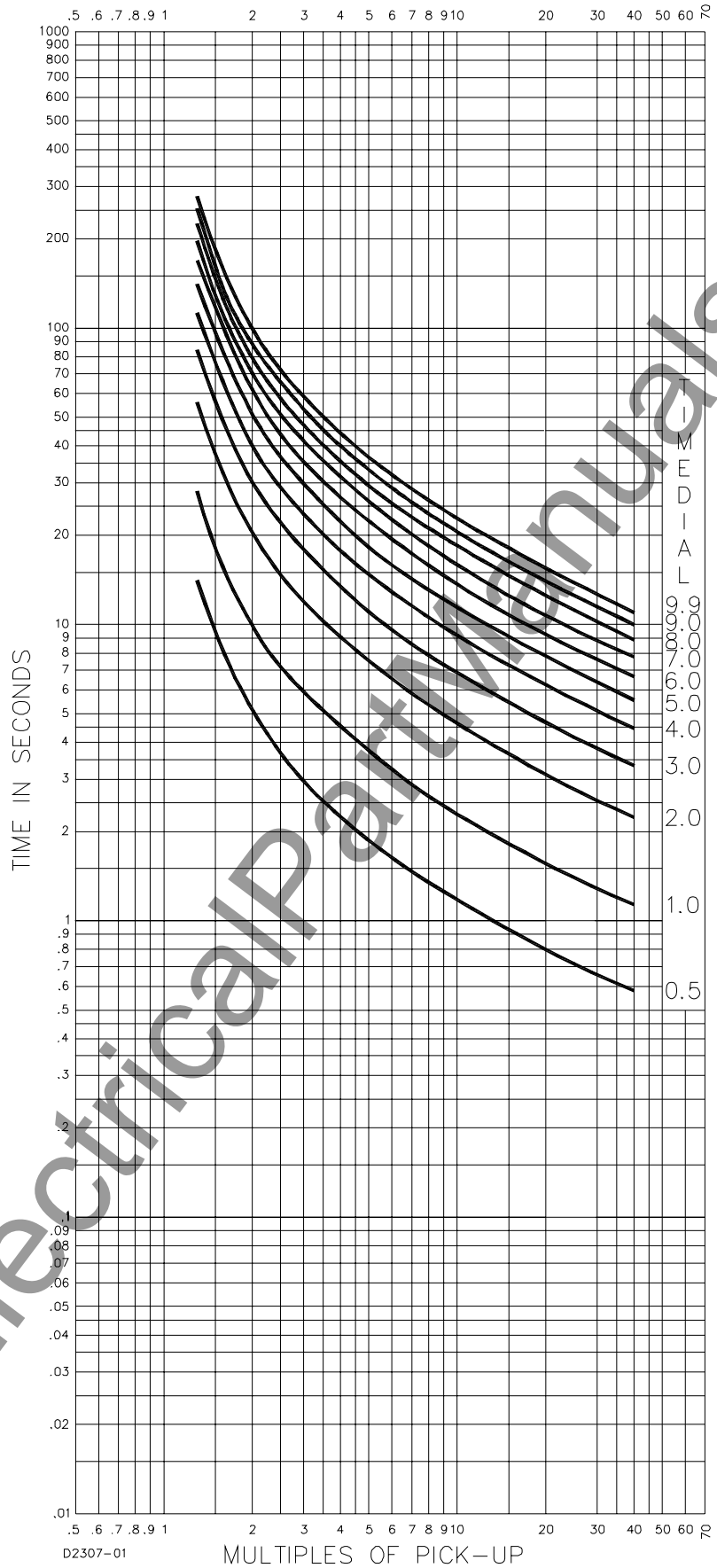

Figure A-11. Time Characteristic Curve, L2-Long Inverse (SW3-3 ON, Similar to GE IAC 66)

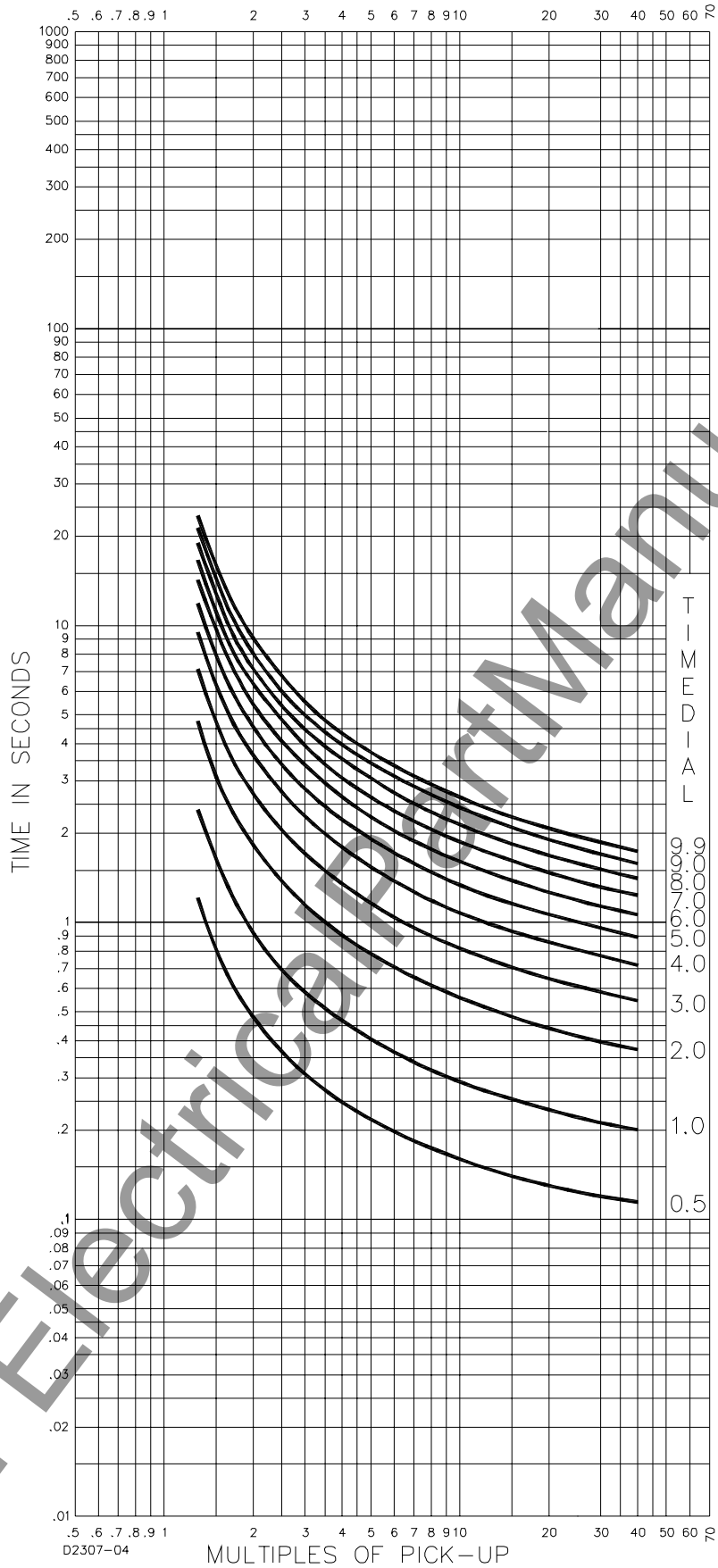

Figure A-12. Time Characteristic Curve, I₂-Inverse
(SW3-3 ON, Similar to GE IAC 51)

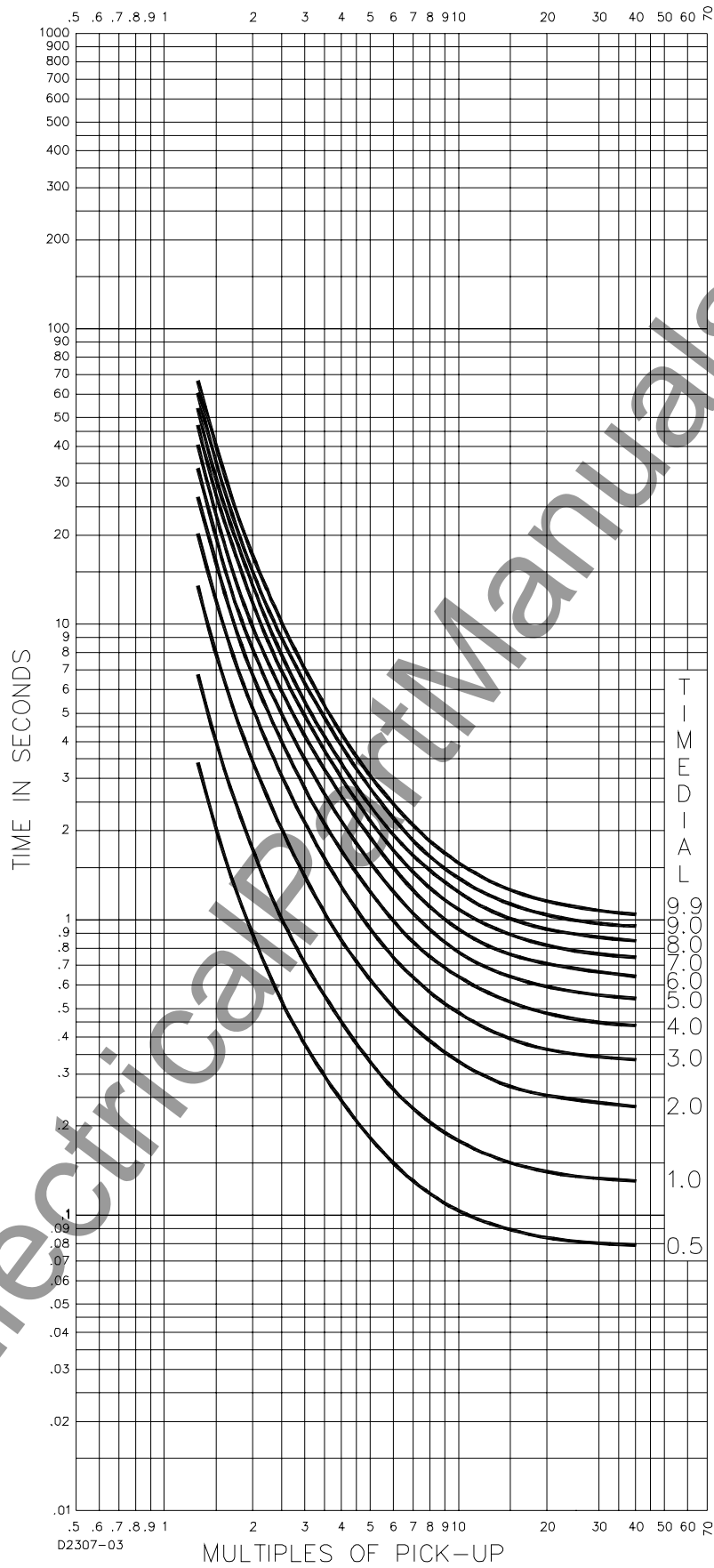

Figure A-13. Time Characteristic Curve, V2-Very Inverse (SW3-3 ON, Similar to GE IAC 53)

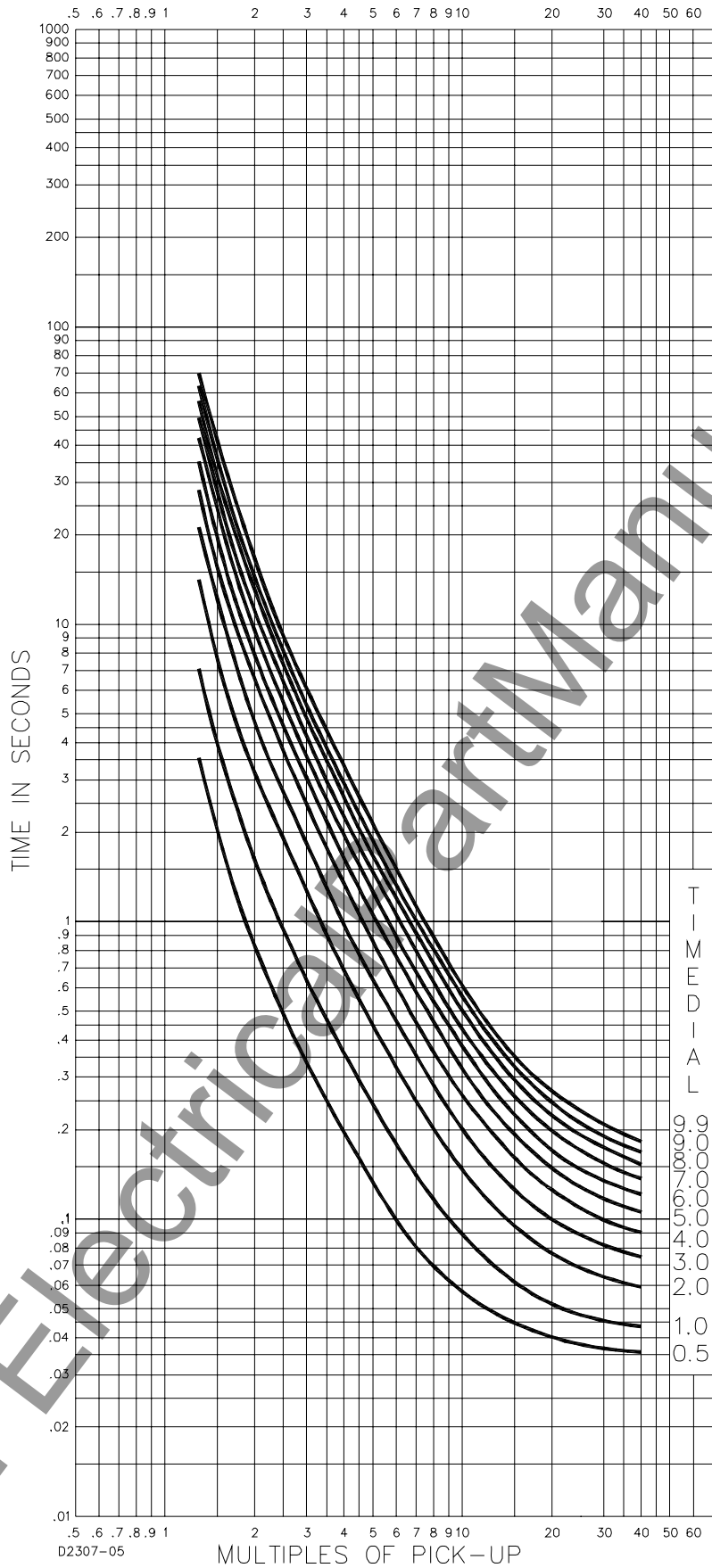

Figure A-14. Time Characteristic Curve, E2-Extremely Inverse (SW3-3 ON, Similar to GE IAC 77)

www.ElectricalPartManuals.com



Basler Electric

ROUTE 143, BOX 269

HIGHLAND, IL 62249 USA

<http://www.basler.com>, info@basler.com

PHONE +1 618-654-2341

FAX +1 618-654-2351