



# INSTRUCTIONS

GEI-68749B  
Supersedes GEI-68749A

MULTI-CONTACT AUXILIARY RELAYS

TYPES

HFA65D AND HFA65E

---

GENERAL  ELECTRIC

CONTENTS

	<u>PAGE</u>
DESCRIPTION.....	3
APPLICATION.....	3
CONSTRUCTION.....	3
RECEIVING, HANDLING AND STORAGE.....	3
ACCEPTANCE.....	4
RATINGS.....	4
CHARACTERISTICS.....	4
BURDENS.....	5
INSTALLATION.....	5
PERIODIC CHECKS AND ROUTINE MAINTENANCE.....	5
CONTACT CLEANING.....	5
SERVICING AND ADJUSTMENTS.....	5
CONTACTS.....	5
PICKUP AND DROPOUT (HFA65D).....	5
PICKUP AND DROPOUT (HFA65E).....	6
RENEWAL PARTS.....	6

## MULTI-CONTACT AUXILIARY RELAYS

## HFA65D AND HFA65E

DESCRIPTION

The Type HFA65D and HFA65E relays are hinged-armature, self-reset auxiliary relays with time delay on dropout. They include six electrically separate contact circuits which can be arranged for either circuit opening or circuit closing operation. The internal connection diagram for HFA65 relays is shown in Fig. 5. External connections for HFA65 relays designed for AC operation are shown by Fig. 6.

The relays are available for either front or back connection. The front connected relays are suitable for surface mounting only, while the back connected relays are available for either surface or semi-flush mounting.

APPLICATION

The Type HFA65D and HFA65E relays are designed for application where a number of circuits must be controlled by the operation of a single auxiliary relay, and where it is necessary to maintain these circuits for a short time after the auxiliary relay is de-energized. The available ranges of time delay as well as the contact arrangement are covered by the section on CHARACTERISTICS.

CONSTRUCTION

The HFA65D and HFA65E relays are available for front or back connection. The front connected relays are suitable for surface mounting only.

The back connected relays are suitable for either surface mounting or semi-flush mounting; a steel flange is necessary for the latter. There are two types of flanges available: one provides mounting with normal cover; one provides mounting with the drawout-case type cover. The different constructions are shown in Figs. 1 thru 4.

The outline dimensions and panel drilling are shown in Figs. 7 thru 10.

Outline of the external rectifier used with HFA65 relays designed for AC operation is shown by Fig. 11.

RECEIVING, HANDLING AND STORAGE

These relays, when not included as a part of a control panel, will be shipped in cartons designed to protect them against damage. Immediately upon receipt of a relay, examine it for any damage sustained in transit. Check that the nameplate rating and model number agree with the requisition. If injury or damage resulting from rough handling is evident, file a damage claim at once with the transportation company and promptly notify the nearest General Electric Apparatus Sales Office.

Reasonable care should be exercised in unpacking the relay in order that none of the parts are injured or the adjustments disturbed.

If the relays are not to be installed immediately, they should be stored in their original cartons in a place that is free from moisture, dust and metallic chips. Foreign matter collected on the outside of the case may find its way inside when the cover is removed and cause trouble in the operation of the relay.

*These instructions do not purport to cover all details or variations in equipment nor to provide for every possible contingency to be met in connection with installation, operation or maintenance. Should further information be desired or should particular problems arise which are not covered sufficiently for the purchaser's purposes, the matter should be referred to the General Electric Company.*

*To the extent required the products described herein meet applicable ANSI, IEEE and NEMA standards; but no such assurance is given with respect to local codes and ordinances because they vary greatly.*

ACCEPTANCE

Check the relays for mechanical damage. Operate the relays by hand to assure that the armature moves freely and that contacts make and wipe properly (see section on SERVICING AND ADJUSTMENTS).

Check pickup voltage and pickup and dropout times as applicable for the relay model (see sections on CHARACTERISTICS and SERVICING AND ADJUSTMENTS).

RATINGS

The HFA65 relays are available with continuous coil ratings of up to 250 volts DC and 115 and 230 volts AC.

The HFA65 relays available for AC operation require an external rectifier and therefore may be used for any frequency from 25 to 5000 cycles.

The current-closing rating of each contact is 30 amperes. The current-carrying rating is 12 amperes continuous or 30 amperes for one minute. Table I lists the non-inductive interrupting capacity of each contact.

TABLE I

DC		AC	
Volts	Amperes	Volts	Amperes
12	30	115	30
24	15	230	20
32	10	460	15
48	8	575	10
125	3		
250	1		

CHARACTERISTICS

The HFA65D relay has an instantaneous pickup time and an adjustable time-delay dropout of 0.25 to 2.0 seconds. If the requisition does not specify a dropout time for the HFA65D, the time delay will be set at the factory for two (2) seconds at rated voltage.

The HFA65E relay has an adjustable pickup time of 0.067 to 0.100 second and a fixed dropout time delay of 0.25 second. If no pickup time is specified for the HFA65E, it will be set for 0.083 seconds at rated voltage.

Unless the relays are ordered with a specific contact arrangement, they will be shipped with six circuit closing contacts (Code 60). The contact arrangement can be easily changed to provide any of the combinations shown in Table II.

TABLE II

Contact Code No.	60	51	42	33	24	15	06
Position No.	Contact Arrangement						
1	a	a	a	a	a	a	b
2	a	a	a	a	b	b	b
3	a	a	b	b	b	b	b
4	a	b	b	b	b	b	b
5	a	a	a	b	b	b	b
6	a	a	a	a	a	b	b

a = Normally Open  
 b = Normally Closed

BURDENS

The burden of the DC relays is approximately 13 watts when cold and 10 watts when hot. The burden of the AC relays, including rectifiers, is approximately 30 volt-amperes and 20 watts.

INSTALLATION

The Type HFA relays should be mounted on a vertical surface. The outline and panel drilling diagrams are shown in Figs. 7 to 10. Surface mounting on steel panels requires an insulating bushing for each terminal.

The internal connections diagram is shown in Fig. 5. The external wiring diagram of the AC relays with rectifiers is shown in Fig. 6. It should be noted that the contact which de-energizes the relay coil must be connected on the AC side of the rectifier. The external rectifier outline is shown in Fig. 11.

PERIODIC CHECKS AND ROUTINE MAINTENANCE

In view of the vital role of protective relays in the operation of a power system it is important that a periodic test program be followed. It is recognized that the interval between periodic checks will vary depending upon environment, type of relay and the user's experience with periodic testing. Until the user has accumulated enough experience to select the test interval best suited to his individual requirements it is suggested that the points listed under ACCEPTANCE be checked on the same schedule as the associated protective relays.

CONTACT CLEANING

For cleaning relay contacts, a flexible burnishing tool should be used. This consists of a flexible strip of metal with an etched-roughened surface resembling in effect a superfine file. The polishing action is so delicate that no scratches are left, yet it will clean off any corrosion thoroughly and rapidly. Its flexibility insures the cleaning of the actual points of contact. Do not use knives, files, abrasive paper or cloth of any kind to clean relay contacts.

The burnishing tool described is included in the standard XRT11A relay tool kit obtainable from the factory.

SERVICING AND ADJUSTMENTS

These relays have been calibrated at the factory and under normal conditions no further calibration adjustments are necessary. The relay contacts should not require readjustment since they are self aligning. However, if recalibration or readjustment is required for any reason, the following instructions should be followed:

CONTACTS

Any contact circuit can be changed from circuit opening to circuit closing, or vice versa, by removing the fixed contact, turning it over and replacing it. (See Table II.) After the change, the contacts should be checked to see that all circuit closing contacts make simultaneously when the relay is operated by hand, and that all circuit opening contacts reclose simultaneously when the relay is allowed to drop out. All moving contacts should have at least 3/64 inch wiper when in their operated positions. It may be necessary to bend the moving contact arms to realize these requirements.

PICKUP AND DROPOUT (HFA65D)

The HFA65D relays designed for AC operation pickup between 35 percent and 80 percent of rated voltage. The HFA65D relays designed for DC operation pickup between 30 percent and 60 percent of rated voltage.

Since the values of time-delay dropout and voltage pickup cannot be adjusted independently, it is necessary to make the time-delay adjustment first and then check that the pickup value falls within approximate limits.

To obtain a particular dropout time, the following procedure is necessary:

1. Set control spring for maximum tension by turning the knurled adjusting nut clockwise. Reseat the nut in hexagonal groove in the armature tail piece.

2. Adjust the residual screw to obtain the required time delay. The relay dropout time is measured from the time the coil is de-energized until a normally open contact opens. Turning the screw clockwise decreases the time delay. It is permissible to lessen the control spring tension to obtain the required time delay.

Check the value of voltage at which the relay will pick up and seal in. This pickup voltage may be varied by adjusting the control spring. Any change in the control spring tension requires a recheck on the dropout time as it will be affected.

PICKUP AND DROPOUT (HFA65E)

The pickup and dropout times are to be taken on the normally closed contacts. Code 60 contacts obviously require that all times be measured on a normally open contact. Table III lists the approximate pickup setting required by adjustment of the control spring to obtain the specified pickup times.

TABLE III

P.U. Time at Rated Volts Min. Seconds	P.U. Time at 0.72 X Rated Volts Max. Seconds	Approx. P.U. Voltage Setting
0.067	0.100	0.44 X Rated
0.083	0.135	0.50 X Rated
0.100	0.180	0.58 X Rated

After obtaining the required pickup time, the residual calibrating screw may be adjusted to obtain the 0.25 to 0.30 second dropout time.

RENEWAL PARTS

When ordering renewal parts, address the nearest Sales Office of the General Electric Company, specify quantity required, name of part wanted, and give complete nameplate data. The renewal parts publication is GEF-2757.



FIG. 1 (8025882) HFA65 Back Connected Relay for Surface Mounting (Front View)



FIG. 2 (8025884) HFA65 Front Connected Relay for Surface Mounting (Front View)

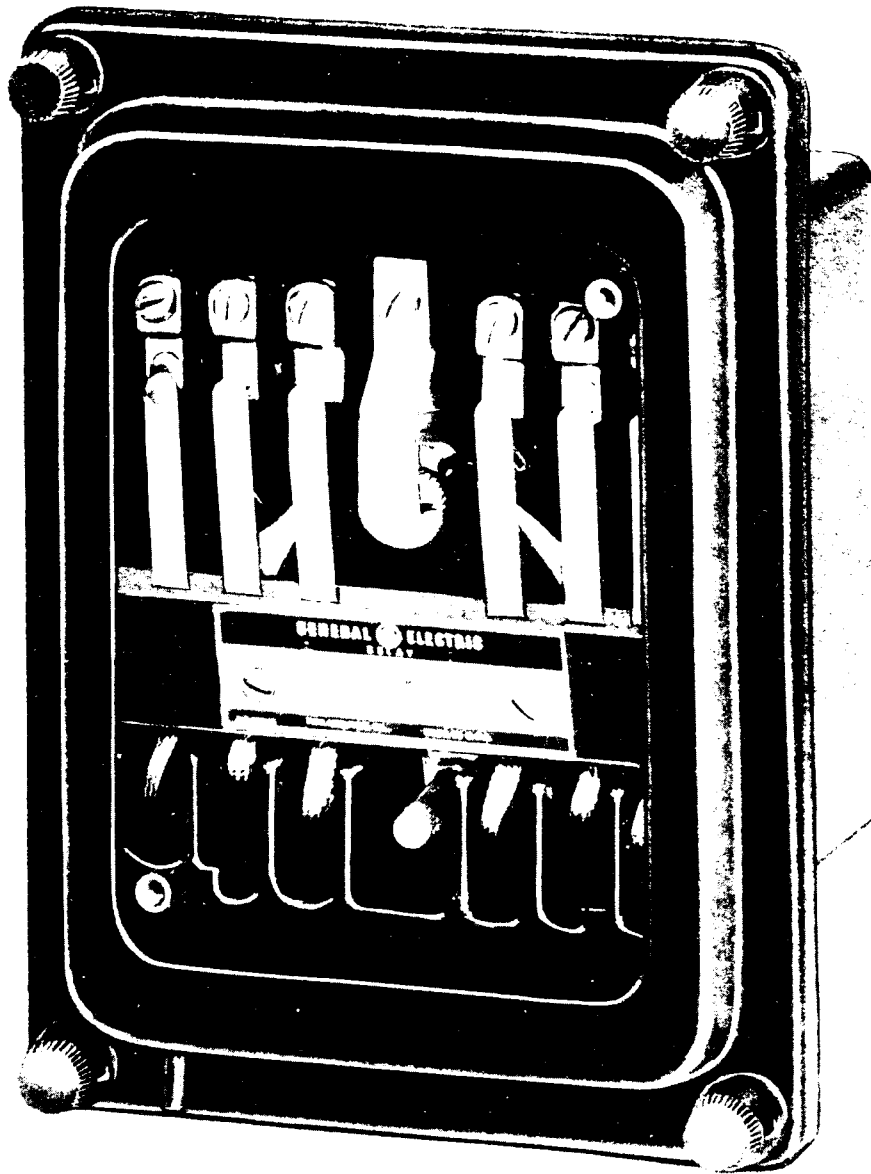

FIG. 3 (8025885) HFA65 Back Connected Relay with Flange for Semi-flush Mounting to Line Up with Cover of Drawout Case (Front View)



FIG. 4 (8025883) HFA65 Back Connected Relay with Flange for Semi-flush Mounting (Front View)

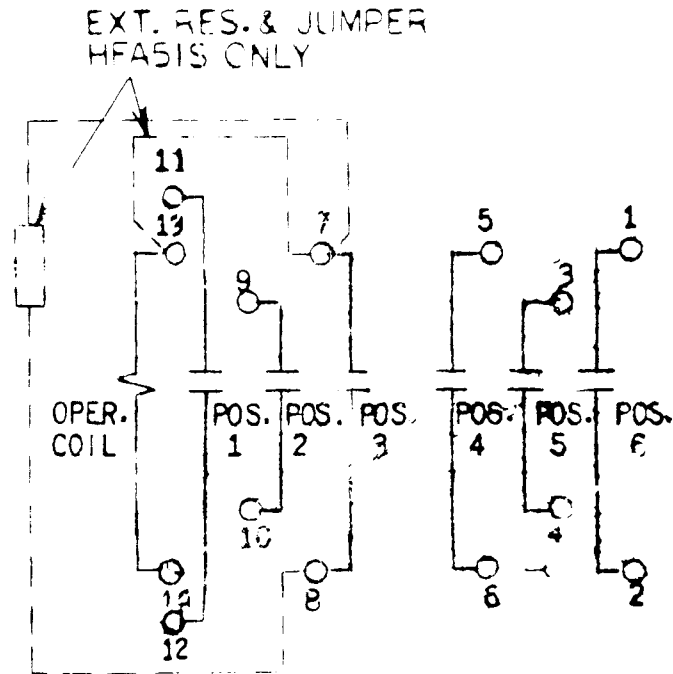

FIG. 5 (104A8526-7) Internal Connection Diagram for HFA65 Relays (Front View)

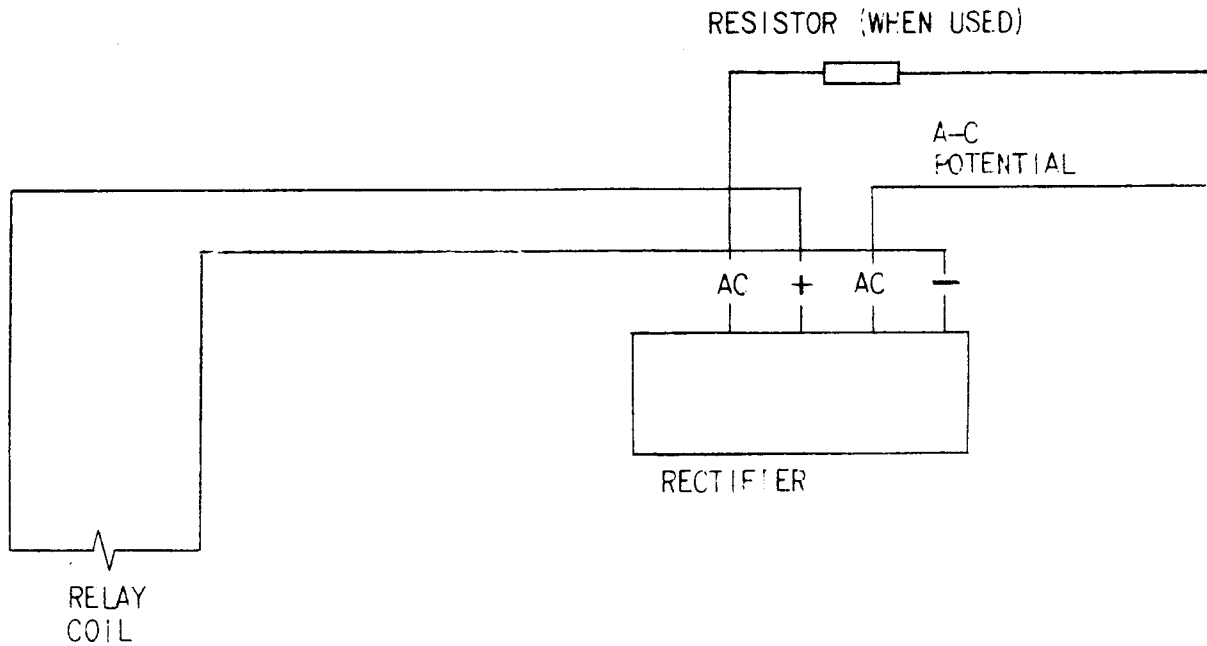

FIG. 6 (418A820-1) External Connections for HFA65 Relays Designed for AC Operation

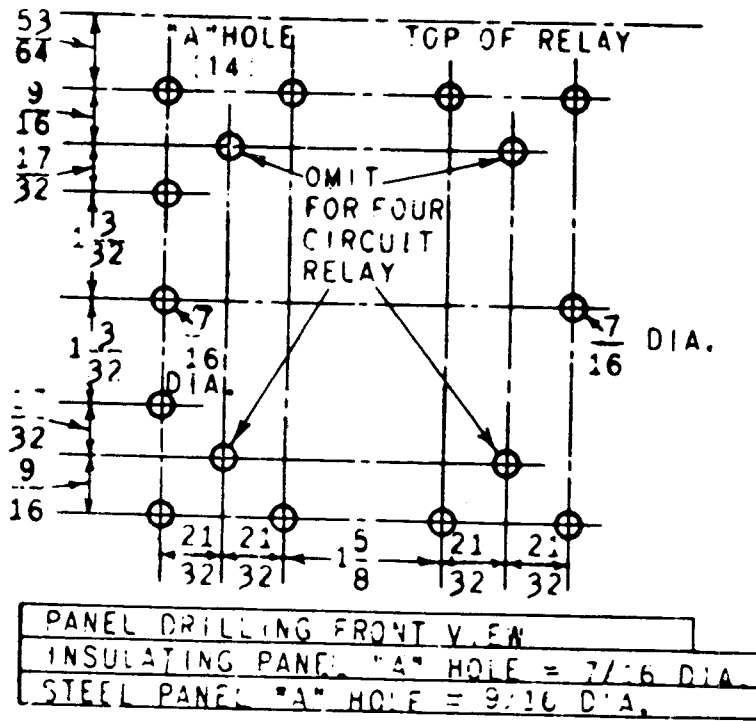
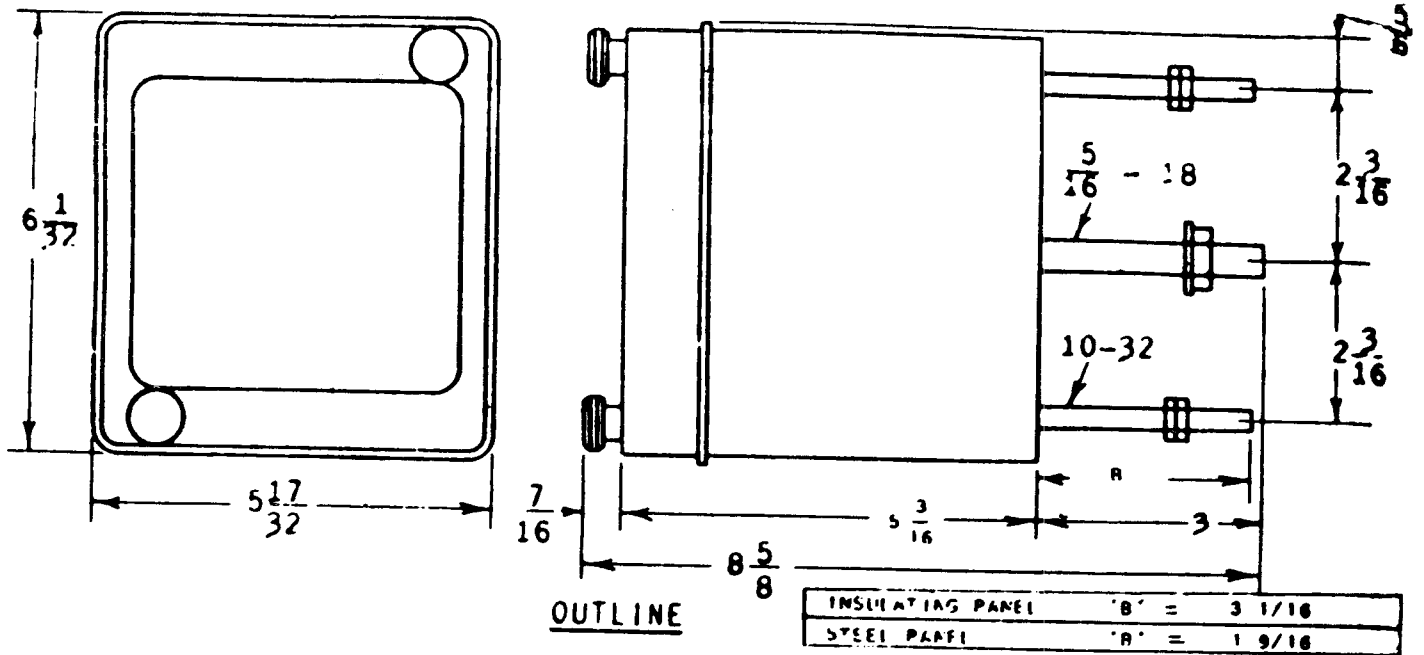

FIG. 7 (6178931-12) Outline and Panel Drilling for Surface Mounted Type HFA Relays (Typical Model Number is HFA65D(-))



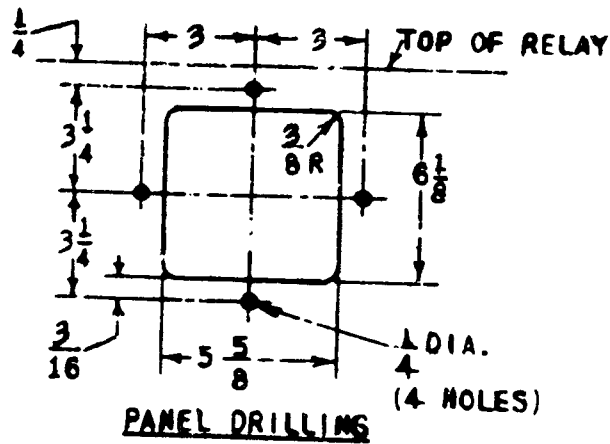
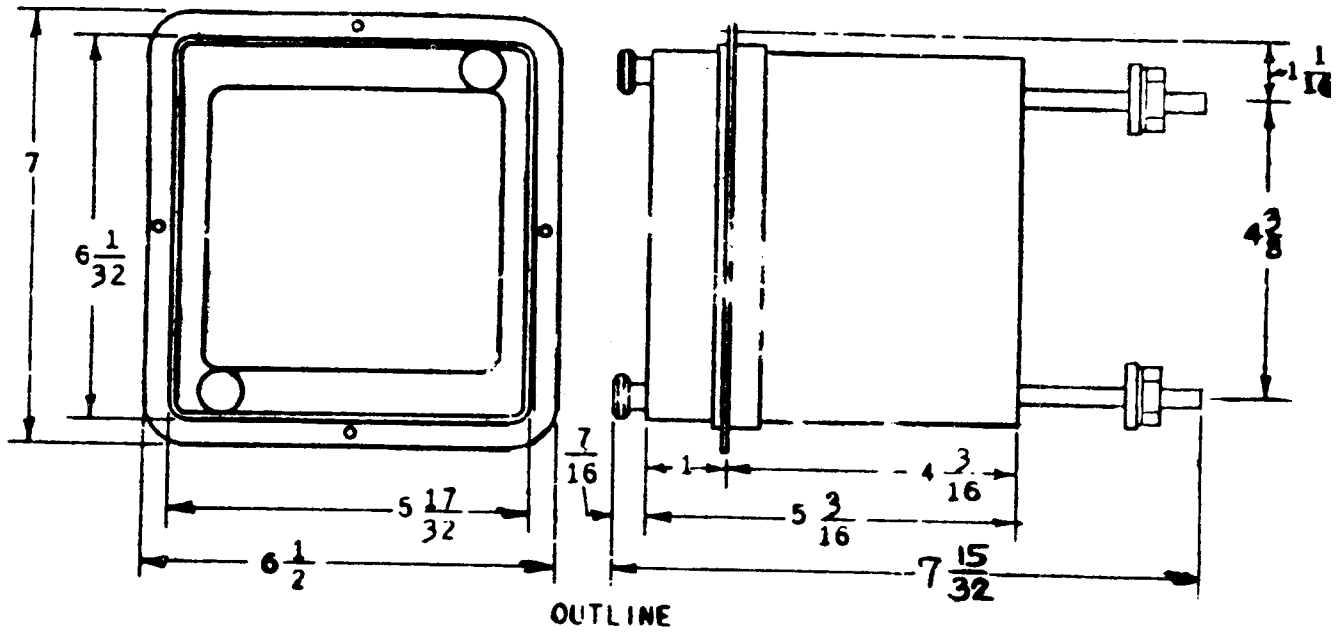

FIG. 9 (6178972-9) Outline and Panel Drilling for Semi-flush Mounted Type HFA Relays  
(Typical Model Number is HFA65D(-)F)

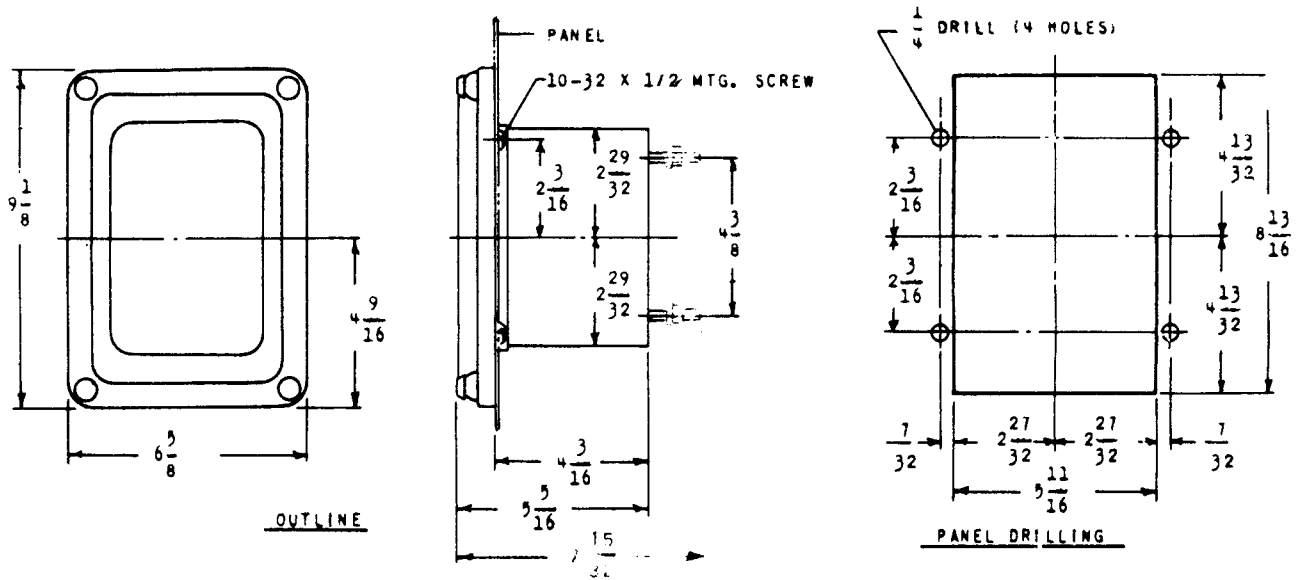

FIG. 10 (K-6375766-5) Outline and Panel Drilling for Semi-flush Mounted Type HFA Relays That Line Up with Drawout Type Cases (Typical Model Number is HFA65D(-)E)

