

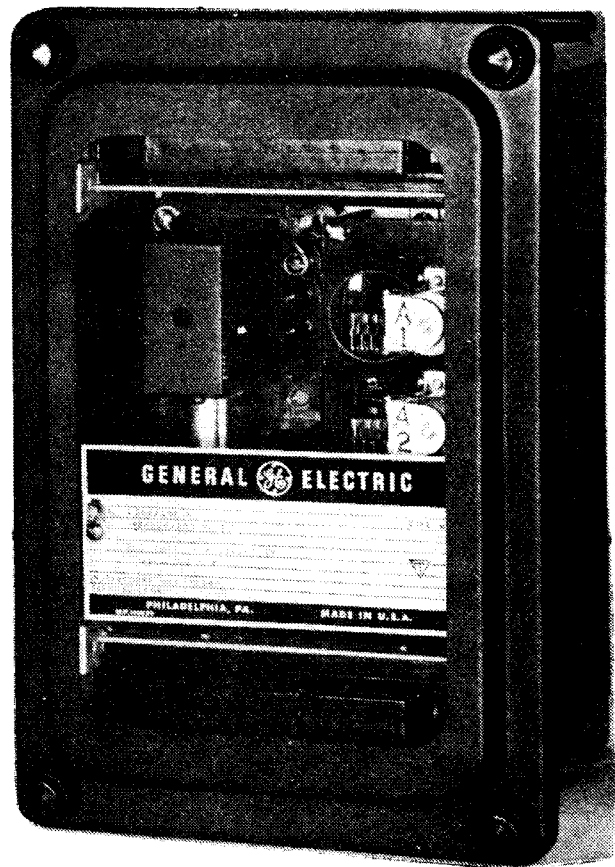

---

**GROUND DISTANCE AUXILIARY  
RELAY**

**Type NAA15E  
NAA15F**



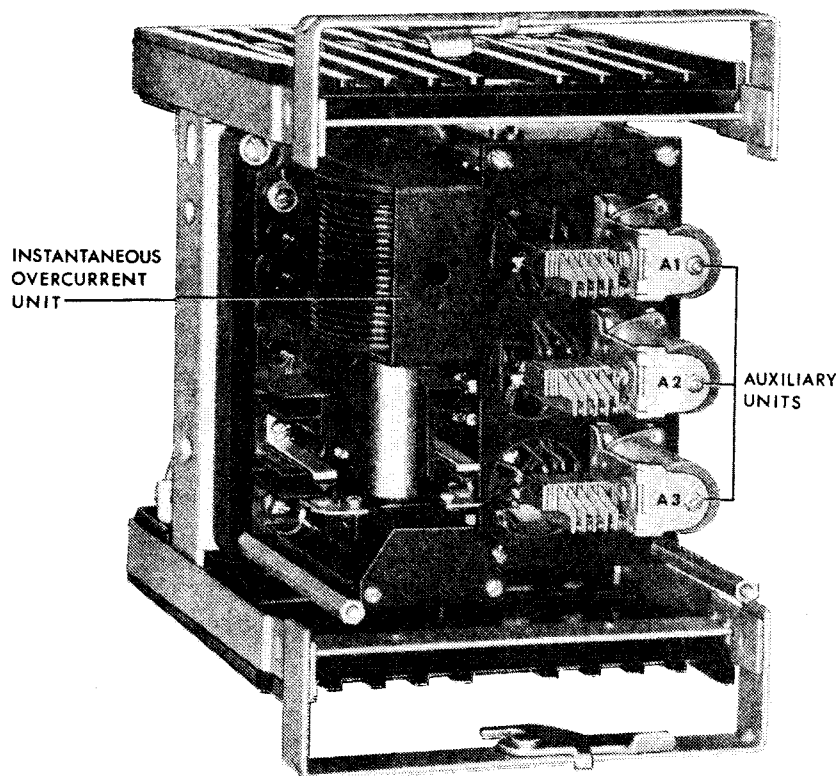

Fig. 1 (8035575) Type NAA15E Relay Removed From Case, Front View.

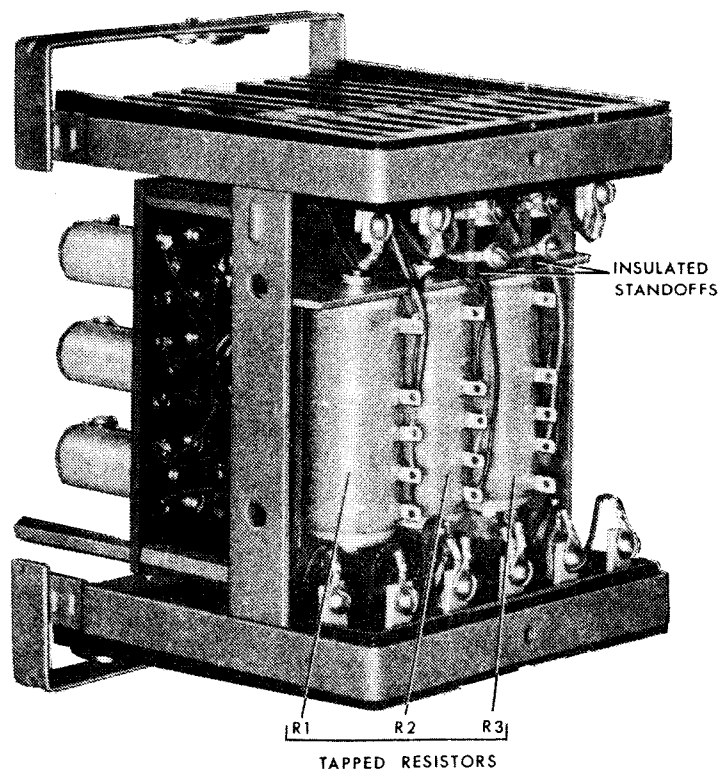

Fig. 2 (8035578) Type NAA15E Relay Removed From Case, Rear View.

# GROUND DISTANCE AUXILIARY RELAY

## TYPE NAA15E

### INTRODUCTION

The NAA15E is a special purpose relay specifically designed for use with ground distance relays of the GCXG51 type. Instruction book GEI-98339 for the GCXG relay covers this application in detail.

The NAA15E relay contains a plunger-type instantaneous overcurrent unit plus three telephone type auxiliary units as shown in the internal connection diagram of Fig. 5. The relay comes in an S2 case and one NAA15E is required with each set of three GCXG51 relays, suitable RPM or SAM timing relay, and auxiliary CT to comprise a complete terminal of three-step ground distance protection.

### APPLICATION

The NAA15E relay was specifically designed to be applied in ground step distance protective schemes in conjunction with GCXG51 ground distance relays. In this application the three auxiliary units and the plunger-type overcurrent unit are interlocked with the mho units of the GCXG relays to permit first and second zone tripping for single-phase-to-ground faults only.

The overcurrent unit is connected in the CT neutral circuit to receive  $3I_0$  and it must be set with a pick-up that is low enough to insure operation on all ground faults for which the ground relays are desired to operate. For best overall results the minimum fault current should be at least 1.5 times the pick-up setting of the overcurrent unit.

### RATINGS

The NAA15E relays covered by these instructions have a D-C voltage rating of 48/125/250 volts determined by relay connections. Selection of the rating for a specific application is discussed in the section on INSTALLATION PROCEDURE.

The relays can be furnished with instantaneous overcurrent units having AC ratings and calibration ranges as shown in Table I. The overcurrent units are suitable for operation on either 50 or 60 cycles, but are not rated for continuous operation in the picked-up position.

The NAA15F relay is similar to the NAA15E relay except with a mechanical target on the PJC unit and a reset rod.

TABLE I

RATING	CALIBRATION RANGE
6A	2-8A
3	1-4
1.5	0.5-2

The contacts of the auxiliary units and the instantaneous overcurrent unit will make and carry momentarily 30 amperes DC at control voltages of 250 volts or less. These contacts will carry 3 amperes continuously and have an inductive interrupting rating as shown in Table II.

TABLE II

Interrupting Rating  
"A" Unit Contacts

VOLTS	CURRENT AMPERES
48	1
125	0.5
250	0.25

### CHARACTERISTICS

The auxiliary units A<sub>1</sub>, A<sub>2</sub> and A<sub>3</sub> are adjusted to pick up at less than 70 percent of the nominal DC voltage rating as determined by relay connections.

In the normal application of the relay with the type GCXG ground distance relay, the DC auxiliary units are energized through the contacts of the instantaneous overcurrent unit and the contact of the starting unit in the GCXG relay on the faulted phase.

The operating time of the auxiliary units A<sub>1</sub>, A<sub>2</sub>, and A<sub>3</sub> at rated D-C voltage is listed in Table III for the three ratings.

*These instructions do not purport to cover all details or variations in equipment nor to provide for every possible contingency to be met in connection with installation, operation or maintenance. Should further information be desired or should particular problems arise which are not covered sufficiently for the purchaser's purposes, the matter should be referred to the General Electric Company.*

*To the extent required the products described herein meet applicable ANSI, IEEE and NEMA standards; but no such assurance is given with respect to local codes and ordinances because they vary greatly.*

**TABLE III**  
Operating Time-Units A<sub>1</sub>-A<sub>2</sub>-A<sub>3</sub>

NOMINAL RATING	TIME
48 V.DC	6 M.S.
125	4
250	3

The operating time of the instantaneous overcurrent unit at various multiples of pickup is shown in Fig. 3.

**BURDENS**

The D-C resistance of auxiliary units A<sub>1</sub>, A<sub>2</sub>, and A<sub>3</sub>, and their associated resistors is shown in the tabulation accompanying the internal connection diagram, Fig. 5.

The AC burden of the instantaneous unit is shown in Table IV for the available current ranges. The values in Table IV are with the armature set for minimum pickup and in the dropped-out position.

**TABLE IV**  
Burden Data - Instantaneous Overcurrent Unit

Rated Amps	Cal. Range	Freq.	At 5 Amperes		At Min. Pickup	
			Watts	VA	Watts	VA
6	2-8	60	3.6	11.5	0.6	1.7
3	1-4	60	12.7	41	0.6	1.7
1.5	0.5-2	60	55	165	0.6	1.7

**CONSTRUCTION**

The Type NAA15E relays are assembled in the standard small size, double-end (S2) drawout case having studs at the upper and lower ends in the rear for external connections. The electrical connections between the relay components and the case studs are made through stationary molded inner and outer blocks between which nests a removable connecting plug which completes the circuits. The outer block attached to the case has the studs for the external connections, and the inner block has the terminals for the internal connections.

The relay components are mounted on a steel framework called the cradle forming a complete unit with all leads terminated at the inner block. This cradle is held firmly in the case by latches at both top and bottom and by a guide pin at the back of the case. The connecting plugs, between the respective blocks of the cradle and case, also lock the latches in place. The cover, which is drawn to the case by thumbscrews, holds the connecting plugs in place.

A separate testing plug can be inserted in place of the connecting plug to test the relay in place on the panel either from its own source of voltage, or from other sources. Or the relay can be drawn out and replaced by another which has been tested in the laboratory.

The relay case is suitable for either semi-flush or surface mounting on all panels up to 2 inches thick and appropriate hardware is available. However, panel thickness must be indicated on the relay order to insure that proper hardware will be included. For outline and drilling dimensions, see Fig. 6. Every circuit in the drawout case has an auxiliary brush, as shown in Fig. 4, to provide adequate overlap when the connecting plug is with-

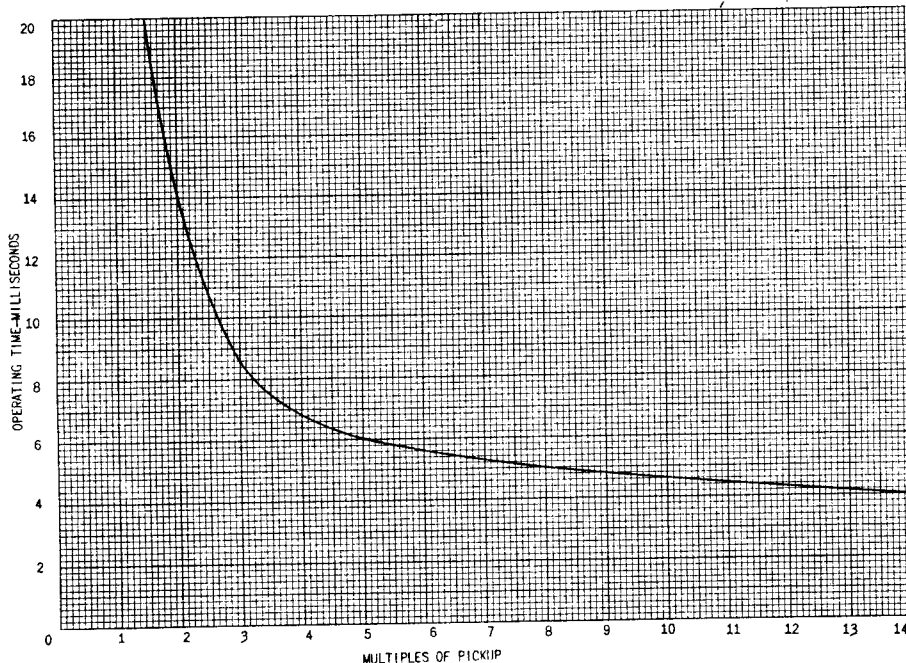
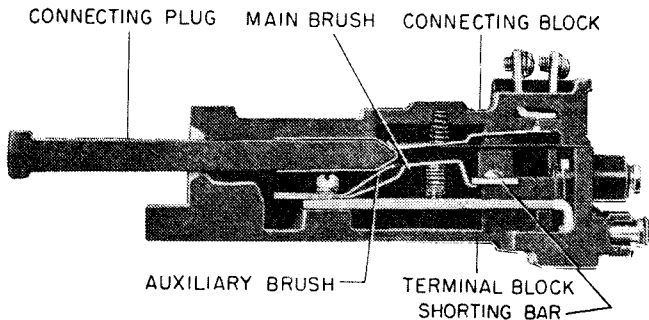

Fig. 3 (0178A9040-0) Time-Current Curve For The Instantaneous Overcurrent Unit.

drawn or inserted. Some circuits are equipped with shorting bars and on these circuits it is especially important that the auxiliary brush makes contact as indicated in Fig. 4 with adequate pressure to prevent the opening of important interlock circuits.



NOTE: AFTER ENGAGING AUXILIARY BRUSH, CONNECTING PLUG TRAVELS 1/4 INCH BEFORE ENGAGING THE MAIN BRUSH ON THE TERMINAL BLOCK

Fig. 4 (8025039) Cross Section Of Case And Cradle Block Showing Auxiliary Brush And Shorting Bar.

The Cradle assembly includes the three auxiliary telephone-type units A<sub>1</sub>, A<sub>2</sub>, and A<sub>3</sub> with associated tapped resistors R<sub>1</sub>, R<sub>2</sub>, and R<sub>3</sub>, and the instantaneous overcurrent unit (IOC). The location of these components is indicated in Figs. 1 and 2. Component designations agree with the designations on the internal connection Diagram, Fig. 5.

#### RECEIVING, HANDLING AND STORAGE

These relays, when not included as part of a control panel, will be shipped in cartons designed to protect them against damage. Immediately upon receipt of a relay, examine it for any damage sustained in transit. If injury or damage resulting from rough handling is evident, file a damage claim at once with the transportation company and promptly notify the nearest General Electric Apparatus Sales Office.

Reasonable care should be exercised in unpacking the relay. If the relays are not to be installed immediately, they should be stored in their original cartons in a place that is free from moisture, dust and metallic chips. Foreign matter collected on the outside of the case may find its way inside when the cover is removed and cause trouble in the operation of the relay.

#### ACCEPTANCE TESTS

Immediately upon receipt of the relay an INSPECTION AND ACCEPTANCE TEST should be made to insure that no damage has been sustained in shipment and that the relay calibrations have not been disturbed. If the examination or test indicates that readjustment is necessary, refer to the section on SERVICING.

#### Visual Inspection

Check the nameplate stamping to insure that

the model number and rating of the relay agree with the requisition.

Remove the relay from its case and check that there are no broken or cracked molded parts or other signs of physical damage.

#### Mechanical Inspection

It is recommended that the following mechanical adjustments be checked.

1. Operate each auxiliary telephone-type unit A<sub>1</sub>, A<sub>2</sub>, & A<sub>3</sub> manually to be sure the armatures are moving freely. With the armature closed the normally closed contacts should make with approximately .005" wiper. This can be checked by inserting a .005" shim between the residual screw and the pole piece and operating the armature by hand. The N.O. contacts should make before the residual screw strikes the shim.

With the armature open each normally open contact should have a gap of .010" to .015".

2. Operate the plunger of the overcurrent unit by hand and allow it to reset to be sure that it is free from friction or binds.

The wiper on the two normally open contacts should be approximately 3/32 inch. The contact gap with the armature fully reset should be approximately 1/16 inch. There are backstops above both normally open contacts. The gap between the backstop and contact brush at the tip should be approximately 3/32 inch with the armature reset. At the point of maximum armature travel the contact brush should just strike the backstop and deflect it approximately .005".

3. Check the location of the contact brushes on the cradle and case blocks against the internal connection diagram in Fig. 5. Be sure the short and long brushes, and the shorting bar on the case blocks are in the positions shown in Fig. 5.

#### Electrical Tests

It is recommended that the following electrical checks be made immediately upon receipt of the relay. Note that the tests should be made with the relay in its case and in a level position.

1. Auxiliary Units - The circuits of the auxiliary units A<sub>1</sub>, A<sub>2</sub>, and A<sub>3</sub> are designed so that the units can be operated on 48, 125 or 250 volts D-C depending upon external connections to the relay or on the arrangement of the leads connected to terminals 14, 15 and 16. It is recommended that the auxiliary units be checked for operation at each nominal voltage rating by connecting an adjustable source of DC voltage between the studs shown in Table V being sure to observe polarity. Note that the 48 volt circuits, identified by green insulation, are normally connected to insulated standoffs (14A, 15A, or 16A) when the relay is shipped

Ground Distance Auxiliary Relay Type NAA15E GEI-98340

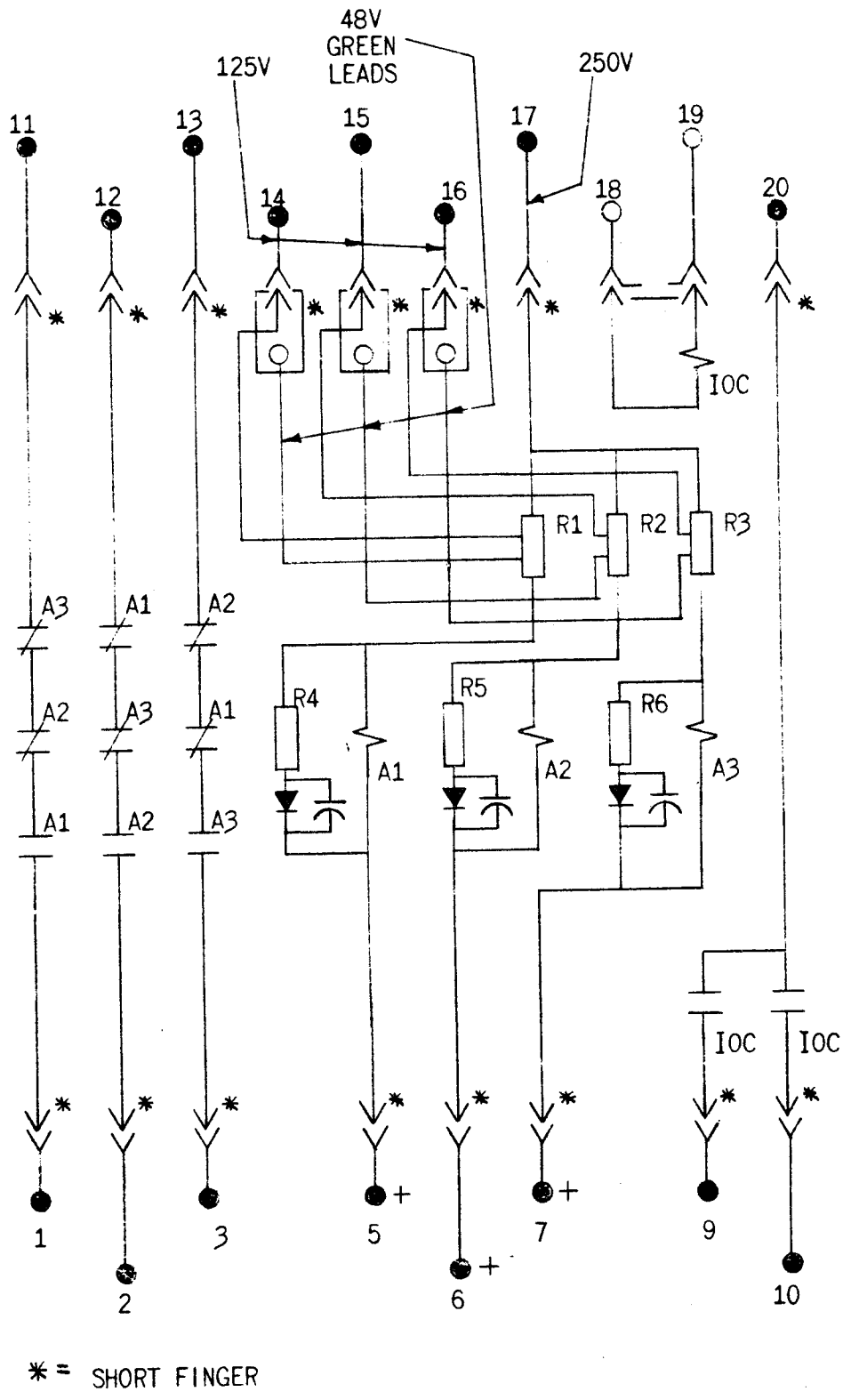

\* Fig. 5 (0178A8168 Sh.1 [2] and Sh.2 and Table of Rating

12NAA15F(-)A

MODEL	RATED	R1-R2-R3 TAPS						R4-R5-R6	A1-A2-A3 COILS	SUPERCEDED BY FORMS
		24V	48V	125V	250V	110V	220V			
12NAA15F1A	48/125/250		500	1500	3000			560	58	5
2A	48/125/250		500	1500	3000			560	58	6
3A	48/125/250		500	1500	3000			560	58	7
4A										
5A *	48/125/250	—	500	1500	3000	—	—	560	58	
6A *	48/125/250	—	500	1500	3000	—	—	560	58	
7A *	48/125/250	—	500	1500	3000	—	—	560	58	
8A *	24/48/125	60	500	1500	—	—	—	560	58	
9A *	48/110/220	—	500	—	—	1300	2600	560	58	

12NAA15F(-)A

MODEL	RATED	R1-R2-R3 TAPS			A1-A2-A3 COILS	R4-R5-R6	SUPERCEDED BY FORMS
		48V	125V	250V			
12NAA15F1A	48/125/250	500	1500	3000	58	560	5
2A	48/125/250	500	1500	3000	58	560	6
3A	48/125/250	500	1500	3000	58	560	7
4A							
5A *	48/125/250	500	1500	3000	58	560	
6A *	48/125/250	500	1500	3000	58	560	
7A *	48/125/250	500	1500	3000	58	560	

\* SURGE CAPACITORS ADDED ACROSS DIODES

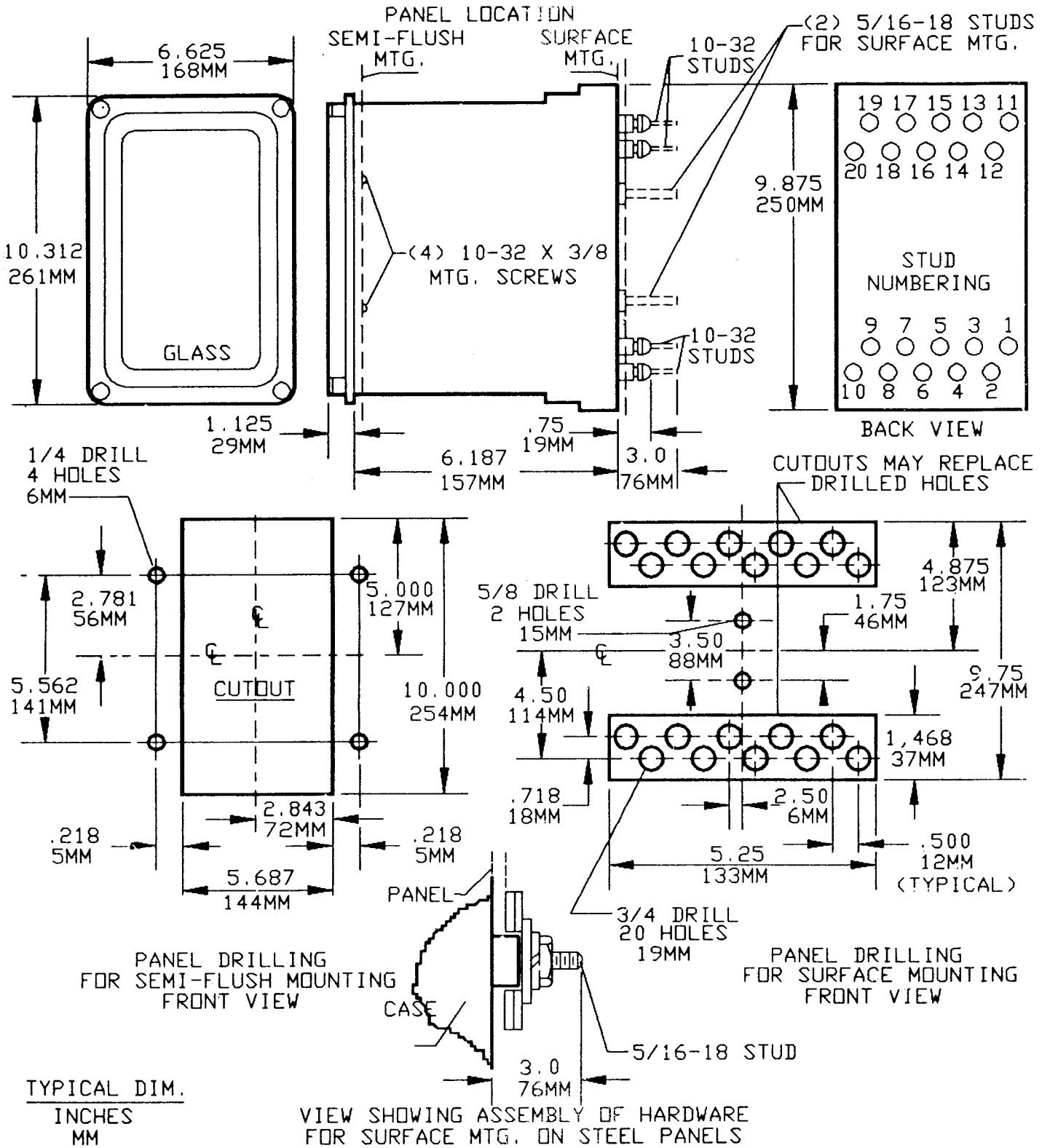

\* Fig. 6 (006209274 161) Outline and Panel Drilling Dimensions for Relays Type NAA15E and NAA15F.

from the factory. To check the operation of the auxiliary units with the 48-volt connection, interchange the red and green leads on terminals 14, 15 and 16. For each connection shown in Table V the auxiliary units should pick up at less than 70 percent of the nominal voltage rating.

Unless the relay is to be used with 48 volts DC control voltage, after the tests have been completed the connections on terminals 14, 15, and 16 should be restored so that the green leads are connected to the insulated standoffs and the red leads to terminals 14, 15, or 16.

TABLE V

Unit	Conn. (+) To Stud	Conn. (-) To Stud:		
		Low V	Med V	Hi V
A <sub>1</sub>	5	14A	14	17
A <sub>2</sub>	6	15A	15	17
A <sub>3</sub>	7	16A	16	17

2. Overcurrent Unit - As shipped from the factory the overcurrent unit is normally set for the minimum pickup point, that is with the bottom edge of the armature aligned with the top mark on the calibration tube. It should be sufficient to check the pickup of the overcurrent unit at this minimum setting.

Connect an adjustable source of A-C current in series with the IOC coil (studs 18-19). With gradually increasing test current the unit should pick up, closing its normally open contacts (studs 9-20 and 10-20), with one continuous motion at the calibration current level. Then gradually decrease the test current until the moving contact assembly resets. This reset value should be between 85 and 95 percent of the AC pickup current.

INSTALLATION PROCEDURE

Location

The location of the relay should be clean and dry, free from dust, excessive heat, and vibration, and should be well lighted to facilitate inspection and testing.

Mounting

The relay should be mounted on a vertical surface. The outline and panel drilling dimensions are shown in Fig. 6.

Connections

Internal connections are shown in Fig. 5. For an elementary diagram illustrating a typical application of the NAA15E auxiliary relay refer to the instruction book for the associated Type GCXG ground distance relay.

Selection of Nominal Voltage

Before proceeding with the installation of the relay, be sure that the relay connections are correct for the nominal DC voltage with which the relay is to be applied. Table V in the section on ACCEPTANCE TESTS lists the circuit connections of the A<sub>1</sub>, A<sub>2</sub>, and A<sub>3</sub> units for 48, 125 and 250 volt nominal ratings. Note that the 125 and 250 volt ratings are handled by selecting the proper external connections. For 48 volts it is necessary to interchange the red leads on cradle block terminals 14, 15 and 16 with the green leads stored on the insulated standoffs (14A, 15A and 16A).

Inspection and Tests

If the relay has been stored for any length of time prior to installation, it is recommended that the visual and mechanical inspection points and the electrical tests listed under ACCEPTANCE TESTS be repeated.

Instantaneous Unit

At the time of installation the instantaneous unit should be set for the AC pickup amperes desired for the installation. This is accomplished by turning the knurled armature on the plunger rod until its lower edge lines up with the selected marking on the calibration tube. Where more accurate pickup settings are required an ammeter and AC test source should be used.

PERIODIC CHECKS AND ROUTINE MAINTENANCE

In view of the vital role of protective relays in the operation of a power system, it is important that a periodic test program be followed. It is recognized that the interval between periodic checks will vary depending upon environment, type of relay and the user's experience with periodic testing. Until the user has accumulated enough experience to select the test interval best suited to his individual requirements, it is suggested that the following points be checked at an interval of from one to two years.

1. Pick up of auxiliary units.
2. Operation of instantaneous unit.

The procedure outlined under ACCEPTANCE TESTS can be followed.

Contact Cleaning

For cleaning relay contacts a flexible burnishing tool should be used. This consists of a flexible strip of metal with an etched-roughened surface

resembling in effect a superfine file. The polishing action is so delicate that no scratches are left, yet it will clean off any corrosion thoroughly and rapidly. Its flexibility insures the cleaning of the actual points of contact. Do not use knives, files, abrasive paper or cloth of any kind to clean relay contacts.

### SERVICING

If it is found during the acceptance, installation or periodic test routines that any of the factory or field adjustments have been disturbed the settings can be restored as outlined in the following paragraphs.

#### Auxiliary Units

Contact gaps of the telephone-type auxiliary units (A<sub>1</sub>, A<sub>2</sub>, and A<sub>3</sub>) can be adjusted by bending the stationary contact brush to obtain the specified .010" - .015" gap. After this adjustment is made the wipe of the circuit-closing contacts should be checked to be sure it is still .005". Wipe can be restored by bending the moving contact brush as required.

If it is found that the voltage pickup of a unit is too high, it can be reduced by decreasing the gap between armature and pole face by bending the stop below the contact operating arm. To raise the pickup voltage, the armature gap should be increased. After this adjustment, it will be necessary to readjust the contacts to restore the .010" - .015" gap and the .005" wipe.

#### Overcurrent Unit

The instantaneous overcurrent unit is equipped with two normally open contacts. In the reset

position of the unit each contact should have a gap of approximately 1/16" measured between the moving and stationary contact tips. The stationary contact brush should be striking the lower stop arm with sufficient force to give an initial tension of approximately 5 grams. This is the force required at the stationary contact tip to just separate the brush from the lower stop arm.

Contact gap can be adjusted by bending the flexible stationary contact brush. The bend should be made just in front of the point where the brush strikes the lower stop. In the final adjustment the section of the brush adjacent to the contact tip should be parallel with the moving contact arm. The initial tension can be changed by bending the brush near the point where it is fastened to the base. If either gap or initial tension is changed, the other should be checked and readjusted if necessary.

The backstops above the stationary contact brushed should be set so that with the armature at maximum travel the backstop is deflected .003" to .005". The backstop can be adjusted by bending it near the point where it is fastened to the base.

### RENEWAL PARTS

It is recommended that sufficient quantities of renewal parts be carried in stock to enable the prompt replacement of any that are worn, broken, or damaged.

When ordering renewal parts, address the nearest Sales Office of the General Electric Company specify quantity required, name of the part wanted, and give complete nameplate data. If possible, give the General Electric requisition number on which the relay was furnished.





***Meter and Control  
Business Department***

---

2/92 (1000)

*General Electric Company  
205 Great Valley Parkway  
Malvern, PA 19355*