

SWITCHGEAR COMPONENTS

INSTRUCTIONS

TYPE L2
AUXILIARY SWITCHES

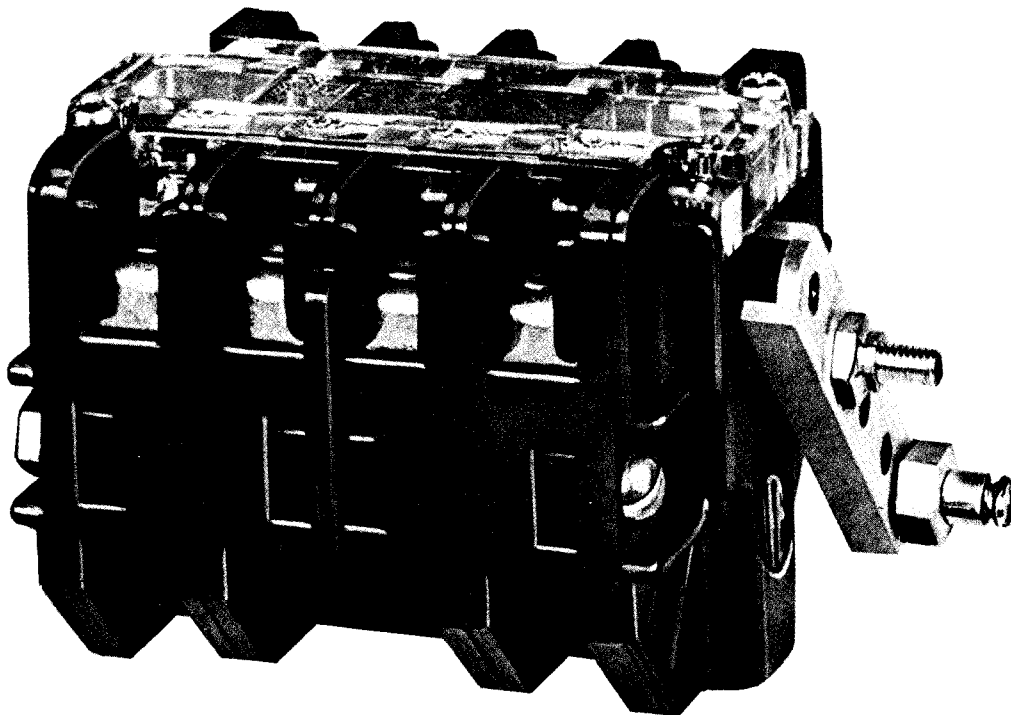

IFE Imperial Corporation

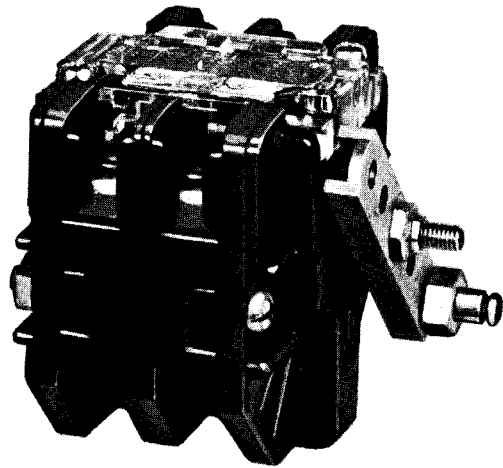

Fig. 1—Type L2 Auxiliary Switch, Two Contact

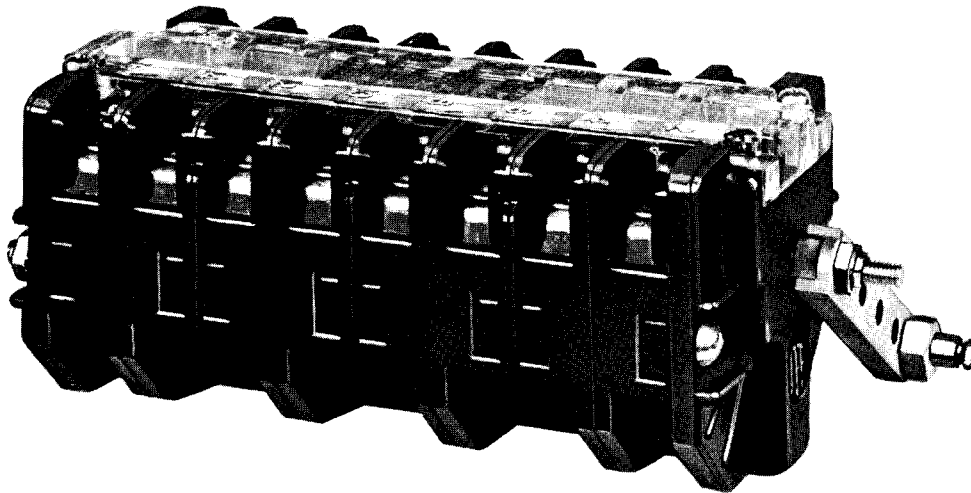

Fig. 2—Type L2 Auxiliary Switch, Eight Contact

These instructions do not purport to cover all details or variations in equipment nor to provide for every possible contingency to be met in connection with installation, operation, or maintenance. Should further information be desired or should particular problems arise which are not covered sufficiently for the purchaser's purposes the matter should be referred to the I-T-E Imperial Corporation.



AUXILIARY SWITCHES

TYPE L2

INTRODUCTION

The Type L2 auxiliary switch is a front-connected switch with double-break rotary contacts. The auxiliary switch can be furnished as a two, four, six, or eight contact unit.

The switch is "built-up" of a series of moldings which, when assembled, enclose the contact parts. The cover is molded of clear plastic so that it is not necessary to remove the cover to check the condition or operating sequence of the contacts.

The contacts are assembled on the shaft in any desired combination. That is, closed when the circuit breaker is closed "a"; or closed when the circuit breaker is open "b". Any contact can be removed from the shaft and rotated to change an "a" contact to a "b" contact, or a "b" contact to an "a" contact.

RATINGS

The switch contacts can carry 40 amperes continuously with limitations in interrupting as indicated in Table I. The interrupting rating for the various control voltages, listed in Table I, assume an inductance of the average trip coil.

TABLE I INTERRUPTING RATINGS

Circuit Voltage	Maximum Amperes
115 A-C	30
240 A-C	20
480 A-C	10
600 A-C	7
125 D-C	10
250 D-C	5
600 D-C	0.5

For highly inductive circuits, two contacts are sometimes placed in series.

RECEIVING AND STORAGE

RECEIVING

In general, auxiliary switches are usually mounted on a circuit breaker or other device. Auxiliary switches shipped separately for replacement purposes or for adding to existing equipment are completely assembled and packed in individual cartons. Immediately upon receipt, examine the switches for any damage sustained in transit. If injury or rough handling is evident, file a damage claim at once with the transportation company and promptly notify the nearest I-T-E Sales Office.

STORAGE

Individually packed switches for stock purposes or switches not for immediate installation should be left in the shipping carton and stored in a clean dry place.

DESCRIPTION

The Type L2 auxiliary switches are "built-up" of moldings which interlock and nest into each other. This assures that the moldings forming the body and cover of the switch can be assembled in only one way. The basic two contact switch consists of two end moldings, a stationary contact molding with contacts, two rotating contact moldings with contacts and retainers, two bearing moldings, cover molding, shaft, and the necessary assembly hardware.

The four, six, and eight contact auxiliary switches are formed by adding an interphase molding, one stationary contact molding with contacts, two rotating contact assemblies, and a longer shaft and cover for each additional two contacts required.

CONTACTS

The stationary contacts are positioned and held in place by cavities in the stationary contact moldings. These contacts also carry the contact terminal screws.

The movable contacts are positioned by a projection on the stationary contact; and the contact movement, in the open contact position, is limited by a projection on the contact molding. Each movable contact is "backed-up" by a contact spring which furnishes the necessary contact pressure. Movement of the movable contact produces contact wipe at its pivot which assures a low resistance contact with the stationary contact.

Each rotating contact is assembled on a rotating molding and held in position by a contact retainer. The complete rotating contact assembly is then positioned on a square shaft that rotates on bearings in the end moldings. The shaft opening in the contact molding is so formed that the contact molding can be placed in any one of three positions in each of the four quadrants of the shaft. If we assume that the vertical and horizontal axes forming the quadrants pass through the diagonals of the square shaft, the contact moldings can be positioned on the shaft so that the center line of the contacts is on the diagonals or at 22 degree spacings on either side of the diagonals. Standard short contacts, "a" or "b", will always have their center lines on the diagonals; while ("early make" and "late break") advanced long contacts ("a" or "b") will always have their center lines on the 22 degree spacings at either side of the diagonals.

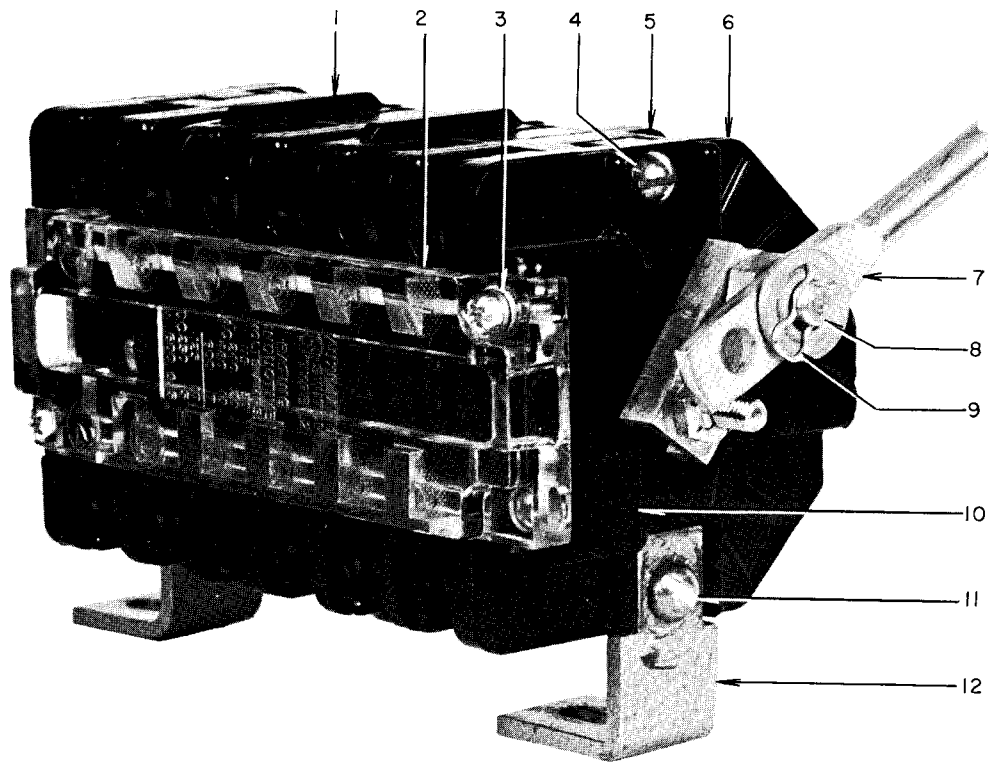

- | | |
|-----------------------|---------------------|
| 1. Interphase Molding | 7. Operating Link |
| 2. Cover | 8. Stud |
| 3. Screw | 9. Hair Pin Cotter |
| 4. Screw | 10. Bearing Molding |
| 5. Contact Molding | 11. Screw |
| 6. End Molding | 12. Mounting Feet |

Fig. 3—Type L2 Auxiliary Switch, Six Contact Showing Mounting and Operating Parts

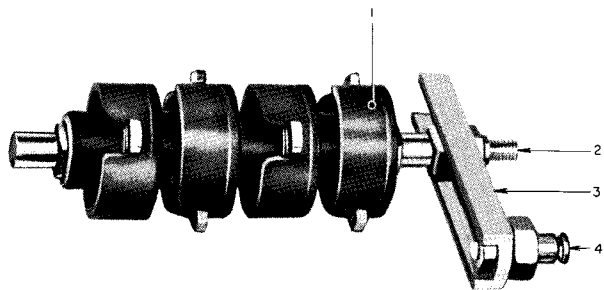

1. Rotating Contact Assembly
2. Shaft
3. Crank
4. Stud

Fig. 4—Assembly of Rotating Parts for Four-Contact Type L2 Auxiliary Switch

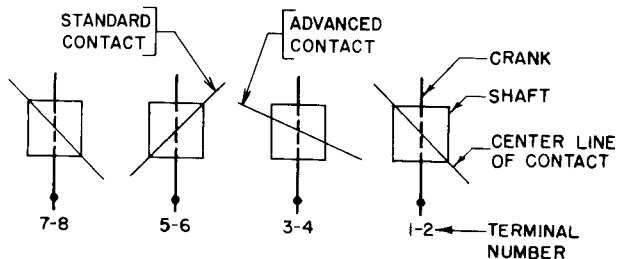

Fig. 5—Sketch Showing Center Line of Contacts Relative to Position of Shaft and Operating Crank, Viewed From End Opposite the Crank



TERMINAL IDENTIFICATION

The switch terminals are identified by means of raised numbers on the cover molding. Starting with the terminals at the crank end of the switch, the terminals on the right-hand side when facing the crank are given odd numbers beginning with one; while the contacts on the left-hand side are given even numbers beginning with two.

OPERATION

The Type L2 auxiliary switches are operated by a crank mounted on the switch shaft which is connected by an adjustable linkage to the circuit breaker. The crank and linkage are designed so that the opening and closing of the circuit breaker rotates the switch shaft 90 degrees. This rotation of the shaft opens the normally closed "b" contacts when the breaker closes and closes the normally open "a" contacts. The contact operation is reversed as the circuit breaker opens; that is, the "b" contacts close and the "a" contacts open.

MAINTENANCE

The Type L2 auxiliary switches require very little maintenance. However, it is recommended that the following be inspected every six months and whenever the circuit breaker is de-energized for inspection or maintenance.

CONTACTS

A visual inspection of the contacts can be made through the clear molded cover. If the contacts show signs of burning or pitting, dis-assemble the switch and replace the necessary parts as described under REPAIR AND REPLACEMENT.

REPAIR AND REPLACEMENT

A minimum amount of work is required to dis-assemble the Type L2 auxiliary switches. Should it become necessary to replace contacts or other parts of the switch, proceed as described in the following sections.

Rotating Contact Assembly

To replace or change the rotating contact assemblies, proceed as follows:

1. Trip the circuit breaker and de-energize the control circuit.
2. Tag all leads with their correct terminal number and remove the leads.
3. Refer to Fig. 3 and remove hairpin cotter (9) (and spacers, if used) from crank stud (8) and remove the switch operating link (7).
4. Remove screw (11) fastening switch to mounting feet (12) and remove the complete switch. (NOTE: On switches mounted without feet, remove two self tapping screws fastening switch to mounting plate).

5. Remove two screws (3) fastening cover (2) to switch and remove cover.

6. Remove two screws fastening bearing moldings (10) to end moldings (6) and remove the bearing moldings.

7. Remove the shaft, operating crank, and rotating contacts as a complete assembly. (See Fig. 4).

CAUTION: BEFORE REMOVING THE ROTATING CONTACT ASSEMBLIES FROM THE SHAFT, MAKE A SKETCH (SIMILAR TO THAT SHOWN IN FIG. 5) SHOWING THE POSITION OF THE CENTER LINE OF THE CONTACTS RELATIVE TO THE DIAGONALS OF THE SHAFT AND POSITION OF THE OPERATING CRANK. THIS IS IMPORTANT IF A CONTACT REMOVED AS AN "a" (OR "b") CONTACT IS TO BE REPLACED AFTER DIS-ASSEMBLY IN ITS CORRECT POSITION ON THE SHAFT AS AN "a" (OR "b") CONTACT.

The simplified sketch as shown in Fig. 5, would be typical of that made for a four contact switch having an "a" contact at terminals 1 and 2, and advanced "a" contact at terminals 3 and 4, a "b" contact at terminals 5 and 6, and an "a" contact at terminals 7 and 8. When making this sketch, hold the complete assembly, shown in Fig. 4, so that the operating crank is perpendicular to the floor and facing away from you.

8. Start with the contact assembly at the end of the shaft opposite the operating crank. Sketch the position of the contact and then remove it. Continue this procedure with each contact assembly until all the assemblies are removed from the shaft.

Replace the rotating contact assembly (1, Fig. 4) as a complete unit if either the contacts are pitted or if the contact molding is carbonized due to arcing or damaged in any way. Follow the sketch made during dis-assembly when replacing the rotating contact assemblies on the shaft. This assures correct contact sequence and switch operation.

Care must be taken, when replacing the shaft, operating crank, and rotating contacts as a complete unit, to make sure the crank and switch terminals one and two are at the same end of the switch.

Re-assemble the switch parts and replace it on the circuit breaker by following the reverse of the procedure described in steps 1 to 8 above.

Movable and Stationary Contact

To replace the movable or stationary contacts, proceed as follows:

1. Proceed with and follow steps 1 to 8 as described under Rotating Contact Assembly.
2. Remove the one remaining screw (4, Fig. 3) fastening the switch moldings together. (NOTE: On switches not mounted on mounting feet, it is necessary to remove two screws).
3. Separate the end moldings (6, Fig. 3), and contact moldings (5, Fig. 3); and, if the switch has more than two contacts, the interphase moldings (1, Fig. 3).

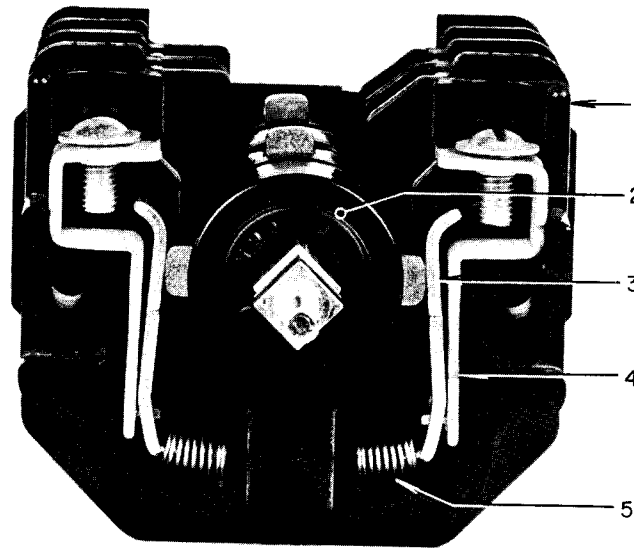

1. Contact Molding
2. Rotating Contact Assembly
3. Movable Contact
4. Stationary Contact
5. Contact Spring

Fig. 6—Type L2 Auxiliary Switch with End Molding, Cover, and Operating Crank Removed

4. The movable contacts (3, Fig. 6), stationary contacts (4, Fig. 6), and contact springs (5, Fig. 6) are easily removed from the cavities in the contact molding, by lifting each contact assembly up and away from the molding. (NOTE: Care must be taken when removing the contacts to prevent loss of the contact spring. It is suggested that the thumb or finger be placed over the spring while the contacts are being removed).

Replace any pitted or burned contacts and examine the moldings for signs of burning or breaking. Re-assemble the parts following the reverse of the procedure described in steps 1 to 4 above.

CAUTION: BEFORE REPLACING THE BEARING AND COVER MOLDINGS, CHECK AND MAKE SURE THE OPERATING CRANK AND TERMINALS ONE AND TWO WILL BE AT THE

SAME END OF THE SWITCH WHEN THE ASSEMBLY IS COMPLETE.

RENEWAL PARTS

It is recommended that complete switches be carried in stock for the prompt replacement of Type L2 auxiliary switches. Additional renewal parts may be stocked to facilitate the repair of auxiliary switches after removal from the circuit breaker.

When ordering complete switches, specify the type of switch, number of contacts and contact code, type of circuit breaker on which it is to be mounted, and whether it is to be right-hand or left-hand mounted.

When ordering renewal parts, specify the type of switch, description of parts, and quantity required.



NOTES



ITE Imperial Corporation